

# PREFACE

Thank you for purchasing the GP Screen Editor Software, "GP-PRO/PB III for Windows Ver. 7.2" for use with Pro-face's GP series programmable operator interfaces.

Please read this manual carefully in order to use this software properly, and be sure to keep this manual handy for future reference.

## NOTES

- (1) The copyrights to all programs and manuals included in the GP-PRO/PB III for Windows Ver. 7.2 (hereinafter referred to as "this product") are reserved by the Digital Electronics Corporation. Digital grants the use of this product to its users as described in the "Software Operating License Conditions" documentation, included with this product's CD-ROM. Any actions violating the above-mentioned conditions are prohibited by both Japanese and foreign regulations.
- (2) The contents of this manual have been thoroughly inspected. However, if you should find any errors or omissions in this manual, please inform your local GP representative of your findings.
- (3) Regardless of article (2), the Digital Electronics Corporation shall not be held responsible for any damages or third party claims resulting from the use of this product.
- (4) Differences may occur between the descriptions found in this manual and the actual functioning of this product. Therefore, the latest information on this product is provided in data files (i.e. Readme.txt files, etc. ) and in separate documents. Please consult these sources as well as this manual prior to using the product.
- (5) Even though the information contained in and displayed by this product may be related to intangible or intellectual properties of the Digital Electronics Corporation or third parties, the Digital Electronics Corporation shall not warrant or grant the use of said properties to any users and/or other third parties.
- (6) The specifications set out in this manual are for overseas products only. As a result, some differences may exist between the specifications given here and for those of the identical Japanese product. Digital Electronics Corporation accepts no liability for issues related to the intellectual property rights of third parties or any issues related to the use of the information contained in or displayed by this product.

© Copyright 2005 Digital Electronics Corporation. All rights reserved.  
Digital Electronics Corporation, February 2005

For the rights to trademarks and trade names, see "TRADEMARK RIGHTS".

# TRADEMARK RIGHTS

All company or product names used in this manual are the trade names, trademarks (including registered trademarks), or service marks of their respective companies.

This product omits individual descriptions of each of these rights.

Trademark / Trade Name	Right Holder
Microsoft, MS, MS-DOS, Windows, Windows 95, Windows 98, Windows Me, Windows NT, Windows 2000, Windows XP, Windows Explorer, Microsoft Excel	Microsoft Corporation, USA
Intel, Pentium	Intel Corporation, USA
Pro-face	Digital Electronics Corporation (in Japan and other countries)
Ethernet	Western Digital Electric Corporation, USA
IBM, VGA, IBM Compatible	International Business Machines Corporation (IBM), USA

The following terms differ from the above mentioned formal trade names and trademarks.

Term used in this manual	Formal Trade Name or Trademark
Windows 95	Microsoft® Windows®95 Operating System
Windows 98	Microsoft® Windows®98 Operating System
Windows Me	Microsoft® Windows®Me Operating System
Windows NT	Microsoft® Windows NT® Operating System
Windows 2000	Microsoft® Windows® 2000 Operating System
Windows XP	Microsoft® Windows®XP Operating System

# LIST OF SUPPORTED MODELS

The GP-PRO/PBIII for Windows Ver. 7.2 functions and settings available will vary, depending on the model of GP used. Use the following table to identify your GP.

## ■ List of GP Series Products

Series		Product Name	Model	GP Type	
GP70 series	GP-H70 series	GP-H70L	GP70-LG11-24V GP70-LG41-24VP	GP70L	
		GP-H70S	GP70-SC11-24V GP70-SC41-24VP	GP70S	
	GP-270 series	GP-270L	GP270-LG11-24V	GP270-LG21-24VP	GP270L
			GP270-LG31-24V	GP270-SC11-24V	
			GP270-SC21-24VP	GP270-SC31-24V	
	GP-270S	GP270-SC11-24V	GP270-SC21-24VP	GP270S	
		GP270-SC31-24V	GP370-LG11-24V		
		GP370-LG21-24VP	GP370-LG31-24V		
	GP-370 series	GP-370L	GP370-LG11-24V	GP370-LG21-24VP	GP370L
			GP370-LG31-24V	GP370-LG41-24VP	
			GP370-SC11-24V	GP370-SC21-24VP	
			GP370-SC31-24V	GP370-SC41-24VP	
	GP-370S	GP370-SC11-24V	GP370-SC21-24VP	GP-370S	
		GP370-SC31-24V	GP370-SC41-24VP		
	GP-470 series	GP-470E	GP470-EG11	GP470-EG21-24VP	GP470
			GP470-EG31-24V	GP570-LG11-24V	
			GP570-LG21-24V	GP570-SC11	
	GP-570 series	GP-570L	GP570-LG11-24V	GP570-LG21-24V	GP570L
			GP570-SC11	GP570-SC21-24VP	
			GP570-SC31-24V	GP570-TC11	
			GP570-TC11	GP570-TC21-24VP	
			GP570-TC31-24V	GP570-TC41-24VP	
			GP57J-SC11	GP570VM	
GP-570VM	GP570-TV11	GP570VM			
	GP571T	GP571-TC11	GP571T		
GP-571 series	GP-571T	GP571-TC11	GP571T		
	GP-675 series	GP-675S	GP675-SC11	GP675	
GP-675T		GP675-TC11			
GP-675 series	GP-675S	GP675-SC11	GP675		
	GP-675T	GP675-TC11			
GP-675 series	GP-675S	GP675-SC11	GP675		
	GP-675T	GP675-TC11			
GP-675 series	GP-675T	GP675-TC41-24VP	GP675		
GP-870 series	GP-870VM	GP870-PV11	GP870VM		
GP-37W2 series	GP-37W2B	GP37W2-BG41-24V	GP37W2		
GP-377 series	GP-377L	GP377-LG11-24V	GP377-LG41-24V	GP377L	
		GP377-SC11-24V	GP377-SC41-24V		
		GP377-SC41-24V	GP377R-TC11-24V		
GP-377R series	GP-377RT	GP377R-TC11-24V	GP377R-TC41-24V	GP377R	
		GP477R-EG11	GP477R-EG41-24VP		
GP-477R series	GP-477RE	GP477R-EG11	GP477R-EG41-24VP	GP477R	
		GP577R-SC11	GP577R-SC41-24VP		
GP-577R series	GP-577RS	GP577R-SC11	GP577R-SC41-24VP	GP577R	
		GP577R-TC11	GP577R-TC41-24VP		
		GP577RT	GP577R-TC41-24VP		

LIST OF SUPPORTED MODELS

Series		Product Name	Model	GP Type
GP2000H series	GP-2301H series	GP-2301HL	GP2301H-LG41-24V	GP2301HL
		GP-2301HS	GP2301H-SC41-24V	GP2301HS
	GP-2401H series	GP-2401HT	GP2401H-TC41-24V	GP2401H
GP2000 series	GP-2300 series	GP-2300L	GP2300-LG41-24V	GP2300L
		GP-2300S	GP2300-SC41-24V	GP2300S
		GP-2300T	GP2300-TC41-24V	GP2300
	GP-2301 series	GP-2301L	GP2301-LG41-24V	GP2301L
		GP-2301S	GP2301-SC41-24V	GP2301S
		GP-2301T	GP2301-TC41-24V	GP2301
	GP-2400 series	GP-2400T	GP2400-TC41-24V	GP2400
	GP-2401 series	GP-2401T	GP2401-TC41-24V	GP2401
	GP-2500 series	GP-2500L	GP2500-LG41-24V	GP2500L
		GP-2500S	GP2500-SC41-24V	GP2500S
		GP-2500T	GP2500-TC11 GP2500-TC41-24V	GP2500
	GP-2501 series	GP-2501L	GP2501-LG41-24V	GP2501L
		GP-2501S	GP2501-SC11	GP2501S
		GP-2501T	GP2501-TC11	GP2501
GP-2600 series	GP-2600T	GP2600-TC11 GP2600-TC41-24V	GP2600	
GP-2601 series	GP-2601T	GP2601-TC11	GP2601	

■ List of GLC Series Products

Series		Product Name	Model	GP Type
GLC100 series	GLC100 series	GLC100L	GLC100-LG41-24V	GLC100L
		GLC100S	GLC100-SC41-24V	GLC100S
GLC300 series	GLC300 series	GLC300T	GLC300-TC41-24V	GLC300T
GLC2000 series	GLC2300 series	GLC2300L	GLC2300-LG41-24V	GLC2300L
		GLS2300T	GLC2300-TC41-24V	GLC2300
	GLC2400 series	GLC2400T	GLC2400-TC41-24V	GLC2400 <sup>1</sup>
	GLC2500 series	GLC2500T	GLC2500-TC41-24V	GLC2500
			GLC2500-TC41-200V	
GLC2600 series	GLC2600T	GLC2600-TC41-24V GLC2500-TC41-200V	GLC2600 <sup>1</sup>	

\*1 When selecting the GP Type from the Project Manager, be sure to check the Revision Seal on the back of your GLC unit for the Revision Code. If there is no code or the code is "1", select "Rev.\* None, 1". If your revision code is 2 or higher, select "Rev.\* Above 2". For details, refer to your GLC Series User Manual.

■ List of Supported STs

Series	Product name	Model	GP Type
ST series	ST 400	ST 400-AG41-24V	ST 400
	ST 401	ST 401-AG41-24V	ST 401
	ST 402	ST 402-AG41-24V	ST 402
	ST 403	ST 403-AG41-24V	ST 403

### ■ List of Supported LTs

	Series	Type	Model	GP Type
LT series	LT Type A series	LT Type A1	GLC 150-BG41-XY32SK-24V	LT TypeA
		LTC Type A1	GLC 150-SC41-XY32SK-24V	LTC TypeA
		LT Type A2	GLC 150-BG41-XY32SC-24V	LT TypeA
	LT Type B/B+ series	LT Type B	GLC 150-BG41-FLEX-24V	LT TypeB/B+
		LT Type B+	GLC 150-BG41-XY32KF-24V	
		LTC Type B+	GLC 150-SC41-XY32KF-24V	LTC TypeB+
	LT Type C series	LT Type C	GLC 150-BG41-RSFL-24V	LT TypeC
	LT Type H series	LT Type H1	GLC 150-BG41-ADK-24V	LT TypeH
			GLC 150-BG41-ADPK-24V	
			GLC 150-BG41-ADTK-24V	
		LTC Type H1	GLC 150-SC41-ADK-24V	LTC TypeH
			GLC 150-SC41-ADPK-24V	
			GLC 150-SC41-ADTK-24V	
		LT Type H2	GLC 150-BG41-ADC-24V	LT TypeH
			GLC 150-BG41-ADPC-24V	
GLC 150-BG41-ADTC-24V				

### ■ List of Supported Factory Gateway

Product name	Model	GP Type
Factory Gateway	FGW-SE41-24V	Factory GatewayFGW-SE



**Note:** To use the GPWeb and GPViewer functions with the Factory Gateway, you must have GPPRO/PB III C-Package02 or later installed.

# NEW FEATURES OF VERSION 7.0

The upgrade from GP-PRO/PB III for Windows Ver. 6.3 to Ver. 7.0 adds the following new features. These include new functions Q-tag Alarm and Keypad Input Display, Text Screens using Multi-Language Displays and others. The following explanation gives a brief overview of these features.

## <For all models>

### ◆ Transparent Text Background

The background color of the text can be set to "Transparent".

▼ **Reference** ▲ *2.2.9 Text*

### ◆ Adjustment of Touch Panel Scan Sensitivity

The GP unit's touch panel scan sensitivity can be set to any of three levels - [High], [Medium], or [Low].

This can be set only via the GP unit's OFFLINE screens ([GP SETUP] → [EXTENDED FEATURES] → [TOUCH PANEL FEATURES]).

▼ **Reference** ▲ *6.1 Registering GP Initial Settings - GP System Settings*

### ◆ Import/Export of Text (X) Screen

Data in a Text (X) Screen can be exported to an external file (\*.csv, \*.txt), or an external file can be imported to a Text (X) Screen.



- **The Import/Export function of Text Screens for Multi-Language Displays is supported only by GP-377, GP77R and GP2000 Series units.**

▼ **Reference** ▲ *3.4.3 Text Screens Importing/Exporting*

## <For GP-377, GP77R/GP2000 Series units only>

### ◆ Selection and transfer of System Screen

When sending data to the GP unit (Numeric Input Popup Keypad, CSV Display, File Manager Display - Explorer Screen), this feature can select and send only the minimum number of required items. The result is a reduction of unnecessary data and a reduction of file transfer time. For System Screen settings, ▼ **Reference** ▲ *7.2.1 Transfer Settings - Setup Method*

### ◆ Text Table Converter

When text table character strings used in a screen or Part's label, or in an alarm character string are designated directly, they can all be converted at once for use in a string table by assigning index numbers and registering them.

All of a project file's screen and Part labels, as well as alarm character strings can be converted at once with this feature. Also, only the desired portion of Direct Text strings can be converted by specifying the screen to be converted.

**▼ Reference ▲** *4.6.4 Text Table Converter*

◆ *Display of Participatory Node Name for Transfer via Ethernet*

When transferring data using the "Ethernet" option, the IP Address and participatory Node name (the name of the GP to which the network project file is transferred using the Pro-Server with Pro-Studio) are displayed.



- Note:** • Ethernet I/F units are required for the GP77R, GP-2501, and GP-2601 series units.

**▼ Reference ▲** *Pro-Server with Pro-Studio for Windows Operation Manual 7.4 Setting up the GP via an Ethernet Network*

<GP-2000 Series Units Only>

◆ **New Security and Time Schedule Features**

Security and Time Schedule features previously available only in ST units are now available in all GP2000 Series units.

Security Feature: **▼ Reference ▲** *4.7 Security Feature*

Time Schedules: **▼ Reference ▲** *4.8 Time Schedules*

◆ **Additional Q-tag Alarm Features (Increased number of blocks, Alarm Occurrence Number Count Display, Alarm Occurrence Time's Accumulated Time Display, Alarm Message Level Settings and Level Identification Colors, Alarm Sort Display, Alarm Display Cursor Position/Cursor Movement ID Information Settings, External Operation Alarm Occurrence Frequency/Accumulated Time Clear)**

The Q-tag alarm feature has been expanded to include the following:

- Up to 8 blocks can be used for alarms.
- Can display accumulated count data for Q-tag alarm occurrences, as well as occurrence times.
- Colors and levels (0 to 7 - total of 8) can now be set for alarm messages.
- Alarm contents can now be sorted.

Ex. Order can be set for Occurrence Time, Occurrence Frequency, Levels or Dates.

**▼ Reference ▲** *Tag Reference Manual 2.23.3 Setting Items ■ Operation Mode/Special*

- When a Q-tag Alarm's cursor position (address) is designated, touching the [Alarm Acknowledge Key (use T-tag)] will write to the designated address, using the alarm's registration code. (Set via the Alarm Editor) Also, if the [Notify ID at each cursor movement.] is enabled, the currently selected Alarm's registration number will be written to the designated address, without pressing the Alarm Acknowledge key.

For Alarm Acknowledge Key details, **▼Reference▲** *Tag Reference Manual 2.23.3 Setting Items ■ Operation Mode/Special*

- The Q-tag Alarm Occurrence Frequency and Accumulated Time data is cleared from via either the Device PLC's control command or a D-Script command.

**▼Reference▲** *For Additional Q-tag Alarm Features, Tag Reference Manual 2.20 Alarm Summary bit log/word log Display Extended Feature <Q-tag>, Operation Manual 5.1 Alarm Creation and Editing*

◆ **Keypad Input Display Extended Features (Keyboard Selection for Touch Input, Specify entering order and Group No, Specify arrangement position, Input Completed Alert Bit)**

The following features have been added to the Keypad Input Display feature.

- Instead of the previous style of data entry where a [Bit] turning ON would trigger the Keypad to wait for input, a new feature [Touch] can be used to activate the Keypad for touch input. This feature can also be used to select if the Popup Keypad is used or not. Selecting [Exists] allows you to designate the position of the Popup Keypad. Selecting [None] allows you to use a standard PC keyboard.



**Note:** • **The Touch area's [Use Keypad] can be used normally with GP-377, GP77R, and GP2000 Series units, however the Popup Keypad's [Specify arrangement position] feature can only be used with GP2000 Series units.**

- **The [Touch] area's [None] feature is available only on GP2000 Series units.**
- When using [Touch] to start data entry, you can also specify the entering order and the Group No. After entry is completed in one area, this feature moves the keypad's data entry cursor in the designated order to the next area. Also, you can designate the desired group number. Thus, when multiple Keypads are used, the cursor will move in the order designated for each individual Group No.
- You can designate the position the Popup Keypad appears in.
- You can use either the [Touch] or the [Bit] commands' [Input Completion] feature to inform the Device/PLC that entry is finished.

For Keypad Input Display details, **▼Reference▲** *2.1.14 Keypad Input Display*



◆ **Text Display screens can now use the Multi-Language Display feature.**

Text for the Multi-Language Display function can be entered and saved on the Text (X) Screen as separate tables. Up to 16 tables can be entered and saved per Text Screen.

For details concerning Text Screen Multi-language Features,

▼ **Reference** ▲ *3.4.2 Editing MultiLanguage Text Screens*

◆ **Selectable Character Type for the N/E/P/d/S-tags**

The style of characters for the N, E, P, d, and S-tags can be selected from the "Normal", "Bold" and "Raised" options.

When "Raised" is selected, the color for shading can also be specified.

▼ **Reference** ▲ *Tag Reference Manual Settings Parameters section of each Tag ■ Size/Style*

◆ **L-tag image screen (\*.bin) file name display**

Only when the L-tag's [Screen Designation] is set to [Indirect] and [Data Type] is set to [Text] will the file names of the CF Card's output folder files or the CF Card's internal image (\*.bin) files be displayed. The filenames can be changed to make them descriptive and easy to understand.

▼ **Reference** ▲ *Tag Reference Manual 2.14.3 (L-tag) Setting Items - Screen Designation/Indirect*

◆ **D-Script/Extend SIO Script Function Additions**

The following D-Script/Extend SIO Script Memory Operation Command and CF File Operation Command functions have been added.

Command	Added Function
<b>Memory Operation</b>	Memory Shift
	Memory Link
	Memory Search
	Memory Compare
<b>CF File Operation</b>	CSV File Read

For details, ▼ **Reference** ▲ *Tag Reference Manual 3.1 D-Script/Global D-Script, 3.2 Extended SIO Script*

■ **New Device/PLC Protocols**

- Hitachi Industrial Equipment Systems SJ300/L300P Series Inverters
- Hitachi Industrial Equipment Systems EH-150 Unit 1:1/1:n Device Additions
- SIEMENS SIMATIC S7 Ethernet
- Schneider Modbus TCP Ethernet
- Schneider Modbus RTU 1:n
- Schneider UniTelWay Modbus RTU
- Rockwell (Allen Bradley) Compact Logix Ethernet
- FATEK FACON Device Addition

**Reference** *Device/PLC Connection Manual*

# NEW FEATURES OF VERSION 7.1

The upgrade from GP-PRO/PB III for Windows Ver. 7.0 to Ver. 7.1 adds the following new features.

## <For all models>

### ◆ Information Data Color Selection

Screen information character colors can be used to designate Tag Names, Parts ID numbers and Device Addresses.

▼ **Reference** ▲ *2.10.2 Screen Property Settings*

## <For GP2000 Series units only> (Not including GP2000H units)

### ◆ Time-Base Function

The new Time-Base function can be used for Keypad Input Displays and Numeric Displays. The “Time-Base” function is built into Siemens Co. PLC units. This function displays the top four bits of hex data, with the number indicated by the remaining 12 bits being displayed using 3 digits of BCD data. Four Time-Base modes are available: 0.01s, 0.1s, 1s and 10s. The 3 places of BCD data are the decimal point data, followed by a space or a “0”, for a total of 4 digits. Seconds units are always displayed.

▼ **Reference** ▲ *2.1.14 Keypad Displays, 2.1.21 Numeric Displays*

### ◆ CF Write Mode Function

Using the CSV Data Transfer Function, you can select the method used when writing data to a CF Card. Selections include either writing all of a file’s contents, or only overwriting data. Only overwriting data allows the accumulation of title data (ITEM NAME).

▼ **Reference** ▲ *Tag Reference Manual 4.4.3 List of Condition Settings*

## ■ New Device/PLC Protocols

- Toshiba Schneider Inverter VF-S9, VF-nC1, VF-S11, VF-A7 Series Inverters
- HITACHI S10V Series Ethernet
- FUJI MICREX-SX Series
- YOKOGAWA FCN/FCJ Series
- Ubon UPZ Series

▼ **Reference** ▲ *Device/PLC Connection Manual*

# NEW FEATURES OF VERSION 7.2

The upgrade from GP-PRO/PB III for Windows Ver. 7.1 to Ver. 7.2 adds the following new features.

## ■ New model supported

### ◆ ST403 Units

- Featuring RS-232C/RS-422 selectable serial interface
- Featuring Ethernet interface
- Featuring two colors (amber and red) for the backlight

## ■ New functions

### <For all models>

### ◆ Support of Function Switch for Q-tag Selection Key

The Q-tag Selection keys that have been created using T-tag can be created using Function switches.

**Reference** 2.1.3 *Function Switches*

### ◆ Equal Layout of Multiple Copies

When making multiple copies of an object, the duplicated objects are automatically aligned with equal spacing in the area selected with the mouse.

**Reference** 2.4.7 *Duplicate*

### ◆ Centering of Part Labels

A repositioned label can be returned to the center with one-button operation.

**Reference** 2.1 *Parts* ■ *Creating Labels*

### <For GP2000 Series and ST Series units only>

### ◆ Global Interlock

Touch panel or function keys become enabled only when the condition (ON or OFF) of the specific bit address is being satisfied. When the condition is not satisfied, entries from the touch panel and function keys are disabled.

**Reference** 2.9 *Global Interlock*

**<For GP2000 Series (except for GP-2000H Series) and ST Series units only>****◆ Supporting Models and Protocols for Time-Base Function**

The Time-Base function can be used with ST Series units.

The function can also be used with the PROFIBUS-DP protocol.

The Time-Base function is featured in SIEMENS PLCs (S5 and S7 Series).

**▼ Reference ▲** *2.1.14 Keypad Display, 2.1.21 Numeric Displays*

**<For ST403 only>****◆ Backlight Color Change**

The backlight of the ST403 features two colors: amber and red. By switching the colors of the backlight, alarms and other information can be expressed without using the buzzer, sound outputs, or screen displays.

**▼ Reference ▲** *2.12.2 Backlight Color Change*

**■ New Device/PLC Protocols**

- HIOKI E.E. Smart Site Series Ethernet
- GE Fanuc Automation Series 90-30/90-70 Ethernet
- Mitsubishi MELSEC-QUTE Series Direct-coupled protocol

**▼ Reference ▲** *Device/PLC Connection Manual*

# HOW TO USE THIS MANUAL

## ■ Structure of the Manual CD-ROM

The "Operation Manual" is the first of four manuals for this product and explains how to use the "GP-PRO/PB III for Windows Ver. 7.2" software (hereinafter referred to as "this product"). Please refer to all of the manuals named below when using this product. These manuals can be found as PDF files in your "Manual CD-ROM" (CD #2).

In addition to these manuals, data files containing supplemental information on updated functions are also provided. To read these additional data files, click on the [Start] button in your Windows OS main screen and select the [Programs]→[Pro-face]→[ProPB3 C-Package] menu. Then, click on the [Read Me] selection.

For detailed information about GP series products, please refer to each GP's "User Manual". (Optionally available)

<b>vol. 1</b>	<b>Operation Manual (this manual)</b>	Describes this product's operation procedures and all standard functions. (provided as PDF data)
<b>Vol. 2</b>	<b>Tag Reference Manual</b>	Describes the function of and detailed settings for all GP-PRO/PBIII Tags. (provided as PDF data)
<b>Vol. 3</b>	<b>Parts List</b>	Describes this product's pre-made Parts and symbols. (provided as PDF data)
<b>Vol. 4</b>	<b>Device/PLC Connection Manual</b>	Describes the methods for connecting the GP to supported devices from other manufacturers. (provided as PDF data)

Screen Data Layout Sheets are useful for designing tag address settings, etc. and example sheets are installed as part of the GP-PRO/PBIII for Windows standard installation.

The following two layout sheets, "Device Allocation Table" and "Tag Layout Sheet", are in Microsoft Excel format and are located in the PDF Manual CD-ROM.

The following folder and file names are used.

Folder Name	File Name	Contents
Pro-face\ propbwin\sheet	Device1E.xls	Device Allocation Table
	TAG1E.xls TAG2E.xls TAG3E.xls TAG4E.xls	Tag Layout Sheet

For information on the use of Microsoft Excel, please refer to the Excel software's User Manual.

## ■ Designation of Supported Models

The functions and settings supported by each model may vary depending on the supported models. In this manual, explanations given are based on the variation of the "Series" and "Product name" described in the "List of Supported Models".

## ■ Chapter Breakdown

This manual contains 12 chapters and an appendix.  
The following is a general description of each chapter:

### ◆ CHAPTER 1: FUNDAMENTALS OF GP-PRO/PB III FOR WINDOWS

This chapter describes GP-PRO/PBIII usage from start to finish. Also explains the overall structure of the GP-PRO/PBIII Project Manager and Screen Editor areas.

### ◆ CHAPTER 2: CREATING BASE SCREENS

This chapter describes the basic operations and terminology used for drawing functions, such as “Part”, “Tag”, “Library”, and “D-Script”.

### ◆ CHAPTER 3: DRAWING APPLICATIONS: CREATING and USING SCREENS

This chapter describes the procedures for creating and using various screens, such as the M, T, K, X, I and V screens, which enable you to create high-quality images and provide advanced-level functionality.

### ◆ CHAPTER 4: SCREEN AND PROJECT MANAGEMENT

This chapter describes the procedures for editing and saving created screens and project files, and information management procedure.

### ◆ CHAPTER 5: CREATING AND EDITING ALARMS

This chapter describes the alarm creating and editing procedures.

### ◆ CHAPTER 6: GP INITIAL AND SYSTEM SETTINGS

This chapter describes the initial setup procedure required to use a GP series display unit.

### ◆ CHAPTER 7: TRANSFERRING DATA

This chapter describes the procedure for sending created screens to a GP series display unit.

### ◆ CHAPTER 8: SIMULATION

This chapter describes the procedures for simulating the operation between a GP series panel and a PLC.

### ◆ CHAPTER 9: PRINTING

This chapter describes the procedure for printing created screens.

### ◆ CHAPTER 10: ADVANCED FEATURES

This chapter describes the procedures for using GP-PRO/PBIII’s advanced functions such as sound output, filing data (recipe), CSV data transfer function, logging functions, and CF Card usage. For the detailed information, refer to Volume 3, Tag Reference Manual.

### ◆ CHAPTER 11: PROJECT MANAGER HIERARCHICAL DISPLAY

This chapter describes the procedures for using the Project Manager in hierarchical display mode.

### ◆ CHAPTER 12: DATA COMPATIBILITY

This chapter describes the procedure for converting existing screens created with older generation screen editor software (e.g. GP-PRO, GP-PRO II, GP-PRO III, Parts Box) with GP-PRO/PB III for Windows.

◆ **APPENDIX**

• **Error Messages**

Lists the error messages that will be displayed during operation of this product.

• **Troubleshooting**

Provides problem diagnosis and suggests solutions for errors and software operation problems.

• **Address Conversion Tables**

Lists the addresses available for each manufacturer's supported models.

• **Software Trouble Report**

If a software problem persists, even after using the Troubleshooting section, write down information about the problem using this sheet and send it by fax to your local Pro-face support center.



# MANUAL SYMBOLS AND TERMINOLOGY





This manual uses the following symbols and terminology.

If you have any questions about the contents of this manual, please contact your local GP distributor.

Also, If you have any question about your personal computer or Windows, please contact your PC distributor or manufacturer.







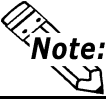

## ■ Safety Symbols and Terms

This manual uses the following symbols and terms to identify important information related to the correct and safe operation of this product.

Symbol	Description
	Indicates a potentially hazardous situation that could result in serious injury or death.
	Indicates a potentially hazardous situation that could result in minor injury or equipment damage.
	Indicates a potentially damaging action or dangerous situation that could result in abnormal equipment operation or data loss.
	Indicates instructions or procedures that must be performed to ensure correct product use.
	Indicates instructions or procedures that must not be performed.

■ **General Information Symbols and Terms**









This manual uses the following symbols and terms for general information.

Symbol	Description
	Provides hints on correct product use, or supplementary information.
	Indicates an item's related information (manual name, chapter, section, sub-section).
	Refers to keys on the computer keyboard.  ■ <i>Keyboard Compatibility List</i>
<b>IBM Compatible</b>	Indicates a PC that can run the Windows® operating system.
<b>Device</b>	A device connected to the GP, such as a programmable logic controller, sequencer, thermoregulator or inverter.
<b>GP</b>	Generic name for the "GP Series" of programmable operator interface made by the Digital Electronics Corporation. For a list of compatible GP products please see "Compatible Products and Environmental Specifications".  <i>LIST OF SUPPORTED MODELS</i> ■ <i>List of Supported GPs</i>
<b>GLC</b>	Generic name for the GLC Series of Graphic Logic Controllers made by Digital Electronics Corporation.  <i>LIST OF SUPPORTED MODELS</i> ■ <i>List of Supported GLCs</i>
<b>ST</b>	Generic name for the ST Series of Programmable Operator Interfaces by Digital Electronics Corporation.  <i>LIST OF SUPPORTED MODELS</i> ■ <i>List of Supported STs</i>
<b>LT</b>	Generic name for the LT Series of Graphic Logic Controllers by Digital Electronics Corporation.  <i>LIST OF SUPPORTED MODELS</i> ■ <i>List of Supported LTs</i>

## ■ Keyboard Compatibility List

This manual uses the following symbols to indicate computer keyboard keys.

The key names used by your computer keyboard may differ. Please use the chart below for reference.

Type Symbol	PS/2 Compatible 101 Keyboard
	Esc
	Tab 
	Ctrl
	-Shift
	Alt
	Delete
	Backspace

## ■ Typical User Configuration

This manual's description of this software's operating procedures and features is based on the PC system configuration shown below.

If you use a different configuration, the PC and GP screens, as well as the names used for pre-made Parts may differ. In this case, please substitute the equivalent screen and part names of your system for those given in this manual.

Hardware/Software	Specification	Remarks
OS	Windows 98	
Device	Mitsubishi MELSEC AnA series (Link)	
GP	GP-2600T	
Connection between the GP and PC	RS-232C	<u>Recommended Cable:</u> GPW-CB02 Made by Digital Electronics Corporation

# PRECAUTIONS

## ■ CD-ROM Usage Precautions

To prevent CD-ROM damage or malfunctions, please observe the following instructions:



- Do not remove the CD-ROM from the CD-ROM drive while the drive's operation lamp is lit.
- Do not touch the CD-ROM recording surface.
- Do not place CD-ROMs in a place where they may be exposed to extremely high or low temperatures, high humidity, or dust.

## ■ Product Usage Precautions

To prevent program malfunction or accidents, be sure to observe the following instructions:



- **Touch panel switches should NOT be used for a device's Emergency Stop Switch. Minister of Health, Labour and Welfare speaking, all industrial machinery/systems must be equipped with a mechanical, manually operated emergency stop switch. Also, for other kinds of systems, similar mechanical switches must be provided to ensure safe operation of those systems.**



- Do not turn off your personal computer's power switch during the execution of a program.
- After you create a screen with this product and transfer it to the GP unit, do not send the same screen from the GP to a DOS version of this screen editor software (e.g. GP-PRO/PB III, GP-PRO III).
- Do not change the contents of this product's project files using the Text Editor software.
- Do not send a screen to a GP unit if that GP does not support the functions provided by your screen editor software.

# GENERAL GP RESTRICTIONS

## ◆ Drawing

- The GP-PRO/PB III for Windows software displays screen data using your personal computer's fonts and graphic functions. Therefore, there may be a slight difference between the data displayed on your personal computer and the data displayed on the GP unit after that screen data is sent to the GP.
- When characters are positioned on a tiling pattern, they may not be displayed properly on the GP unit if the dot pattern of the characters matches that of the tiling pattern and the characters are positioned on the same color. To solve the problem, shift the characters by one dot.
- When a GP unit is vertically installed, the panel's coordinates will differ from those used on the screen editor software. Therefore, when you enter screen coordinates using tags or D-Script, please consider the GP's orientation.

**(0. 0) on the screen editor software**

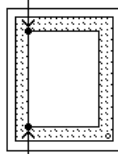

**(0. 0) on the GP series' panel**

- If you change the orientation of a GP unit between "horizontal type" and "vertical type", the drawing screen will rotate in response to "horizontal type" and "vertical type". Objects with even dots that are already placed on the drawing screen may be shifted by one dot from the original position. After you change the orientation of a GP unit between "horizontal type" and "vertical type", please check whether any objects are shifted or not on the screen editor. If any, edit and replace them properly.
- Double-byte characters used in a project (including filenames and titles) may not display correctly when displayed in a single-byte drawing environment. If you intend to use your screen data in a single-byte environment, be sure to use only single-byte characters for screen text.
- Data should be edited using the same environment (OS) it was created with. If a different OS is used, characters may change or be unreadable.

## ◆ Functions and Settings

- Certain functions and setting supported by the GP unit are not supported by the GP-PRO/PB III for Windows program, and vice versa.

**[Setting and functions items set via the GP unit (Not by GP-PRO/PB III for Windows) ]**

- Language Font selection
- GP Date/Time
- GP Self-Diagnosis Function
- Functions for adjusting the Video Display

**[Functions and setting items supported by GP-PRO/PB III for Windows only (Not by the GP unit)]**

The following settings are included in the "GP System Settings" area:

- "Checksum Verification"
- "Buzzer Output"
- Screen Change Order in hierarchical display mode
- Turning the "Common Password" On/Off
- Screen Change according to standby mode time
- Shift to OFFLINE mode
- "K-tag" processing
- GP unit's internal memory (LS area) backup function
- "Error Display Reset"
- "Watchdog" (Monitoring the communication status between the GP and the device)

## GENERAL GP RESTRICTIONS

- Address setting for "CF Card Control Setting" (Data Storage/Space Storage Address/SRAM Auto Backup)
  - "Q-tag" settings (Display format, Print Settings, and Alarm Trigger Count Write's Start Address/Processing Performed at GP power-ON/Perform External Operations/Q-tag: Time Character addition (format))
  - Communication Monitoring Period settings (Designate transmission wait time)
  - Data Backup
  - Display Colors
  - FEP Setting
  - Serial code reader (LS storage start address/Read complete bit address/Data storage setting)
  - The Control Word Address setting for the "Screen Capture" function
  - "Print Type" (Setting the print function with the tool connector)  
This feature is only available with GLC2300 Series units.
  - The following GP-PRO/PB III for Windows features, even though they can be set using the GP-PRO/PBIII software, are currently not supported for the following PLCs. **▼Reference▲ Tag Reference Manual**  
Be sure to check that your type of PLC supports the features you wish to use on the GP prior to creating your GP-PRO/PBIII for Windows project data.
  - Adjustment of Touch Panel Scan Sensitivity
- When a device/PLC shown in the table below is connected, some GP settings and software features may be limited.  
Before creating new screens, see the table below.

**▼Reference▲ Device/PLC Connection Manual**

### <Functions of GP-PRO/PB III for Windows Ver. 7.0>

○ : Supported ● : Depends on the unit X: Not supported:

Specified in:	Item	Rockwell (Allen-Bradley)			Modicon	
		SLC500/PLC-5 DataHighway+	PLC-5 Remote I/O	SLC500 DH485	Modbus Slave	Modbus Plus
GP	Communication setting	X <sup>*1</sup>	X <sup>*1</sup>	X <sup>*1</sup>	○	X <sup>*1</sup>
	Operating environment	X <sup>*1</sup>	X <sup>*1</sup>	● <sup>*2</sup>	○	X <sup>*1</sup>
Software	Use System Area	○	X	○	○	○
	Use Read Area	○	X	○	○	○
	E-tag, K-tag: Indirect setting	X	X	X	○	X
	H-tag: Read after startup	X	X	○	○	X
	S-tag: Read after startup	X	X	○	○	X
	Trend graph "block display"	X <sup>*4</sup>	X	○	○	X <sup>*4</sup>
	D-script: Memory Copy	X	X	○	○	X
	D-script: Address Offset Designation	X	X	○	○	X
	Filing data function	X	X	○	○	X
	CSV data transfer function	X	X	○	○	X
	Logging function	X	X	○	○	X
	GP resetting due to write error	X	X	○	X	X
	Data backup	X	X	○	○	X
2-Way driver	● <sup>*3</sup>	● <sup>*3</sup>	● <sup>*3</sup>	○	● <sup>*3</sup>	

\*1 These items can be set using [GP Setup] of GP-PRO/PB III for Windows.

\*2 "maximum id" can be set using [GP Setup] of GP-PRO/PB III for Windows.

\*3 Only the LS area can be used.

\*4 Displays support available when Device/PLC Device Addresses are used. Use of the GP LS Area's Read Area is supported ("○").

## &lt;Functions of GP-PRO/PB III for Windows Ver. 6.3&gt;

O : Supported ● : Depends on the unit X: Not supported

**GP 70 Series**

Items	GP-H70 GP-370 GP-57JS	GP-270	GP-470	GP-570	GP-571	GP-675	GP-570VM	GP-870VM	GP-377L	GP-377S	GP-37W2B
Full color (64-color) display	X	X	X	X	O	O	X	X	X	O	X
3-speed blinking	X	X	X	X	O	O	X	X	X	O	X
Data sampling	O	X	O	O	O	O	O	O	O	O	O
LS area backup	X	X	●	●	O	O	X	X	O	O	O
Trend graph (tag) backup	X	X	●	●	O	O	X	X	O	O	O
Trend graph (tag) "block display"	O	X	O	O	O	O	O	O	O	O	O
Trend graph (tag) lower-section fill	O	X	O	O	O	O	O	O	O	O	O
Changing color using K-tag bit	O	X	O	O	O	O	O	O	O	O	O
E-tag, g-tag, K-tag: Indirect color setting	O	X	O	O	O	O	O	O	O	O	O
E-tag, g-tags: Indirect designation of relative value range	O	X	O	O	O	O	O	O	O	O	O
C-tag, E-tag, S-tag: Tiling background colors (Bg)	O	X	O	O	O	O	O	O	O	O	O
g-tag: Color differentiation in graph display	O	X	O	O	O	O	O	O	O	O	O
D-script Additions (Drawing, Math Functions)	O	X	O	O	O	O	O	O	O	O	O
Drawing function (H-tag)	O	X	O	O	O	O	O	O	O	O	O
T-tag: Radio switch function	O	X	O	O	O	O	O	O	O	O	O
Inching output switch (Tih-tag and Tiw-tag)	X	X	O	O	O	O	O	O	X	X	X
Q-tag: Backup	X	X	●	●	O	O	X	X	O	O	O
Q-tag: Setting display format	O	X	O	O	O	O	O	O	O	O	O
Q-tag: Display by second	O	X	O	O	O	O	O	O	O	O	O
Q-tag: Setting print color	X	X	X	O	O	O	O	O	X	X	X
Tank graph (pre-made parts)	O	X	O	O	O	O	O	O	O	O	O
Meter graph (pre-made parts)	O	X	O	O	O	O	O	O	O	O	O
Video window display (V-tag)	X	X	X	X	X	X	O	O	X	X	X
Setting Direction of Screen Printout	X	X	X	X	X	O	X	X	X	X	X
Interrupt/cancel hard- copy printout	X	X	O	O	O	O	O	O	X	X	X
Set "OFFLINE" mode switch feature off	O	O	O	O	O	O	O	X	O	O	O
Q-tag: Sub-display	O	X	O	O	O	O	O	O	O	O	O

<Functions of GP-PRO/PB III for Windows Ver. 6.3>

○ : Supported ● : Depends on the unit X: Not supported

**GP 70 Series**

Items	GP-H70 GP-370 GP-57JS	GP-270	GP-470	GP-570	GP-571	GP-675	GP-570VM	GP-870VM	GP-377L	GP-377S	GP-37W2B
Q-tag: Grouping of alarms into a block	X	X	X	X	X	X	X	X	○	○	○
A-tag: Indirect designation of text screen or sub-display screen	X	X	X	X	X	X	X	X	○	○	○
Filing data function	X	X	X	X	X	X	X	X	○	○	○
Data logging function	X	X	X	X	X	X	X	X	○	○	○
Sound output function	X	X	X	X	X	X	X	X	X	X	X
CF Card compatibility	X	X	X	X	X	X	X	X	X	X	X
Global D-script	X	X	X	X	X	X	X	X	○	○	○
Compatible with Pro-Server	X	X	X	X	X	X	X	X	X	X	X
Compatible with LS area for simulation	X	X	X	X	X	X	X	X	○	○	○
GP resetting due to write error	X	X	X	X	X	X	X	X	○	○	○
Compatible with transfer speed of 115.2Kbps	X	X	X	X	X	X	X	X	○	○	○
Creation of composite parts for Filing Data	X	X	X	X	X	X	X	X	○	○	○
D-script: Bit dual state trigger	X	X	X	X	X	X	X	X	○	○	○
D-script: Memory Copy	X	X	X	X	X	X	X	X	○	○	○
D-script: Memory block initialization	X	X	X	X	X	X	X	X	○	○	○
D-script: Loop function	X	X	X	X	X	X	X	X	○	○	○
D-script: Address offset designation	X	X	X	X	X	X	X	X	○	○	○
D-script: Temporary address (can be used up to 90 addresses)	X	X	X	X	X	X	X	X	○	○	○
Filing function: Can be designated up to 10,000 pieces of data	X	X	X	X	X	X	X	X	○	○	○
Filing function: Multiple folders	X	X	X	X	X	X	X	X	○	○	○
Filing function: Stores the cursor position.	X	X	X	X	X	X	X	X	○	○	○
Filing function: PLC data transfer completion Bit Address	X	X	X	X	X	X	X	X	○	○	○
Logging function: Loop function	X	X	X	X	X	X	X	X	○	○	○
Logging function: Total LS data write	X	X	X	X	X	X	X	X	○	○	○
CF Card free capacity storage	X	X	X	X	X	X	X	X	X	X	X



## &lt;Functions of GP-PRO/PB III for Windows Ver. 6.3&gt;

O : Supported ● : Depends on the unit X: Not supported

**GP 70 Series**

Items	GP-H70 GP-370 GP-57JS	GP- 270	GP- 470	GP- 570	GP- 571	GP- 675	GP- 570VM	GP- 870VM	GP- 377L	GP- 377S	GP 37W2B
4-state lamp (pre-made parts)	X	X	X	X	X	X	X	X	O	O	O
T-tag: Grouping with auto OFF	X	X	X	X	X	X	X	X	O	O	O
T-tag: Interlock Touch Available Conditions (bit OFF)	X	X	X	X	X	X	X	X	O	O	O
Offline shift (pre-made parts)	X	X	X	X	X	X	X	X	O	O	O
Q-tag block printing	X	X	X	X	X	X	X	X	X	X	X
Q-tag external operation	X	X	X	X	X	X	X	X	O	O	O
A-tag blank line display	X	X	X	X	X	X	X	X	O	O	O
Alarm message: Can be used up to 512 messages	X	X	X	X	X	X	X	X	O	O	O
Backlight burnout detector	X	X	X	X	X	X	X	X	O	O	X
Internal 2-Port function	X	X	X	X	X	X	X	X	O	O	O
GB-WEB compatibility	X	X	X	X	X	X	X	X	X	X	X
PLC Simulation via Ethernet	X	X	X	X	X	X	X	X	X	X	X
Factory-Set IP address settings for data transfer	X	X	X	X	X	X	X	X	X	X	X
General SIO Protocol	X	X	X	X	X	X	X	X	X	X	X
Serial 2-D reader compatibility	X	X	X	X	X	X	X	X	X	X	X
Serial bar-code reader compatibility	X	X	X	X	X	X	X	X	X	X	X
256-color display	X	X	X	X	X	X	X	X	X	X	X
Q-tag: up to 2048 messages	X	X	X	X	X	X	X	X	X	X	X
Q-tag: Expansion of time format digits	X	X	X	X	X	X	X	X	O	O	O
T-tag: momentary (one-shot buzzer)	X	X	X	X	X	X	X	X	O	O	O
Number of logging words: 255	X	X	X	X	X	X	X	X	X	X	X
Image Fonts	X	X	X	X	X	X	X	X	X	X	X
Multi Language Display Function	X	X	X	X	X	X	X	X	O	O	O
Screen Snapshot Function for Simulation	X	X	X	X	X	X	X	X	X	X	X
I/O Setting (Monitor function for touch panel input time)	X	X	X	X	X	X	X	X	X	X	X
Image Parts	X	X	X	X	X	X	X	X	X	X	X
Screen Capture Function	X	X	X	X	X	X	X	X	X	X	X
Compatible with v-tag	X	X	X	X	X	X	X	X	X	X	X
Pop-up Keyboard Function	X	X	X	X	X	X	X	X	O	O	O
Global Vibration Function	X	X	X	X	X	X	X	X	X	X	X

<New Functions of GP-PRO/PB III for Windows Ver. 6.3>

O : Supported ● : Depends on the unit X: Not supported

**GP70 Series**

Items	GP-H70 GP-370 GP-57JS	GP-270	GP-470	GP-570	GP-571	GP-675	GP-570VM	GP-870VM	GP-377L	GP-377S	GP-37W2 B
CSV Data Transfer Function	x	x	x	x	x	x	x	x	x	x	x
CSV File Display Function	x	x	x	x	x	x	x	x	x	x	x
CF Card File Manager Function	x	x	x	x	x	x	x	x	x	x	x
Extended SIO Script	x	x	x	x	x	x	x	x	x	x	x
Trend Graph: Data Record Display	x	x	x	x	x	x	x	x	x	x	x
Trend Graph/Data Sampling: Up to 40 trend lines	x	x	x	x	x	x	x	x	x	x	x
Backup Function for Trend Graph parts	x	x	x	x	x	x	x	x	x	x	x
Q-tag Log Alarm: Date display for all alarms	x	x	x	x	x	x	x	x	x	x	x
SRAM Auto Backup Function	x	x	x	x	x	x	x	x	x	x	x
Filing Function: Block No./Block Name Transfer	x	x	x	x	x	x	x	x	x	x	x
Text Size: Added Control for size adjustments (integers from 1 to 8)	x	x	x	x	x	x	x	x	x	x	x
Loop Function with Screen Capture	x	x	x	x	x	x	x	x	x	x	x
Screen Capture Completed Bit Setting	x	x	x	x	x	x	x	x	x	x	x
On/Off of Common Password for Offline mode	x	x	x	x	x	x	x	x	x	x	x
GLC Ladder Monitor Function <sup>*1</sup>	x	x	x	x	x	x	x	x	x	x	x
Support for Index Text in Message Display	x	x	x	x	x	x	x	x	O	O	O

\*1 Supported only by GLC-2400/2500/2600 Series units.

## &lt;New Functions of GP-PRO/PB III for Windows Ver. 6.3&gt;

O : Supported ● : Depends on the unit X: Not supported

**GP70 Series**

Items	GP-H70 GP-370 GP-57JS	GP-270	GP-470	GP-570	GP-571	GP-675	GP-570 VM	GP-870 VM	GP-377L	GP-377S	GP-37W 2B
8-level monochrome display	X	X	X	X	X	X	X	X	X	X	X
Trend graph (Block Display) Dot display	X	X	X	X	X	X	X	X	X	X	X
Trend graph (Block Display) Assistant line display	X	X	X	X	X	X	X	X	X	X	X
Trend graph (Block Display) Display range designation	X	X	X	X	X	X	X	X	X	X	X
CSV data transfer: Condition name search/auto-transfer	X	X	X	X	X	X	X	X	X	X	X
D-Script CF file operation function	X	X	X	X	X	X	X	X	X	X	X
D-Script Printer port operation function	X	X	X	X	X	X	X	X	X	X	X
Serial interface selection	X	X	X	X	X	X	X	X	X	X	X
Background color for G-tags and bar/pie/half pie graph parts	X	X	X	X	X	X	X	X	X	O	O
CF Memory Loader Tool: Conversion from MEM file to PRW file	X	X	X	X	X	X	X	X	X	X	X
CF Memory Loader Tool: Multiple projects	X	X	X	X	X	X	X	X	X	X	X
7-segment display of parts	X	X	X	X	X	X	X	X	X	X	X
Multiple Copies -Copy Direction Selection	O	O	O	O	O	O	O	O	O	O	O
Index Text Center Positioning	X	X	X	X	X	X	X	X	O	O	O
Extended Font Char. Size	O	O	O	O	O	O	O	O	O	O	O
Security Levels	X	X	X	X	X	X	X	X	X	X	X
Time Schedule	X	X	X	X	X	X	X	X	X	X	X
OFFLINE Language Switching	X	X	X	X	X	X	X	X	X	X	X
Half-2 Byte Character	O	X	O	O	O	O	O	O	O	O	O

<Functions of GP-PRO/PB III for Windows Ver. 6.3>

○ : Supported ● : Depends on the unit X: Not supported

**GP77R/GP2000 Series**

Items	GP-377R	GP-477R	GP-577R	GP-2301H	GP-2401H	GP-2300	GP-2301	GP-2400	GP-2401	GP-2500	GP-2501	GP-2600	GP-2601
Full support (64-color) display	○	X	○	●	○	●*1	●*1	○	○	●*1	●*1	○	○
3-speed blinking	○	X	○	●	○	●*1	●*1	○	○	●*1	●*1	○	○
Data sampling	○	○	○	○	○	○	○	○	○	○	○	○	○
LS area backup	○	○	○	○	○	○	○	○	○	○	○	○	○
Trend graph (tag) backup	○	○	○	○	○	○	○	○	○	○	○	○	○
Trend graph (tag) "block display"	○	○	○	○	○	○	○	○	○	○	○	○	○
Trend graph (tag) lower-section fill	○	○	○	○	○	○	○	○	○	○	○	○	○
Changing color using K-tag bit	○	○	○	○	○	○	○	○	○	○	○	○	○
E-tag, g-tag, K-tag: Indirect color setting	○	○	○	○	○	○	○	○	○	○	○	○	○
E-tag, g-tags: Indirect designation of relative value range	○	○	○	○	○	○	○	○	○	○	○	○	○
C-tag, E-tag, S-tag: Tiling background colors (Bg)	○	○	○	○	○	○	○	○	○	○	○	○	○
g-tag: Color differentiation in graph display	○	○	○	○	○	○	○	○	○	○	○	○	○
D-script Additions (Drawing, Math Functions)	○	○	○	○	○	○	○	○	○	○	○	○	○
Drawing function (H-tag)	○	○	○	○	○	○	○	○	○	○	○	○	○
T-tag: Radio switch function	○	○	○	○	○	○	○	○	○	○	○	○	○
Inching output switch (Tih-tag and Tiw-tag)	X	○	○	X	X	X	X	X	X	X	X	X	X
Q-tag: Backup	○	○	○	○	○	○	○	○	○	○	○	○	○
Q-tag: Setting display format	○	○	○	○	○	○	○	○	○	○	○	○	○

\*1 GP-2300L, GP-2301L, GP-2500L and GP-2501L units do not support this feature.

## &lt;Functions of GP-PRO/PB III for Windows Ver. 6.3&gt;

O : Supported ●: Depends on the unit X: Not supported

**GP77R/GP2000 Series**

Items	GP-377R	GP-477R	GP-577R	GP-2301H	GP-2401H	GP-2300	GP-2301	GP-2400	GP-2401	GP-2500	GP-2501	GP-2600	GP-2601
Q-tag: Display by second	O	O	O	O	O	O	O	O	O	O	O	O	O
Q-tag: Setting print color	O	X	O	X	X	●	X	O	O	O	O	O	O
Tank graph (pre-made parts)	O	O	O	O	O	O	O	O	O	O	O	O	O
Meter graph (pre-made parts)	O	O	O	O	O	O	O	O	O	O	O	O	O
Video window display (V-tag)	X	X	X	X	X	X	X	X	X	O <sup>*4</sup>	X	O <sup>*4</sup>	X
Setting Direction of Screen Printout	X	X	X	X	X	X	X	X	O	X	X	O	O
Interrupt/cancel hard-copy printout	O <sup>*2</sup>	O	O	X	X	O	X	O	O	O	O	O	O
Set "OFFLINE" mode switch feature off	O	O	O	O	O	O	O	O	O	O	O	O	O
Q-tag: Sub-display	O	O	O	O	O	O	O	O	O	O	O	O	O
Q-tag: Grouping of alarms into a block	O	O	O	O	O	O	O	O	O	O	O	O	O
A-tag: Indirect designation of text screen or sub-display screen	O	O	O	O	O	O	O	O	O	O	O	O	O
Filing data function	O	O	O	O	O	O	O	O	O	O	O	O	O
Data logging function	O	O	O	O	O	O	O	O	O	O	O	O	O
Sound output function	X	O <sup>*1</sup>	O <sup>*1</sup>	X	X	X	X	O	X	O	O <sup>*5</sup>	O	O <sup>*5</sup>
CF Card compatibility	O <sup>*2</sup>	O <sup>*1</sup>	O <sup>*1</sup>	O	O	O	O	O	O	O	O	O	O
Global D-script	O	O	O	O	O	O	O	O	O	O	O	O	O
Compatible with Pro-Server	O <sup>*2</sup>	O <sup>*3</sup>	O <sup>*3</sup>	X	X	O	X	O	X	O	O <sup>*3</sup>	O	O <sup>*3</sup>
Compatible with LS area for simulation	O	O	O	O	O	O	O	O	O	O	O	O	O
GP resetting due to write error	O	O	O	O	O	O	O	O	O	O	O	O	O
Compatible with transfer speed of 115.2Kbps	O	O	O	O	O	O	O	O	O	O	O	O	O
Creation of composite parts for Filing Data	O	O	O	O	O	O	O	O	O	O	O	O	O

\*1 A large-size multi-unit E is necessary to enable this function.

\*2 A middle-size multi-unit E is necessary to enable this function.

\*3 A large-size multi-unit E or GP Ethernet I/F unit is necessary to enable this function.

\*4 To utilize this feature, the optional VM unit is required.

\*5 A bus conversion unit and a sound output unit (a large-size multi-unit S or a large-size multi-unit E) are required to use this function.

<Functions of GP-PRO/PB III for Windows Ver. 6.3>

O : Supported ● : Depends on the unit X: Not supported

**GP77R/GP2000 Series**

Items	GP - 377R	GP- 477R	GP- 577R	GP- 2301 H	GP- 2401 H	GP- 2300	GP- 2301	GP- 2400	GP- 2401	GP- 2500	GP- 2501	GP- 2600	GP- 2601
D-Script: Bit dual state trigger	0	0	0	0	0	0	0	0	0	0	0	0	0
D-Script: Memory Copy	0	0	0	0	0	0	0	0	0	0	0	0	0
D-Script: Memory block initialization	0	0	0	0	0	0	0	0	0	0	0	0	0
D-Script: Loop function	0	0	0	0	0	0	0	0	0	0	0	0	0
D-Script: Address offset designation	0	0	0	0	0	0	0	0	0	0	0	0	0
D-Script: Temporary address (can be used up to 90 addresses)	0	0	0	0	0	0	0	0	0	0	0	0	0
Filing function: Can be designated up to 10,000 pieces of data	0	0	0	0	0	0	0	0	0	0	0	0	0
Filing function: Multiple folders	0	0	0	0	0	0	0	0	0	0	0	0	0
Filing function: Stores the cursor position.	0	0	0	0	0	0	0	0	0	0	0	0	0
Filing function: Device data transfer completion Bit Address	0	0	0	0	0	0	0	0	0	0	0	0	0
Logging function: Loop function	0	0	0	0	0	0	0	0	0	0	0	0	0
Logging function: Total LS data write	0	0	0	0	0	0	0	0	0	0	0	0	0
CF Card free capacity storage	0 <sup>*2</sup>	0 <sup>*1</sup>	0 <sup>*1</sup>	0	0	0	0	0	0	0	0	0	0
4-state lamp (pre-made parts)	0	0	0	0	0	0	0	0	0	0	0	0	0
T-tag: Grouping with auto OFF	0	0	0	0	0	0	0	0	0	0	0	0	0
T-tag: Interlock Touch Available Conditions (bit OFF)	0	0	0	0	0	0	0	0	0	0	0	0	0
Offline shift (pre-made parts)	0	0	0	0	0	0	0	0	0	0	0	0	0
Q-tag block printing	0 <sup>*2</sup>	0	0	X	X	0	X	0	0	0	0	0	0
Q-tag external operation	0	0	0	0	0	0	0	0	0	0	0	0	0
A-tag blank line display	0	0	0	0	0	0	0	0	0	0	0	0	0
Alarm message: Can be used up to 512 messages	0	0	0	0	0	0	0	0	0	0	0	0	0
Backlight burnout detector	0	X	X	0	0	0	0	0	0	0	0	0	0
Internal 2-Port function	0	0	0	0	0	0	0	0	0	0	0	0	0

\*1 A large-size multi-unit E is necessary to enable this function.

\*2 A middle-size multi-unit E is necessary to enable this function.

## &lt;Functions of GP-PRO/PB III for Windows Ver. 6.3&gt;

O : Supported ●: Depends on the unit X: Not supported

**GP77R/GP2000 Series**

Items	GP - 377R	GP- 477R	GP- 577R	GP- 2301 H	GP- 2401 H	GP- 2300	GP- 2301	GP - 2400	GP - 2401	GP- 2500	GP- 2501	GP- 2600	GP- 2601
GB-WEB compatibility	O <sup>*1</sup>	O <sup>*2</sup>	O <sup>*2</sup>	X	X	O	X	O	X	O	O <sup>*4</sup>	O	O <sup>*4</sup>
PLC Simulation via Ethernet	X	X	X	X	X	O	X	O	X	O	O <sup>*4</sup>	O	O <sup>*4</sup>
Factory-Set IP address settings for data transfer	X	X	X	X	X	O	X	O	X	O	X	O	X
General SIO Protocol	X	X	X	X	X	O	X	O	X	O	X	O	X
Serial 2-D reader compatibility	X	X	X	X	X	O	X	O	X	O	X	O	X
Serial bar-code reader compatibility	X	X	X	X	X	O	X	O	X	O	X	O	X
256-color display	X	X	X	X	O	● <sup>*5</sup>	● <sup>*5</sup>	O	O	● <sup>*5</sup>	● <sup>*5</sup>	O	O
Q-tag: up to 2048 messages	X	X	X	O	O	O	O	O	O	O	O	O	O
Q-tag: Expansion of time format digits	O	O	O	O	O	O	O	O	O	O	O	O	O
T-tag: momentary (one-shot buzzer)	O	O	O	O	O	O	O	O	O	O	O	O	O
Number of logging words: 255	X	X	X	O	O	O	O	O	O	O	O	O	O
Image Fonts	X	X	X	O	O	O	O	O	O	O	O	O	O
Multi Language Display Function	O	O	O	O	O	O	O	O	O	O	O	O	O
Screen Snapshot Function for Simulation	X	X	X	O	O	O	O	O	O	O	O	O	O
I/O Setting (Monitor function for touch panel input time)	O	O	O	O	O	O	O	O	O	O	O	O	O
Image Parts	X	X	X	O	O	O	O	O	O	O	O	O	O
Screen Capture Function	X	X	X	O	O	O	O	O	O	O	O	O	O
Compatible with v-tag	X	X	X	X	X	X	X	X	X	O <sup>*3</sup>	X	O <sup>*3</sup>	X
Pop-up Keyboard Function	O	O	O	O	O	O	O	O	O	O	O	O	O
Global Vibration Function	X	X	X	O	O	X	X	X	X	X	X	X	X

\*1 A middle-size multi-unit E is necessary to enable this function.

\*2 A large-size multi-unit E or GP Ethernet I/F unit is necessary to enable this function.

\*3 To utilize this feature, the optional VM unit is required.

\*4 A bus conversion unit and a large-size multi-unit E or a GP Ethernet Interface unit are required to enable this function.

\*5 GP-2300L/S, GP-2301L/S, GP-2500L/S and GP-2501L/S do not support this feature.

<New Functions of GP-PRO/PB III for Windows Ver. 6.3>

O : Supported ● : Depends on the unit X: Not supported

**GP77R/GP2000 Series**

Items	GP-377R	GP-477R	GP-577R	GP-2301 H	GP-2401 H	GP-2300	GP-2301	GP-2400	GP-2401	GP-2500	GP-2501	GP-2600	GP-2601
CSV Data Transfer Function	x	x	x	O	O	O	O	O	O	O	O	O	O
CSV File Display Function	x	x	x	O	O	O	O	O	O	O	O	O	O
CF Card File Manager Function	x	x	x	O	O	O	O	O	O	O	O	O	O
Extended SIO Script	x	x	x	O <sup>*2</sup>	O <sup>*2</sup>	O	O <sup>*2</sup>	O <sup>*3</sup>	O <sup>*2</sup>	O <sup>*3</sup>	O <sup>*2*3</sup>	O <sup>*3</sup>	O <sup>*2</sup>
Trend Graph: Data Record Display	x	x	x	O	O	O	O	O	O	O	O	O	O
Trend Graph/Data Sampling: Up to 40 trend lines	x	x	x	O	O	O	O	O	O	O	O	O	O
Backup Function for Trend Graph parts	x	x	x	O	O	O	O	O	O	O	O	O	O
Q-tag Log Alarm: Date display for all alarms	x	x	x	O	O	O	O	O	O	O	O	O	O
SRAM Auto Backup Function	x	x	x	O	O	O	O	O	O	O	O	O	O
Filing Function: Block No./Block Name Transfer	x	x	x	O	O	O	O	O	O	O	O	O	O
Text Size: Extended options for text size (integers from 1 to 8)	x	x	x	O	O	O	O	O	O	O	O	O	O
Loop Function with Screen Capture	x	x	x	O	O	O	O	O	O	O	O	O	O
Screen Capture Completed Bit Setting	x	x	x	O	O	O	O	O	O	O	O	O	O
On/Off of Common Password for Offline mode	x	x	x	O	O	O	O	O	O	O	O	O	O
GLC Ladder Monitor Function <sup>*1</sup>	x	x	x	x	x	x	x	x	x	x	x	x	x
Support for Index Text in Message Display	O	O	O	O	O	O	O	O	O	O	O	O	O

\*1 Supported only by GLC-2400/2500/2600 Series units.

\*2 To enable this function, first install GP-PRO/PBIII version 6.2 or later to enable the serial interface selection feature.

\*3 Depending on the GP revision, it may sometimes not be possible to change the “Serial I/F Switch” setting to “Yes”. For details regarding GP revisions,

**Reference** 4.2.8 Changing Extended SIO Type



## &lt;New Functions of GP-PRO/PB III for Windows Ver. 6.3&gt;

O : Supported ● : Depends on the unit X: Not supported

## GP77R/GP2000 Series

Items	GP-377R	GP-477R	GP-577R	GP-2301 H	GP-2401 H	GP-2300	GP-2301	GP-2400	GP-2401	GP-2500	GP-2501	GP-2600	GP-2601
8-level monochrome display	X	X	X	●	X	●	●	X	X	●	● <sup>*3</sup>	X	X
Trend graph (Block Display)Dot display	X	X	X	O	O	O	O	O	O	O	O	O	O
Trend graph (Block Display)Assistant line display	X	X	X	O	O	O	O	O	O	O	O	O	O
Trend graph (Block Display)Display range designation	X	X	X	O	O	O	O	O	O	O	O	O	O
CSV data transfer: Condition name search/auto-transfer	X	X	X	O	O	O	O	O	O	O	O	O	O
D-Script CF file operation function	X	X	X	O <sup>*2</sup>	O <sup>*2</sup>	O	O <sup>*2</sup>	O	O <sup>*2</sup>	O	O <sup>*2</sup>	O	O <sup>*2</sup>
D-Script Printer port operation function	X	X	X	X	X	O	X	O	O	O	O	O	O
Serial interface selection	X	X	X	O	O	O	O	O <sup>*1</sup>	O	O <sup>*1</sup>	O <sup>*1</sup>	O <sup>*1</sup>	O
Background color for G-tags and bar/pie/half pie graph parts	O	O	O	O	O	O	O	O	O	O	O	O	O
CF Memory Loader Tool: Conversion from MEM file to PRW file	X	X	X	O	O	O	O	O	O	O	O	O	O
CF Memory Loader Tool: Multiple projects	X	X	X	O	O	O	O	O	O	O	O	O	O
7-segment display of parts	X	X	X	O	O	O	O	O	O	O	O	O	O
Multiple Copies -Copy Direction Selection	O	O	O	O	O	O	O	O	O	O	O	O	O
Index Text Center Positioning	O	O	O	O	O	O	O	O	O	O	O	O	O
Extended Font Char. Size	O	O	O	O	O	O	O	O	O	O	O	O	O
Security Levels	X	X	X	X	X	X	X	X	X	X	X	X	X
Time Schedule	X	X	X	X	X	X	X	X	X	X	X	X	X
OFFLINE Language Switching	X	X	X	X	X	X	X	X	X	X	X	X	X
Half-2 Byte Character	O	O	O	O	O	O	O	O	O	O	O	O	O

\*1 Depending on the GP revision, it may sometimes not be possible to change the “Serial I/F Switch” setting to “Yes”. For details regarding GP revisions,

**Reference** 4.2.8 Changing Extended SIO Type

\*2 This function can be used for the D-Script or Global D-Script. For the extended SIO Script, the serial interface selection must be designated in advance for the extended SIO Script protocol.

\*3 The GP-2501T and GP-2501S do not support this function.

<Functions of GP-PRO/PB III for Windows Ver. 6.3>

O : Supported ● : Depends on the unit X: Not supported

**ST Series**

Items	ST	Items	ST	Items	ST
Full support (64-color) display	X	A-tag: Indirect designation of text screen or sub-display screen	O	Q-tag block printing	X
3-speed blinking	X	Filing data function	O	Q-tag external operation	O
Data sampling	O	Data logging function	O	A-tag blank line display	O
LS area backup	O	Sound output function	X	Alarm message: Can be used up to 512 messages	O
Trend graph (tag) backup	O	CF Card compatibility	X	Backlight burnout detector	X
Trend graph (tag) "block display"	O	Global D-script	O	Internal 2-Port function	O
Trend graph (tag) lower-section fill	O	Compatible with Pro-Server	●*1	GB-WEB compatibility	●*1
Changing color using K-tag bit	O	Compatible with LS area for simulation	O	PLC Simulation via Ethernet	●*1
E-tag, g-tag, K-tag: Indirect color setting	O	GP resetting due to write error	O	Factory-Set IP address settings for data transfer	●*1
E-tag, g-tags: Indirect designation of relative value range	O	Compatible with transfer speed of 115.2Kbps	O	General SIO Protocol	X
C-tag, E-tag, S-tag: Tiling background colors (Bg)	O	Creation of composite parts for Filing Data	O	Serial 2-D reader compatibility	X
g-tag: Color differentiation in graph display	O	D-Script: Bit dual state trigger	O	Serial bar-code reader compatibility	X
D-script Additions (Drawing, Math Functions)	O	D-Script: Memory Copy	O	256-color display	X
Drawing function (H-tag)	O	D-Script: Memory block initialization	O	Q-tag: up to 2048 messages	O
T-tag: Radio switch function	O	D-Script: Loop function	O	Q-tag: Expansion of time format digits	O
Inching output switch (Tih-tag and Tiw-tag)	x	D-Script: Address offset designation	O	T-tag: momentary (one-shot buzzer)	O
Q-tag: Backup	O	D-Script: Temporary address (can be used up to 90 addresses)	O	Number of logging words: 255	O
Q-tag: Setting display format	O	Filing function: Can be designated up to 10,000 pieces of data	O	Image Fonts	O
Q-tag: Display by second	O	Filing function: Multiple folders	O	Multi Language Display Function	O
Q-tag: Setting print color	x	Filing function: Stores the cursor position.	O	Screen Snapshot Function for Simulation	X
Tank graph (pre-made parts)	O	Filing function: Device data transfer completion Bit Address	O	I/O Setting (Monitor function for touch panel input time)	O
Meter graph (pre-made parts)	O	Logging function: Loop function	O	Image Parts	O
Video window display (V-tag)	X	Logging function: Total LS data write	O	Screen Capture Function	X
Setting Direction of Screen Printout	X	CF Card free capacity storage	X	Compatible with v-tag	X
Interrupt/cancel hard-copy printout	X	4-state lamp (pre-made parts)	O	Pop-up Keyboard Function	O
Set "OFFLINE" mode switch feature off	O	T-tag: Grouping with auto OFF	O	Global Vibration Function	X
Q-tag: Sub-display	O	T-tag: Interlock Touch Available Conditions (bit OFF)	O		
Q-tag: Grouping of alarms into a block	O	Offline shift (pre-made parts)	O		

\*1 Supported only by ST403 units from Ver. 7.2.

## &lt;New Functions of GP-PRO/PB III for Windows Ver. 6.3&gt;

O : Supported ● : Depends on the unit X: Not supported

**ST Series**

Items	ST	Items	ST
CSV Data Transfer Function	x	Trend graph (Block Display) Assistant line display	O
CSV File Display Function	x	Trend graph (Block Display) Display range designation	O
CF Card File Manager Function	x	CSV data transfer: Condition name search/auto- transfer	X
Extended SIO Script	O* <sup>1</sup>	D-Script CF file operation function	X
Trend Graph: Data Record Display	O	D-Script Printer port operation function	X
Trend Graph/Data Sampling: Up to 40 trend lines	O	Serial interface selection	O* <sup>2</sup>
Backup Function for Trend Graph parts	O	Background color for G-tags and bar/pie/half pie graph parts	O
Q-tag Log Alarm: Date display for all alarms	O	CF Memory Loader Tool: Conversion from MEM file to PRW file	X
SRAM Auto Backup Function	x	CF Memory Loader Tool: Multiple projects	X
Filing Function: Block No./Block Name Transfer	O	7-segment display of parts	O
Text Size: Extended options for text size (integers from 1 to 8)	O	Multiple Copies -Copy Direction Selection	O
Loop Function with Screen Capture	x	Index Text Center Positioning	O
Screen Capture Completed Bit Setting	x	Extended Font Char. Size	O
On/Off of Common Password for Offline mode	O	Security Levels	O
GLC Ladder Monitor Function	x	Time Schedule	O
Support for Index Text in Message Display	O	OFFLINE Language Switching	O
8-level monochrome display	O	Half-2 Byte Character	O
Trend graph (Block Display) Dot display	O		

\*1 To enable this function with the ST400/ST401/ST403 units, the serial I/F switching function must be configured in advance.

\*2 Supported by all ST Series units from Ver. 7.2.

<Functions of GP-PRO/PB III for Windows Ver. 6.3>

○ : Supported ● : Depends on the unit X: Not supported

**LT Series**

Items	LT	Items	LT	Items	LT
Full support (64-color) display	● *1	A-tag: Indirect designation of text screen or sub-display screen	○	Q-tag block printing	X
3-speed blinking	● *1	Filing data function	○	Q-tag external operation	○
Data sampling	○	Data logging function	○	A-tag blank line display	○
LS area backup	○	Sound output function	X	Alarm message: Can be used up to 512 messages	○
Trend graph (tag) backup	○	CF Card compatibility	X	Backlight burnout detector	○
Trend graph (tag) "block display"	○	Global D-script	○	Internal 2-Port function	○
Trend graph (tag) lower-section fill	○	Compatible with Pro-Server	X	GB-WEB compatibility	X
Changing color using K-tag bit	○	Compatible with LS area for simulation	● *2	PLC Simulation via Ethernet	X
E-tag, g-tag, K-tag: Indirect color setting	○	GP resetting due to write error	○	Factory-Set IP address settings for data transfer	X
E-tag, g-tags: Indirect designation of relative value range	○	Compatible with transfer speed of 115.2Kbps	○	General SIO Protocol	X
C-tag, E-tag, S-tag: Tiling background colors (Bg)	○	Creation of composite parts for Filing Data	○	Serial 2-D reader compatibility	X
g-tag: Color differentiation in graph display	○	D-Script: Bit dual state trigger	○	Serial bar-code reader compatibility	X
D-script Additions (Drawing, Math Functions)	○	D-Script: Memory Copy	○	256-color display	X
Drawing function (H-tag)	○	D-Script: Memory block initialization	○	Q-tag: up to 2048 messages	○
T-tag: Radio switch function	○	D-Script: Loop function	○	Q-tag: Expansion of time format digits	○
Inching output switch (Tih-tag and Tiw-tag)	X	D-Script: Address offset designation	○	T-tag: momentary (one-shot buzzer)	○
Q-tag: Backup	○	D-Script: Temporary address (can be used up to 90 addresses)	○	Number of logging words: 255	X
Q-tag: Setting display format	○	Filing function: Can be designated up to 10,000 pieces of data	○	Image Fonts	X
Q-tag: Display by second	○	Filing function: Multiple folders	○	Multi Language Display Function	○
Q-tag: Setting print color	X	Filing function: Stores the cursor position.	○	Screen Snapshot Function for Simulation	X
Tank graph (pre-made parts)	○	Filing function: Device data transfer completion Bit Address	○	I/O Setting (Monitor function for touch panel input time)	X
Meter graph (pre-made parts)	○	Logging function: Loop function	○	Image Parts	X
Video window display (V-tag)	X	Logging function: Total LS data write	○	Screen Capture Function	X
Setting Direction of Screen Printout	X	CF Card free capacity storage	X	Compatible with v-tag	X
Interrupt/cancel hard-copy printout	X	4-state lamp (pre-made parts)	○	Pop-up Keyboard Function	○
Set "OFFLINE" mode switch feature off	○	T-tag: Grouping with auto OFF	○	Global Vibration Function	X
Q-tag: Sub-display	○	T-tag: Interlock Touch Available Conditions (bit OFF)	○		
Q-tag: Grouping of alarms into a block	○	Offline shift (pre-made parts)	○		

\*1 Supported only by Color-type LT Series units.

\*2 Supported only by LT Series Type-C units.

## &lt;New Functions of GP-PRO/PB III for Windows Ver. 6.3&gt;

O : Supported ● : Depends on the unit X: Not supported

**LT Series**

Items	LT	Items	LT
CSV Data Transfer Function	x	Trend graph (Block Display)Assistant line display	x
CSV File Display Function	x	Trend graph (Block Display)Display range designation	x
CF Card File Manager Function	x	CSV data transfer: Condition name search/auto-transfer	x
Extended SIO Script	x	D-Script CF file operation function	x
Trend Graph: Data Record Display	x	D-Script Printer port operation function	x
Trend Graph/Data Sampling: Up to 40 trend lines	x	Serial interface selection	x
Backup Function for Trend Graph parts	x	Background color for G-tags and bar/pie/half pie graph parts	○
Q-tag Log Alarm: Date display for all alarms	x	CF Memory Loader Tool: Conversion from MEM file to PRW file	x
SRAM Auto Backup Function	x	CF Memory Loader Tool: Multiple projects	x
Filing Function: Block No./Block Name Transfer	x	7-segment display of parts	x
Text Size: Extended options for text size (integers from 1 to 8)	x	Multiple Copies -Copy Direction Selection	○
Loop Function with Screen Capture	x	Index Text Center Positioning	○
Screen Capture Completed Bit Setting	x	Extended Font Char. Size	○
On/Off of Common Password for Offline mode	x	Security Levels	x
GLC Ladder Monitor Function	○ <sup>*1</sup>	Time Schedule	x
Support for Index Text in Message Display	○	OFFLINE Language Switching	x
8-level monochrome display	x	Half-2 Byte Character	○
Trend graph (Block Display) Dot display	x		

<New Functions of GP-PRO/PB III for Windows Ver. 7.0>

○ : Supported ● : Depends on the unit X : Not supported

**GP70 Series**

Item	GP-H70 GP-370 GP-57JS	GP-270	GP-470	GP-570	GP-571	GP-675	GP-570VM	GP-870VM	GP-377L	GP-377S	GP-37W2B
Q-tag Increased max. no. of blocks to 8.	X	X	X	X	X	X	X	X	X	X	X
Q-tag Alarm event count display	X	X	X	X	X	X	X	X	X	X	X
Q-tag Alarm event accumulated time display	X	X	X	X	X	X	X	X	X	X	X
Q-tag External clear of accumulated Alarm event count/ accumulated time	X	X	X	X	X	X	X	X	X	X	X
Q-tag Alarm message level settings	X	X	X	X	X	X	X	X	X	X	X
Q-tag Alarm message level ID color	X	X	X	X	X	X	X	X	X	X	X
Q-tag Alarm sort	X	X	X	X	X	X	X	X	X	X	X
Q-tag Alarm cursor position/ID alert	X	X	X	X	X	X	X	X	X	X	X
Keypad Input DisplayTouch input (No Popup keypad)	X	X	X	X	X	X	X	X	X	X	X
Keypad Input Display Popup keypad specify arrangement position	X	X	X	X	X	X	X	X	X	X	X
Keypad Input Display Specify entering order and Group No.	X	X	X	X	X	X	X	X	X	X	X
Keypad Input Display Input complete alert bit	X	X	X	X	X	X	X	X	X	X	X
Text screen multi-language display	X	X	X	X	X	X	X	X	X	X	X
Text screen Import/Export	○ <sup>*1</sup>	○ <sup>*1</sup>	○ <sup>*1</sup>	○ <sup>*1</sup>	○ <sup>*1</sup>	○ <sup>*1</sup>	○ <sup>*1</sup>	○ <sup>*1</sup>	○	○	○
Search for IP Address via Ethernet Network	X	X	X	X	X	X	X	X	X	X	X
Set string color background to transparent	○	○	○	○	○	○	○	○	○	○	○
Touch panel scan sensitivity adjustments	○	○	○	○	○	○	○	○	○	○	○
System screen transfer settings	X	X	X	X	X	X	X	X	○	○	○
Selection of the text style for N/E/P/d/S-tags	X	X	X	X	X	X	X	X	X	X	X
L-tag Image Filename Display	X	X	X	X	X	X	X	X	X	X	X
D-Script Memory Operation/CF File Operation Function Additions	X	X	X	X	X	X	X	X	X	X	X

\*1 This feature is valid only for the Import/Export function with the "Do Not Use Table" option enabled.

## &lt;New Functions of GP-PRO/PB III for Windows Ver. 7.0&gt;

O : Supported ● : Depends on the unit X: Not supported

**GP77R/GP2000 Series**

Item	GP-377R	GP-477R	GP-577R	GP-2301H	GP-2401H	GP-2300	GP-2301	GP-2400	GP-2401	GP-2500	GP-2501	GP-2600	GP-2601
Q-tag Increased max. no. of blocks to 8.	x	x	x	0	0	0	0	0	0	0	0	0	0
Q-tag Alarm event count display	x	x	x	0	0	0	0	0	0	0	0	0	0
Q-tag Alarm event accumulated time display	x	x	x	0	0	0	0	0	0	0	0	0	0
Q-tag External clear of accumulated Alarm event count/accumulated time	x	x	x	0	0	0	0	0	0	0	0	0	0
Q-tag Alarm message level settings	x	x	x	0	0	0	0	0	0	0	0	0	0
Q-tag Alarm message level ID color	x	x	x	0	0	0	0	0	0	0	0	0	0
Q-tag Alarm sort	x	x	x	0	0	0	0	0	0	0	0	0	0
Q-tag Alarm cursor position/ID alert	x	x	x	0	0	0	0	0	0	0	0	0	0
Keypad Input DisplayTouch input (No Popup keypad)	x	x	x	0	0	0	0	0	0	0	0	0	0
Keypad Input Display Popup keypad specify arrangement position	x	x	x	0	0	0	0	0	0	0	0	0	0
Keypad Input Display Specify entering order and Group No.	x	x	x	0	0	0	0	0	0	0	0	0	0
Keypad Input Display Input complete alert bit	x	x	x	0	0	0	0	0	0	0	0	0	0
Text screen multi-language display	x	x	x	0	0	0	0	0	0	0	0	0	0
Text screen Import/Export	0	0	0	0	0	0	0	0	0	0	0	0	0
Search for IP Address via Ethernet Network	0 <sup>*1</sup>	0 <sup>*1</sup>	0 <sup>*1</sup>	x	x	0	x	0	x	0	0 <sup>*1</sup>	0	0 <sup>*1</sup>
Set string color background to transparent	0	0	0	0	0	0	0	0	0	0	0	0	0
Touch panel scan sensitivity adjustments	0	0	0	0	0	0	0	0	0	0	0	0	0
System screen transfer settings	0	0	0	0	0	0	0	0	0	0	0	0	0
Selection of the text style for N/E/P/d/S-tags	x	x	x	0	0	0	0	0	0	0	0	0	0
L-tag Image Filename Display	x	x	x	0	0	0	0	0	0	0	0	0	0
D-Script Memory Operation/CF File Operation Function Additions	x	x	x	0	0	0	0	0	0	0	0	0	0

\*1 Use the Pro-Server with Pro-Studio for Windows to register the GP as a participatory node beforehand.

<New Functions of GP-PRO/PB III for Windows Ver. 7.0>

O : Supported ● : Depends on the unit X: Not supported

<b>ST Series</b>	
Item	ST
Q-tag Increased max. no. of blocks to 8.	O
Q-tag Alarm event count display	O
Q-tag Alarm event accumulated time display	O
Q-tag External clear of accumulated Alarm event count/ accumulated time	O
Q-tag Alarm message level settings	O
Q-tag Alarm message level ID color	O
Q-tag Alarm sort	O
Q-tag Alarm cursor position/ID alert	O
Keypad Input Display Touch input (No Popup keypad)	O
Keypad Input Display Popup keypad specify arrangement position	O
Keypad Input Display Specify entering order and Group No.	O
Keypad Input Display Input complete alert bit	O
Text screen multi-language display	O
Text screen Import/Export	O
Search for IP Address via Ethernet Network	● <sup>*1</sup>
Set string color background to transparent	O
Touch panel scan sensitivity adjustments	O
System screen transfer settings	O
Selection of the text style for N/E/P/d/S-tags	O
L-tag Image Filename Display	O
D-Script Memory Operation/CF File Operation Function Additions	O <sup>*2</sup>

\*1 Supported only by ST403 units from Ver. 7.2.

\*2 If the unit used is not equipped with a CF Card interface, the CF File operation feature cannot be used.



## &lt;New Functions of GP-PRO/PB III for Windows Ver. 7.0&gt;

O : Supported ● : Depends on the unit X: Not supported

**LT Series**

Item	LT
Q-tag Increased max. no. of blocks to 8.	X
Q-tag Alarm event count display	X
Q-tag Alarm event accumulated time display	X
Q-tag External clear of accumulated Alarm event count/ accumulated time	X
Q-tag Alarm message level settings	X
Q-tag Alarm message level ID color	X
Q-tag Alarm sort	X
Q-tag Alarm cursor position/ID alert	X
Keypad Input DisplayTouch input (No Popup keypad)	X
Keypad Input Display Popup keypad specify arrangement position	X
Keypad Input Display Specify entering order and Group No.	X
Keypad Input Display Input complete alert bit	X
Text screen multi-language display	X
Text screen Import/Export	O
Search for IP Address via Ethernet Network	X
Set string color background to transparent	O
Touch panel scan sensitivity adjustments	O
System screen transfer settings	O
Selection of the text style for N/E/P/d/S-tags	X
L-tag Image Filename Display	X
D-Script Memory Operation/CF File Operation Function Additions	X

<New Functions of GP-PRO/PB III for Windows Ver. 7.1>

○ : Supported ● : Depends on the unit X: Not supported

**GP70 Series**

Item	GP-H70 GP-370 GP-57JS	GP-270	GP-470	GP-570	GP-571	GP-675	GP-570VM	GP-870VM	GP-377L	GP-377S	GP-37W2B
Keypad Input Display Time-Base Function	X	X	X	X	X	X	X	X	X	X	X
Numeric Display Time-Base Function	X	X	X	X	X	X	X	X	X	X	X
CSV Data Transfer CF Write Mode Function	X	X	X	X	X	X	X	X	X	X	X
Information Data Color Selection	○	○	○	○	○	○	○	○	○	○	○

**GP77R/GP2000 Series**

Item	GP-377R	GP-477R	GP-577R	GP-2301H	GP-2401H	GP-2300	GP-2301	GP-2400	GP-2401	GP-2500	GP-2501	GP-2600	GP-2601
Keypad Input Display Time-Base Function	X	X	X	X	X	○	○	○	○	○	○	○	○
Numeric Display Time-Base Function	X	X	X	X	X	○	○	○	○	○	○	○	○
CSV Data Transfer CF Write Mode Function	X	X	X	○	○	○	○	○	○	○	○	○	○
Information Data Color Selection	○	○	○	○	○	○	○	○	○	○	○	○	○

**ST Series**

Items	ST
Keypad Input Display Time-Base Function	○ <sup>*1</sup>
Numeric Display Time-Base Function	○ <sup>*1</sup>
CSV Data Transfer CF Write Mode Function	X
Information Data Color Selection	○

**LT Series**

Items	LT
Keypad Input Display Time-Base Function	X
Numeric Display Time-Base Function	X
CSV Data Transfer CF Write Mode Function	X
Information Data Color Selection	○

\*1 Supported starting from Ver. 7.2.

<New Functions of GP-PRO/PB III for Windows Ver. 7.2>

O : Supported ● : Depends on the unit X: Not supported

**GP70 Series**

Items	GP-H70 GP-H370 GP-57JS	GP-270	GP-470	GP-570	GP-571	GP-675	GP-570VM	GP-870VM	GP-377L	GP-377S
Global Interlock	x	x	x	x	x	x	x	x	x	x
Backlight Color Change	x	x	x	x	x	x	x	x	x	x
Function: Switch Q-tag Selection Key	○	○	○	○	○	○	○	○	○	○
Duplicate: Equal Layout in Specified Area	○	○	○	○	○	○	○	○	○	○
Centering of Part Label	○	○	○	○	○	○	○	○	○	○

**GP77R/GP2000 Series**

Items	GP-377R	GP-477R	GP-577R	GP-2301H	GP-2401H	GP-2300	GP-2301	GP-2400	GP-2401	GP-2500	GP-2501	GP-2600	GP-2601
Global Interlock	x	x	x	○	○	○	○	○	○	○	○	○	○
Backlight Color Change	x	x	x	x	x	x	x	x	x	x	x	x	x
Function: Switch Q-tag Selection Key	○	○	○	○	○	○	○	○	○	○	○	○	○
Duplicate: Equal Layout in Specified Area	○	○	○	○	○	○	○	○	○	○	○	○	○
Centering of Part Label	○	○	○	○	○	○	○	○	○	○	○	○	○

**ST Series**

Items	ST
Global Interlock	○
Backlight Color Change	●*1
Function: Switch Q-tag Selection Key	○
Duplicate: Equal Layout in Specified Area	○
Centering of Part Label	○

**LT Series**

Items	LT
Global Interlock	×
Backlight Color Change	×
Function: Switch Q-tag Selection Key	○
Duplicate: Equal Layout in Specified Area	○
Centering of Part Label	○

\*1 Supported only by the ST403 units.

# GP SERIES COMPATIBILITY

Files created with prior versions of the software can be converted to GP-PRO/PB III for Windows Ver. 7.2 project files.



- **Ver. 7.2 data cannot be converted to the following data types.**

Original Data Type	Converted Data Type
<b>GP-PRO/PBIII for Windows Ver.7.2 (This product)</b>	GP-PRO
	GP-PROII
	GP-PROIII
	GP-PRO/PBIII (DOS Version)
	GP-PRO/PBIII (Prior to Ver. 7.2)
	Parts Box
	LT Editor

- **Pro-face strongly recommends that you do NOT try to open a project file made using GP-PRO/PBIII for Windows Ver. 7.2 with a prior version of the GP-PRO/PBIII for Windows software. Doing so may delete important setting data.**

## ■ Converting GP-PRO/PB III for Windows File Data

A project file from earlier GP-PRO/PB III for Windows versions can be easily opened with this software.

**Reference** 1.1.2 ■ *Selecting an Existing Project*



- When the following Project files are opened with GP-PRO/PB III for Windows Ver. 7.2, the time stamps of the selected Project files are updated as a result of file data conversion.
- Project files created with GP-PRO/PB III for Windows (Version 6.0 or earlier)  
Once the time stamp has updated, opening the same Project file using version 7.2 will not update the time stamp.
- When the following Project files are opened with GP-PRO/PB III for Windows Ver.7.2 and the [Transfer Settings] dialog box is activated, the time stamps of the selected Project files are updated due to the file data conversion.
- Project files created with GP-PRO/PB III for Windows Ver. 6.3 or earlier  
Once the time stamp is updated, opening the same Project file using version 7.2 will not update the time stamp.

## ■ Converting Data from GP-PRO/PB III (DOS version)

Screen data from GP-PRO/PB III (DOS version) can be opened with the GP-PRO/PB III for Windows Ver. 7.2 software. To do so, specify the "File Type" as a DOS project file (\*.PRO) in the [Files of type:] area, when selecting a project.

**Reference** 1.1.2 ■ *Selecting an Existing Project*

## ■ Converting Data from GP-PRO, GP-PRO II, or GP-PRO/PB III

GP-PRO II or GP-PRO III Screen data can be converted to 7.2 data for use on GP70/GP77R/GP2000 series units using the GP-PRO/PB III for Windows Ver. 7.2 file converter utility. However, after the GP-PRO II or GP-PRO III S0 (System) screen data is converted and sent to a GP70/GP77R/GP2000 series unit, you must then review all GP settings in OFFLINE mode. **Reference** 12.1 File Converter

## ◆ Cautions when converting GP-PRO II Data

If a GP-PRO II screen contains "filled" data, filled tiling patterns may be shifted when displayed on Power GP series (GP70/GP77R/GP2000 series) units. On GP-\*30 and GP-\*50 series units, color is filled on the screen based on the drawing's starting point. However, Power GP series (GP70/GP77R/GP2000 series) units fill color from the upper-left corner (0,0) of the screen, and only show the drawing area. Please be aware of this difference when you call up a filled drawing using L-tags, or when placing filled objects on top of one another.

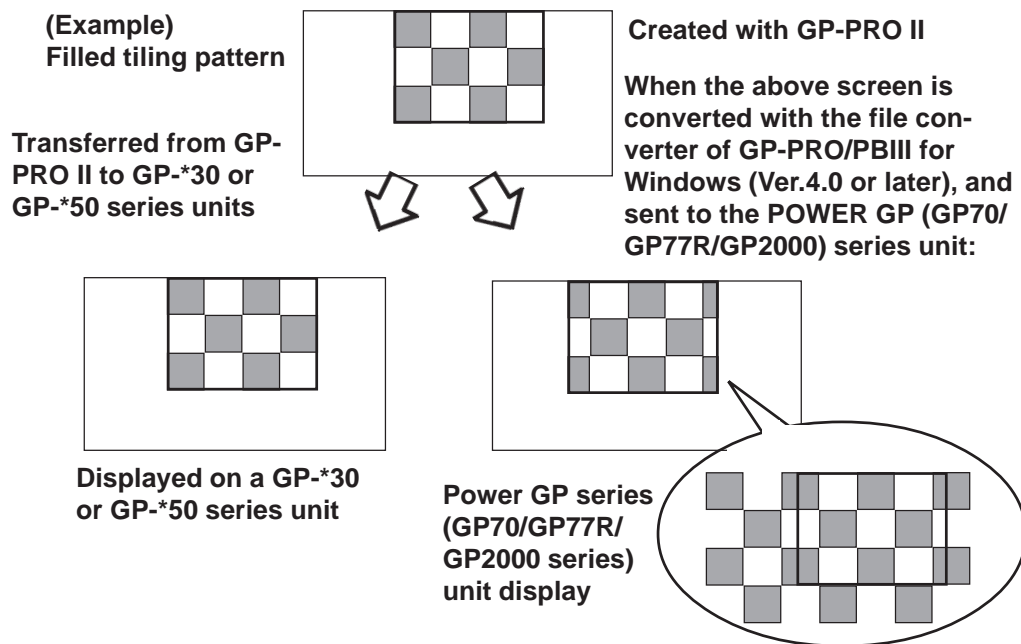

■ **Fill-in areas**

When painted objects drawn with the GP-PRO, GP-PRO II, GP-PRO III, or GP-PRO/PB III (DOS Version) are converted into data for GP-PRO/PB III for Windows, the object may appear to be incompletely painted. Modify the converted objects as necessary with GP-PRO/PB III for Windows.

■ **Converting "Parts Box" Data**

The GP-PRO/PB III for Windows file converter can convert Parts Box screen data for use as GP70/GP77R/GP2000 series unit data.

 **Reference** 12.1 *File Converter*

■ **Data Conversion from LT Editor**



**Note:** This function is available only when GP-PRO/PB III C-Package is installed.

GP-PRO/PB III for Windows Ver.7.2 can open screen data from LT Editor. Select the LT Project File (\*.LTE) in the "Files of type" field in the "Select" dialog box.

 **Reference** 1.1.2 ■ *Selecting an Existing Project*

## WHEN USING GLC 2000 SERIES UNITS

- GLC2000 Series units are equipped with the same features as GP2000 units, with the addition of control-related features. As a result, please change the word “GP” to “GLC” when reading this manual. However, please remember that GLC Series units cannot use AUX output or Sound output.  
Be sure to understand this manual thoroughly before using your GLC unit.
- For information concerning Logic Program creation and editing, refer to Pro-Control editor's manuals and online help.

## WHEN USING ST SERIES UNITS

ST Series units are functionally equivalent to GP2301L Series units. In this manual, you can use the terms “ST” and “GP” interchangeably. When GP2000 Series usage restrictions are noted, change the term “GP2000 Series” to “ST” series. When detailed GP-2301L restrictions are noted, change the term “GP-2301L” to “ST”. Note that the ST403 units support the Ethernet interface. However, ST units have certain restrictions owing to hardware specification differences with GP-2301L units. Be sure to understand this manual thoroughly before using your ST unit. Functions incompatible with your ST unit, **Reference** [GENERAL GP RESTRICTIONS] section, 2.12.2 Restrictions

## WHEN USING LT SERIES UNITS

- 64-color-type LT Series units are functionally equivalent to GP70 Series GP-377S Series units, and Monochrome-type LT Series units are functionally equivalent to GP-377L Series units. When GP70 Series usage restrictions are noted, interchange the term “GP70 Series” with “LT”. When detailed GP-377S/GP-377L restrictions are noted, 64-color-type LT Series units can be read as GP70 Series GP-377S Series units and Monochrome-type LT Series units can be read as GP-377L Series units.
- Only LT Type C Series units can be connected to a Temperature Controller, Servo, Inverter or Analyzer. (Using the serial-type interface. See LT Series Unit User Manual.)  
For a complete list of all connectable Devices (Temperature Controllers, Servos, Inverters or Analyzers) **Reference** Device/PLC Connection Manual.
- For information concerning Logic Program creation and editing, refer to Pro-Control editor's manuals and online help.

# TABLE OF CONTENTS

PREFACE .....	1
TRADEMARK RIGHTS .....	2
LIST OF SUPPORTED MODELS .....	3
NEW FEATURES OF VERSION 7.0 .....	6
NEW FEATURES OF VERSION 7.1 .....	11
NEW FEATURES OF VERSION 7.2 .....	12
HOW TO USE THIS MANUAL .....	14
MANUAL SYMBOLS AND TERMINOLOGY .....	17
PRECAUTIONS .....	20
GENERAL GP RESTRICTIONS .....	21
GP SERIES COMPATIBILITY .....	44
WHEN USING GLC 2000 SERIES UNITS .....	47
WHEN USING ST SERIES UNITS .....	47
WHEN USING LT SERIES UNITS .....	47
TABLE OF CONTENTS .....	48
<b>CHAPTER 1 FUNDAMENTALS OF GP-PRO/PB III FOR WINDOWS</b>	
<b>1.1 From Start to Finish .....</b>	<b>1-2</b>
1.1.1 Getting Started .....	1-2
1.1.2 Creating/Selecting/Saving a Project .....	1-3
1.1.3 Opening/Closing/Saving a Screen .....	1-10
1.1.4 Quitting GP-PRO/PBIII for Windows .....	1-15
<b>1.2 Project Manager .....</b>	<b>1-16</b>
1.2.1 Project Manager Areas and Functions .....	1-16
<b>1.3 Screen Editor .....</b>	<b>1-18</b>
1.3.1 Screen Editor Item Names and Functions .....	1-18
1.3.3 Tool/Icon Display .....	1-21
1.3.2 Display Area (50%, 100%, 200%) .....	1-21
<b>1.4 GP-PRO/PB III Manuals and Help .....</b>	<b>1-22</b>
1.4.1 Browsing Help Topics .....	1-23
1.4.2 PDF Manuals .....	1-25
1.4.3 Connecting to the Home Page .....	1-26
1.4.4 Using “Otasuke Pro!” .....	1-29



## CHAPTER 2 CREATING BASE SCREENS

<b>2.1</b>	<b>Parts .....</b>	<b>2-2</b>
2.1.1	Bit Switches .....	2-24
2.1.2	Word Switches .....	2-29
2.1.3	Function Switches .....	2-33
2.1.4	Toggle Switches .....	2-39
2.1.5	Lamps .....	2-43
2.1.6	4-State Lamp .....	2-46
2.1.7	Bar Graphs .....	2-49
2.1.8	Pie Graphs .....	2-54
2.1.9	Half Pie Graphs .....	2-59
2.1.10	Tank Graphs .....	2-64
2.1.11	Meter Graphs .....	2-69
2.1.12	Trend Graphs .....	2-74
2.1.13	Keypads .....	2-86
2.1.14	Keypad Display .....	2-90
2.1.15	Alarm Display .....	2-112
2.1.16	File Name Display .....	2-117
2.1.17	Data Logging Display .....	2-123
2.1.18	Data Transfer Display .....	2-129
2.1.19	CSV Display .....	2-135
2.1.20	File Manager Display .....	2-142
2.1.21	Numeric Displays .....	2-146
2.1.22	Message Display .....	2-151
2.1.23	Date Displays .....	2-158
2.1.24	Time Displays .....	2-161
2.1.25	Picture Displays .....	2-163
2.1.26	Window Parts .....	2-168
<b>2.2</b>	<b>Drawing .....</b>	<b>2-171</b>
2.2.1	Dot .....	2-173
2.2.2	Line/Poly-line .....	2-174
2.2.3	Square/Rectangle .....	2-176
2.2.4	Circle/Oval .....	2-178
2.2.5	Arc/Pie .....	2-180
2.2.6	Fill .....	2-182
2.2.7	Line / Polygon .....	2-184

## TABLE OF CONTENTS

2.2.8	Scale .....	2-186
2.2.9	Text .....	2-189
2.2.10	Load Screens .....	2-195
2.2.11	Load Mark .....	2-199
2.2.12	Convert (Import) Image .....	2-201
<b>2.3</b>	<b>Tags .....</b>	<b>2-202</b>
2.3.1	Designating Tags .....	2-205
<b>2.4</b>	<b>Object Editing .....</b>	<b>2-208</b>
2.4.1	Selecting Objects .....	2-209
2.4.2	Moving Objects .....	2-215
2.4.3	Scaling Up/Down .....	2-216
2.4.4	Cut .....	2-217
2.4.5	Copy .....	2-218
2.4.6	Paste .....	2-219
2.4.7	Duplicate .....	2-220
2.4.8	Delete .....	2-226
2.4.9	Align .....	2-227
2.4.10	Rotate Left/ Rotate Right .....	2-228
2.4.11	Mirror X/ Mirror Y .....	2-230
2.4.12	Group/Ungroup .....	2-232
2.4.13	Bring to Front/ Send to Back .....	2-234
2.4.14	Changing Attributes .....	2-235
2.4.15	Changing Coordinates .....	2-237
2.4.16	Editing the Node of a Multi-segment Line .....	2-238
2.4.17	Transferring a Screen to the Clipboard .....	2-239
2.4.18	Converting a Screen to a Bitmap File .....	2-240
2.4.19	Redraw Screen .....	2-242
2.4.20	Undo .....	2-243
2.4.21	Redo .....	2-243
<b>2.5</b>	<b>Libraries .....</b>	<b>2-244</b>
2.5.1	Registering Library Items .....	2-248
2.5.2	Placing Library Items .....	2-253
2.5.3	Editing Library Items .....	2-255
2.5.4	Saving Libraries and Quitting .....	2-260
<b>2.6</b>	<b>D-Script/Global D-Script .....</b>	<b>2-262</b>

<b>2.7</b>	<b>Extended SIO Script .....</b>	<b>2-269</b>
<b>2.8</b>	<b>Data Sampling .....</b>	<b>2-274</b>
<b>2.9</b>	<b>GLOBAL INTERLOCK .....</b>	<b>2-277</b>
<b>2.10</b>	<b>Efficient Drawing Techniques .....</b>	<b>2-279</b>
2.10.1	Grid/Snap .....	2-279
2.10.2	Screen Property Settings .....	2-282
2.10.3	Preview Screen.....	2-287
2.10.4	Screen Data List.....	2-288
2.10.5	Part Reference List .....	2-290
2.10.6	Tag List.....	2-293
2.10.7	Cross Reference List.....	2-295
2.10.8	Load Screen List .....	2-301
2.10.9	Display of Screen Level Change Structure .....	2-303
<b>2.11</b>	<b>Creating Handy-type GP Screen .....</b>	<b>2-304</b>
2.11.1	Function Keys .....	2-305
2.11.2	Setting Up the Operation Switch .....	2-309
2.11.3	Vibration Function .....	2-311
<b>2.12</b>	<b>Creating ST Series Screen.....</b>	<b>2-319</b>
2.12.1	Function Keys .....	2-321
2.12.2	Backlight Color Change .....	2-324
2.12.3	Restrictions .....	2-330
<b>2.13</b>	<b>DXF Conversion .....</b>	<b>2-333</b>
2.13.1	Conversion from DXF File to Base Screen (DXF ® PRW) ...	2-333
2.13.2	Conversion from Base Screen to DXF File (PRW ® DXF) ..	2-339

## CHAPTER 3 DRAWING APPLICATIONS - CREATING AND USING SCREENS

<b>3.1</b>	<b>Creating a Mark: the Mark Screen .....</b>	<b>3-2</b>
3.1.1	Drawing a Mark .....	3-4
3.1.2	Special Mark Characters .....	3-12
3.1.3	Editing a Mark .....	3-15
3.1.4	Registering and Placing a Mark Library Item.....	3-25
<b>3.2</b>	<b>Creating a Trend Graph: the Trend Graph Screen .....</b>	<b>3-26</b>
<b>3.3</b>	<b>Creating a Keypad: the Keypad Screen .....</b>	<b>3-32</b>
<b>3.4</b>	<b>Text Input: the Text Screen.....</b>	<b>3-37</b>
3.4.1	Editing Text.....	3-40

TABLE OF CONTENTS

3.4.2	Editing MultiLanguage Text Screens .....	3-46
3.4.3	Text Screen Import/Export .....	3-50
<b>3.5</b>	<b>Creating an Image: the Image Screen .....</b>	<b>3-56</b>
3.5.1	Image Conversion .....	3-56
3.5.2	Compressing/Decompressing an Image Screen .....	3-62
<b>3.6</b>	<b>Video Data Display (V Screen) .....</b>	<b>3-64</b>
3.6.1	Video Settings .....	3-70
3.6.2	Video Window Settings .....	3-71
<b>3.7</b>	<b>Window Display: Window (U) Screen and Base (B) Screen .....</b>	<b>3-74</b>
3.7.1	Overview of Window Display .....	3-74
3.7.2	Window Registration on the U Screen .....	3-76
3.7.3	Window Registration on the B Screen .....	3-79
<b>CHAPTER 4 SCREEN AND PROJECT MANAGEMENT</b>		
<b>4.1</b>	<b>Screen Editing .....</b>	<b>4-2</b>
4.1.1	Listing/Copying/Deleting Screen .....	4-2
4.1.2	Copying Screens from Other Projects .....	4-7
<b>4.2</b>	<b>Project Editing .....</b>	<b>4-11</b>
4.2.1	Deleting Project Files .....	4-11
4.2.2	Backing up Project Files .....	4-12
4.2.3	Rebuilding A Project (Rebuild) .....	4-13
4.2.4	Converting Addresses and Device Codes .....	4-16
4.2.5	Convert Load Screens.....	4-18
4.2.6	Changing a Project's GP Type .....	4-20
4.2.7	Changing Your Project's Device/PLC Type and Addresses .....	4-22
4.2.8	Changing Extend SIO Type.....	4-32
4.2.9	Protect Setting .....	4-38
<b>4.3</b>	<b>Project Compression/Decompression .....</b>	<b>4-40</b>
4.3.1	Compressing a Project File .....	4-41
4.3.2	Decompressing a Project File .....	4-44
<b>4.4</b>	<b>Comparing Projects.....</b>	<b>4-46</b>
<b>4.5</b>	<b>Information Display .....</b>	<b>4-49</b>
4.5.1	Project Information .....	4-49
4.5.2	Screen Information .....	4-51
4.5.3	Version Information .....	4-52
<b>4.6</b>	<b>Table Editor Character Strings.....</b>	<b>4-53</b>

4.6.1	Overview: Multi-language Display Feature .....	4-53
4.6.2	Table Editor Character Strings .....	4-55
4.6.3	Entering Settings via the Screen Editor .....	4-61
4.6.4	Text Table Converter .....	4-65
<b>4.7</b>	<b>Security Feature .....</b>	<b>4-68</b>
4.7.1	Overview .....	4-68
4.7.2	Password Settings .....	4-71
4.7.3	Security Level List .....	4-77
<b>4.8</b>	<b>Time Schedule .....</b>	<b>4-79</b>
4.8.1	Overview .....	4-79
4.8.2	Entering Time Schedule Settings .....	4-80
<b>4.9</b>	<b>Symbol Editor .....</b>	<b>4-91</b>
<b>4.10</b>	<b>Device Monitor .....</b>	<b>4-100</b>
<b>CHAPTER 5 CREATING AND EDITING ALARMS</b>		
<b>5.1</b>	<b>Alarm Creation and Editing .....</b>	<b>5-2</b>
5.1.1	Alarm Editor .....	5-3
5.1.2	Creating an Alarm .....	5-15
5.1.3	Editing Alarm Data .....	5-17
5.1.4	Alarm Import/Export .....	5-26
<b>CHAPTER 6 GP INITIAL AND SYSTEM SETTINGS</b>		
<b>6.1</b>	<b>Menu Setting Items: GP Setup .....</b>	<b>6-2</b>
<b>6.2</b>	<b>Printer Type .....</b>	<b>6-11</b>
6.2.1	Epson PM Series / Epson Stylus Series .....	6-11
<b>CHAPTER 7 TRANSFERRING DATA</b>		
<b>7.1</b>	<b>Prior to Transferring Data .....</b>	<b>7-2</b>
7.1.1	GP Screen Transfer Cable .....	7-2
<b>7.2</b>	<b>Transferring Screens .....</b>	<b>7-3</b>
7.2.1	Transfer Settings .....	7-4
7.2.2	Passwords .....	7-11
7.2.3	2-Way Driver .....	7-14
7.2.4	Transfer Preparation .....	7-15
7.2.5	When Sending Screens To the GP .....	7-16
7.2.6	When Receiving Data From the GP .....	7-18
7.2.7	Sending/Receiving Dictionary File .....	7-20
7.2.8	Start GP-Web Compiler .....	7-21

<b>7.3</b>	<b>Options</b> .....	<b>7-22</b>
7.3.1	GP Internal Screen Data Information .....	7-22
<b>7.4</b>	<b>Setting Up Your GP via an Ethernet Network</b> .....	<b>7-27</b>
7.4.1	Data Transfer Using the Factory-set IP Address .....	7-31
<b>CHAPTER 8 SIMULATION</b>		
<b>8.1</b>	<b>Overview</b> .....	<b>8-2</b>
8.1.1	General Description of the Simulation Screen .....	8-4
8.1.2	Transferring Simulation Protocol .....	8-10
8.1.3	Performing a Simulation .....	8-11
8.1.4	Simulation (Ethernet) .....	8-13
8.1.5	Snapshot Function .....	8-16
<b>CHAPTER 9 PRINTING</b>		
<b>9.1</b>	<b>Print Settings</b> .....	<b>9-2</b>
9.1.1	Printing .....	9-2
9.1.2	Print Preview .....	9-8
<b>9.2</b>	<b>Sample Printer Output</b> .....	<b>9-9</b>
<b>CHAPTER 10 ADVANCED FEATURES</b>		
<b>10.1</b>	<b>Sound Output</b> .....	<b>10-2</b>
<b>10.2</b>	<b>Filing Data (Recipe)</b> .....	<b>10-2</b>
<b>10.3</b>	<b>CSV Data Transfer Function</b> .....	<b>10-3</b>
<b>10.4</b>	<b>Logging</b> .....	<b>10-3</b>
<b>10.5</b>	<b>CF Card</b> .....	<b>10-4</b>
10.5.1	Using CF Card Tools .....	10-4
<b>10.6</b>	<b>Creating/Transferring CF Memory Loader Tool</b> .....	<b>10-9</b>
10.6.1	CF Memory Loader Tool / Backup Data .....	10-9
10.6.2	CF Memory Loader Settings .....	10-14
10.6.3	Creating System Boot Data for CF Card.....	10-16
10.6.4	Sending System Boot Data to CF Card .....	10-17
10.6.5	Creating Backup Data.....	10-18
10.6.6	Creating a PRW file .....	10-19
10.6.7	Sending Backup Data .....	10-20
10.6.8	Receiving Backup Data .....	10-20
10.6.9	Transferring “CF Memory Loader Tool” data via CF Card Tool.....	10-21
<b>10.7</b>	<b>CF Memory Loader Tool</b> .....	<b>10-22</b>
10.7.1	About "CF Memory Loader Tool" .....	10-22

10.7.2 Starting the "CF Memory Loader Tool" ..... 10-23  
 10.7.3 MEMORY LOADER TOOL ..... 10-24  
 10.7.4 Menu Screen ..... 10-25  
 10.7.5 Self Diagnosis ..... 10-37

**CHAPTER 11 PROJECT MANAGER HIERARCHICAL DISPLAY**

**11.1 Project Manager - Hierarchical Display ..... 11-2**  
**11.2 Using Hierarchical Display Mode ..... 11-3**

**CHAPTER 12 DATA COMPATIBILITY**

**12.1 File Converter ..... 12-2**  
 12.1.1 Conversion from GP-PRO II or GP-PRO III ..... 12-2  
 12.1.2 Conversion from Parts Box ..... 12-8  
 12.1.3 GP-\*10 (GPM) File Conversion ..... 12-11  
 12.1.4 Reading GP-\*10 (GPM) Files ..... 12-16

**APPENDICES**

**A.1 Error Messages ..... App-2**  
**A.2 Troubleshooting ..... App-23**  
 A.2.1 Troubleshooting List App-23  
 A.2.2 Buzzer will not Stop/No Display on the GP/Transfer Disabled ... App-25  
**A.3 Address Conversion Tables ..... App-29**  
**A.4 Software Trouble Report ..... App-81**

**INDEX**

# *Memo*



**T**his chapter describes GP-PRO/PB III for Windows' basic operations such as how to start and quit the software. It also explains the Project Manager and Screen Editor areas, which are used for the majority of screen creation work. Also, a number of tools are introduced here, such as online help, which provide explanations of GP-PRO/PB III for Windows' functions and operations.

<b>1.1</b>	.....	<b>From Start to Finish</b>
<b>1.2</b>	.....	<b>Project Manager</b>
<b>1.3</b>	.....	<b>Screen Editor</b>
<b>1.4</b>	.....	<b>GP-PRO/PB III Manuals and Help</b>

# 1.1 From Start to Finish



This section describes the GP-PRO/PB III for Windows program's operation flow from start to finish.

Usage Pattern			
<b>Start</b>	→ Create/Select a project file with the Project Manager.	→ Create/Edit a screen with the Screen Editor.	→ Save the screen, and quit the Screen Editor. → Save the project, and quit the Project Manager.

## 1.1.1 Getting Started

### ■ Starting GP-PRO/PB III for Windows

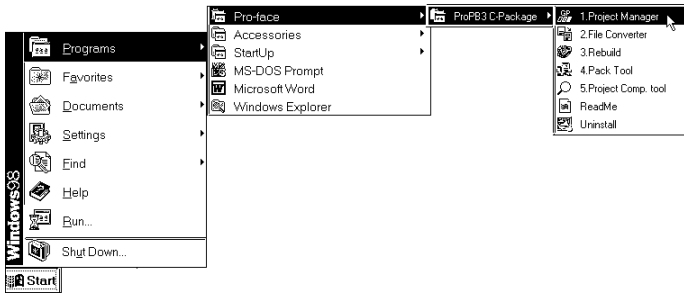
The following explanation assumes your PC is turned on and the Windows desktop has appeared.

PROCEDURE	REMARKS
<p>(1) Click on the [Start] button, and point to the [Programs] - [Pro-face] - [ProPB3 C-Package] menu. Then, click on the [1. Project Manager] command.</p> 	<p>If you double-click directly on a previously made project file (*.PRW file) via the Explorer software, GP-PRO/PB III for Windows will automatically start.</p>
<p>(2) The Project Manager screen appears.</p> 	

## 1.1.2 Creating/Selecting/Saving a Project

A project file (PRW file) normally contains multiple screens intended for the operation of a certain system. GP-PRO/PB III for Windows creates one project file for the operation of one system, enabling system management by project file units.

You can send the screen data of one project file or individual screens of the same project file to the GP unit. Screens of different project files cannot be used simultaneously on the GP unit.

### ■ Creating a New Project

Before creating a new project, designate the GP type, serial interface selection, Device and Extend SIO information according to your current application.

#### ◆ GP Type

Select your Device/PLC Type according to the series of the Device/PL Type

▼ **Reference** ▲ *LIST OF SUPPORTED MODELS*

#### ◆ Serial interface selection

Specify whether to change the destination of the serial interface and the Extend Serial Interface before selecting/changing the device or the extended SIO. This feature is available only with the GP-2000 Series.

▼ **Reference** ▲ *4.2.7 Changing Your Project's Device/PLC Type and Addresses, 4.2.8 Changing Extended SIO Type*

▼ **Reference** ▲ *Page 27 General GP Restrictions ■ Extended SIO Script*

#### ◆ Device/PLC Type

Select the type of Device/PLC to be connected to your GP unit.

▼ **Reference** ▲ *Device/PLC Connection Manual*

#### ◆ Extend SIO Settings

Select the type of Extend SIO.

This feature can be selected only when the GP-2000 series is selected as the GP Type.

##### • Serial Code Reader (LS)

Select this option when connecting a Two-Dimensional Code Reader to the extended serial interface.

▼ **Reference** ▲ *Tag Reference Manual, 4.8.2 Compatible Serial-code readers*

##### • General SIO Protocol

Select this option when using extended SIO functions with D-script.

▼ **Reference** ▲ *Tag Reference Manual, 3.1.11 Example Communication Using Extended SIO*

- **Serial Code Reader (K-tag)**

Select this option when connecting a One-Dimensional Code Reader to the extended serial interface.

**▼Reference▲** *Tag Reference Manual, 4.9 Bar-Code Reader Compatibility*

- **Extended SIO Script Protocol**

Select this option when using the Extended SIO Functions with the Extended SIO Script.

**▼Reference▲** *2.7 Extended SIO Script, Tag Reference Manual 3.2 Extended SIO Script*

PROCEDURE	REMARKS
-----------	---------



(1) Select the Project Manger's [Project] menu - [New] command, or click on  .

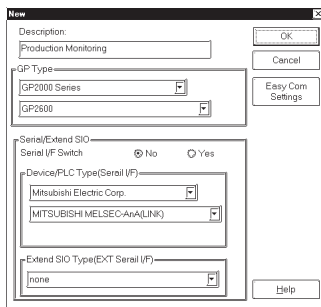

(2) Enter a description and select a GP Type, serial interface and Device/PLC Type from the pull-down menu. Make the settings for Extended SIO Settings as necessary.



Click the [OK] button in step (2) to skip step (3) and jump to step (4).

(3) Click the  button to enable [Mode Settings], [System Area Settings] and [Communication Settings] for the PLC Type selected in step (2). When all settings are completed, press the  button.

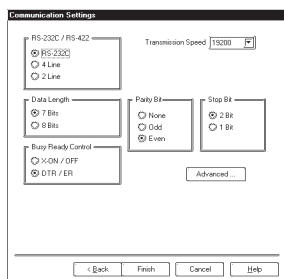

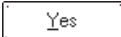
(4) The GP-PRO/PBIII for Windows system will then ask you if you wish to create a screen. If you click on the  button, the Screen Editor will start and you can begin laying out your screen.

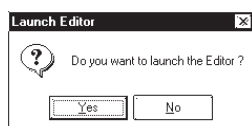

When entering a description, you can use up to 60 single-byte characters.

**Reference** *Device/PLC Connection Manual*

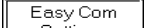
The settings on the left can also be made by clicking  in the Project Manager. When setting the “Serial I/F Switch” feature to “Yes” in a GP2000 Series unit that does not have Extend Serial I/F, you cannot use the  button.

**Reference** *1.1.3 Opening/Closing/Saving a Screen*



**Note:** If you attempt to create another project file without saving a newly created project file, the system asks if you wish to save the current file. If you click on the  button, the [Save As] dialog box appears. If you click on the  button, the system opens a new screen without saving the current project file.

**Reference** 1.1.2 ■ Saving a Project File under a Different Name

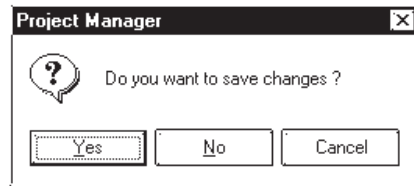

■ Selecting an Existing Project

Select the Project Manger's [Project] menu - [Select] command, or click on



. When you select a project, the following setting screen appears:

Used to select the folder containing the target project file

Used to display the folder of the preceding level

Used to create a new folder

Used to display a file list

Used to display a detailed file list

Lists the current folder and existing project files

Displays the project file name selected from the list. You can specify the project file by typing the file name

Displays the project file's comment and the selected GP unit, Device/PLC Type and Extend SIO Setting

Used to select the project file type desired

◆ File Types



You can select either a project file created with the DOS version of GP-PRO/PB III (DOS project file: \*.PRO), a project file created with GP-PRO/PB III for Windows (project file: \*.PRW), or a project file created with LT Editor (project file:\*.LTE).



**Important** If you specify the GP type as "GP570VM" in a DOS project file, and the GP type is not recognized as "GP570VM" in GP-PRO/PB III for Windows, then re-register the GP type as "GP570VM" in the Windows version.

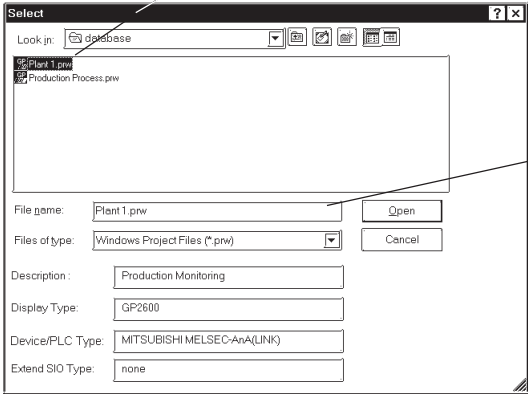

- Double-clicking on the file (project file: \*.PRW) itself in Explorer automatically starts GP-PRO/PB III for Windows and opens the file.
- Dragging and dropping an \*.lte file in the Project Manager will not automatically open it.

PROCEDURE	REMARKS
<p>(1) Select the Project Manger [Project] menu's [Select] command, or click on .</p> <p>(2) Select a project file from the list that appears, or type the project file name. Select "Factory A"</p>  <p>To type a file name via the keyboard, type the file name here.</p>	<p>To select a project file located in another folder, find a desired file from the "Look in: (File location)".</p> <p>To select a file created with the DOS version of GP-PRO/PB III, select "DOS Project File (*.pro)" in "File Type:".</p>
<p>(3) Click on the  button to open the selected file.</p>	<p>When you double-click on the file name selected in step (2), you can skip the  command.</p> <p><b>Reference</b> To create a screen, refer to <i>1.1.3 Opening/Closing/Saving a Screen</i>.</p>

■ Saving a Project

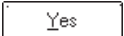

When the data of an existing project file is changed, the changes will be automatically saved.

However, if you attempt to create a another new project file without first saving your current project file, the GP-PRO/PBIII will ask if you wish to save the current file. If you click on the  button, the [Save As] dialog box will appear.

**Reference** 1.1.2 ■ Saving a Project File under a Different Name

## ■ Saving a Project File under a Different Name

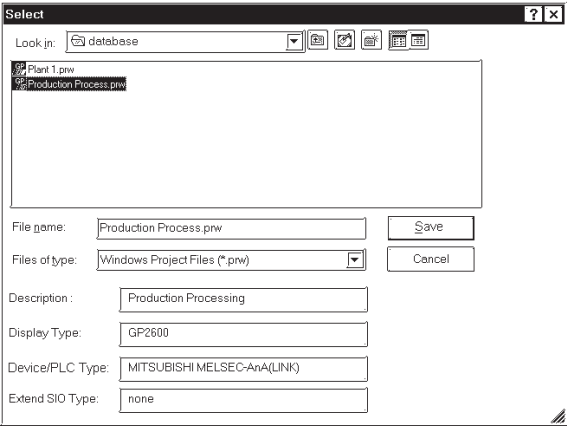
You can save an existing project file under a different name or with different GP type, Device/PLC type and Extend SIO settings.

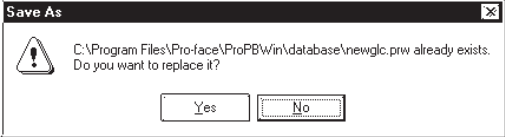
PROCEDURE	REMARKS
<p>(1) Select the [Project] menu - [Save As] command in the Project Manager.</p> <p>(2) The comment, GP type, Device/PLC type and Extend SIO of the currently opened project file are displayed.</p> <p>Enter the desired file name, and enter the items to be changed.</p> 	<p>The file name can contain up to 255 characters (including the path-name and extension.)</p> <p> <b>Important</b></p> <p><b>Before changing the GP type, check the preset data, since the drawing area and functions vary depending on the type of the GP unit.</b></p> <p><b>Reference</b> 4.2.6 Changing a Project's GP Type</p> <p> <b>Important</b></p> <p><b>Once the Device/PLC type is changed, you must change the addresses of the Parts, Tags, D-Scripts and alarms, and perform the GP system setup again.</b></p> <p><b>Reference</b> 4.2.7 Changing Your Project's Device/PLC type and Addresses</p>
<p>(3) Click on the <input type="button" value="Save"/> button to save the file.</p> <p>If a project file with the same name exists, GP-PRO/PBIII will ask if you want to replace (overwrite) the existing project file with the project file you are attempting to save.</p> <p>If so, click on the <input type="button" value="Yes"/> button. If you do not wish to overwrite the existing project file, click on the <input type="button" value="No"/> button.</p> 	<p><b>Reference</b> To open another project file, see 1.1.2 ■Creating a New Project or ■Selecting an Existing Project.</p> <p><b>Reference</b> To close GP-PRO/PBIII for Windows, see 1.1.4 Quitting GP-PRO/PBIII for Windows.</p>





- **When a Vertical GP unit is replaced with the horizontal type, or vice-versa, the displayed screen will rotate 90° relative to the original data. In this case, you must edit the displayed data using the [Rotate] command. After editing, be sure to check the displayed data.**

Example)



Horizontal type







Vertical type

- **When a high-resolution type GP unit is replaced with a low-resolution type, high-resolution data can no longer be displayed. If the low-resolution type GP unit is again replaced with a high-resolution type and the same project file is used, the data will once again be displayed.**  
**Before changing the [GP Type] setting, be sure to use the Screen Editor to check the changed display.**  
**Select [Option], [Screen Settings] and the [Display Area] tab.**  
**Then, select the resolution of the new GP Type, and click [OK].**  
**A frame will appear on the Screen Editor to show the display range at the specified resolution. You can then move your data into the frame.**
- **The maximum number of characters used for an alarm summary in the low-resolution type is different from that of the high-resolution type. When an alarm message created with the high-resolution type is used in a low-resolution type, data extending beyond the message area will not be displayed.**

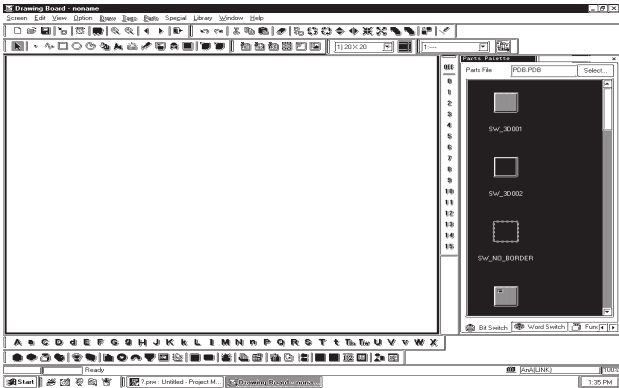

**1.1.3 Opening/Closing/Saving a Screen**

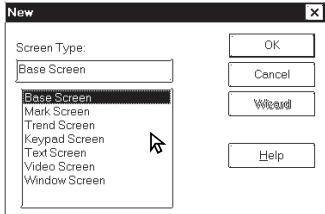
After selecting a project file, you can create a screen. First, you must move from the Project Manager to the Screen Editor, and open a screen. This section describes the procedures for opening, closing, and saving a screen.

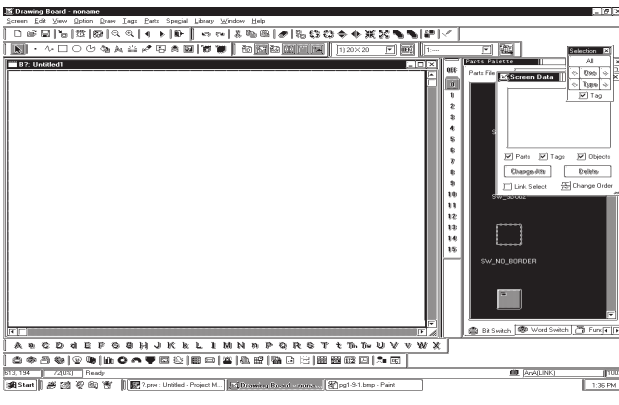
**Opening a New Screen**

PROCEDURE	REMARKS
<p>(1) Select the Project Manger's [Screen/Setup] menu - [Editor] command, or click on  . The Screen Editor's opening screen will appear.</p> 	<p>When the Screen Editor has already been started, skip step (1).</p>
<p>(2) Select the Screen Editor [Screen] menu's - [New] command, or click on  .</p> <p>(3) Select the screen type.</p> 	<p>Selecting the [Screen] menu's - [Open] command or clicking on  and entering an unregistered screen number can also be used to open a new screen.</p> <p>Enter the screen number and title when saving the screen.</p> <p><b>Reference</b> 1.1.3 ■ Saving a Screen under a Different Name</p>
<p>(4) Click on the  button to create the desired type of screen. The designated GP type's drawing screen will appear.</p> 	<p>Up to twenty screens can be simultaneously opened.</p> <p>Multiple types of windows can be opened on any one screen at the same time.</p>

■ Opening a Previously Saved Screen

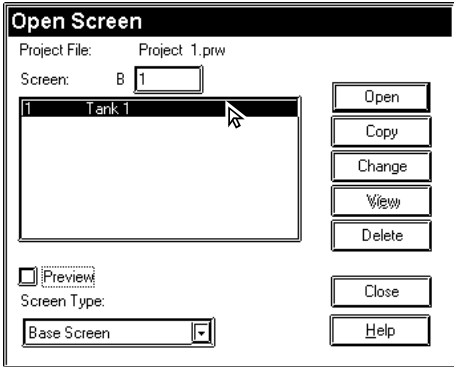
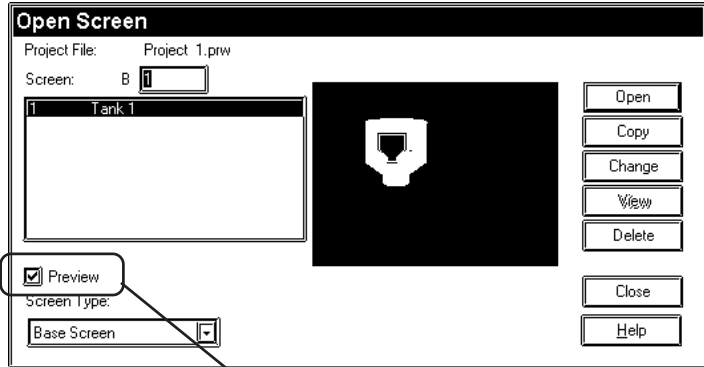
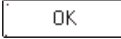
PROCEDURE	REMARKS
<p>(1) Select the [Screen/Setup] menu's - [Editor] command, or click on  in the Project Manager.</p> <p>The Screen Editor's opening screen will appear.</p> <p>(2) Select the [Screen] menu's - [Open] command or click on .</p> <p>(3) Use this screen to select a screen name from the list, or select the screen type and enter the screen number.</p> <p>When checking the [Preview] check box, the selected screen image can be viewed in the dialog box.</p>  <p style="text-align: center;">↓ Place a check mark in the [Preview] box.</p> 	<p>When the Screen Editor has already been started, skip step (1).</p> <p>When you double-click on the desired screen number in step (3), you can skip the operation of the  button.</p> <p>If you enter a screen number that has not been registered in the list, a new screen will be opened and that number will be assigned to it.</p> <p>When selecting multiple screens, a screen with the smallest screen number of them will be displayed.</p>

PROCEDURE	REMARKS
-----------	---------

(4) Click on the  button to open the screen.  
 The selected screen will be opened.

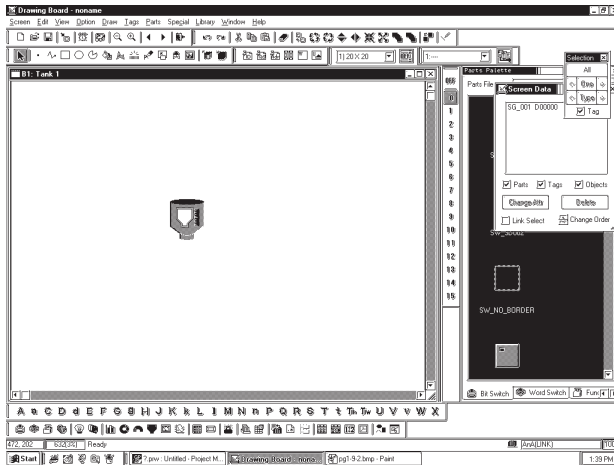

**Note:** Up to twenty screens can be open at the same time. To select several screens simultaneously, while pressing the  key, click on a screen and drag the mouse over desired adjacent screens; or, you can select screens individually by clicking on them while pressing the  key.

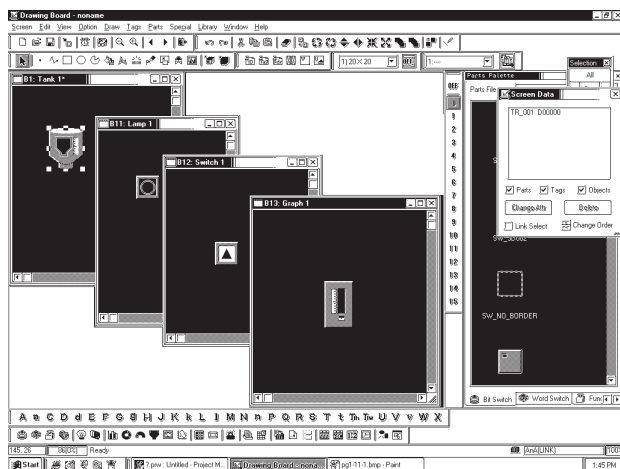
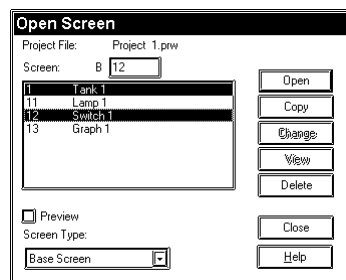

■ Saving a Screen

PROCEDURE	REMARKS
<p>(1) Select the [Screen] menu- [Save] command, or click on  in the Screen Editor.</p> <p>(2) The current screen will be saved overwriting the previous one.</p>	<p>After the screen is saved, it will remain open.</p> <p>▼ <b>Reference</b> ▼ To open another screen, see <i>1.1.3 ■ Opening a New Screen</i>.</p> <p>▼ <b>Reference</b> ▼ To quit GP-PRO/PBIII for Windows, see <i>1.1.4 Quitting GP-PRO/PBIII for Windows</i>.</p> <p>When you attempt to save a new screen, the [Save As] dialog box will appear.</p> <p>▼ <b>Reference</b> ▼ <i>1.1.3 ■ Saving a Screen under a Different Name</i></p>

■ Saving a Screen under a Different Name

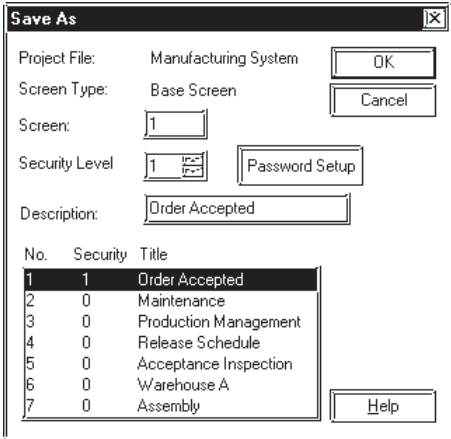
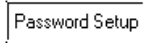
PROCEDURE	REMARKS
<p>(1) Select the [Screen] menu - [Save As] command in the Screen Editor.</p> <p>(2) The type, number, and title of the current screen is displayed.</p> <p>You can change the setting of a desired item; however, the screen's type cannot be changed.</p> 	<p>A “,” (comma) cannot be used in a description.</p> <p>When using the Security feature: Click on . For information about setting security levels, ▼ <b>Reference</b> ▼ <i>4.7 Security Feature</i></p> <p>After the screen is saved, it will remain open.</p> <p>If the screen is saved as a different screen number, the screen of the updated number will be displayed.</p> <p>▼ <b>Reference</b> ▼ To open another screen, see <i>1.1.3 ■ Opening a New Screen</i> or <i>■ Opening a Previously Saved Screen</i>.</p> <p>▼ <b>Reference</b> ▼ To quit GP-PRO/PBIII for Windows, see <i>1.1.4 Quitting GP-PRO/PBIII for Windows</i>.</p>

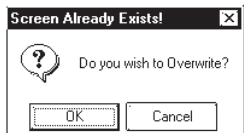
PROCEDURE	REMARKS
<p>(3) Click on the <input type="button" value="OK"/> button to register the above settings.</p> <p>If a screen with the same number exists, the system asks if you want to replace the existing screen with the screen you are attempting to save.</p> <p>If so, click on the <input type="button" value="OK"/> button. If you do not wish to overwrite the existing screen, click on the <input type="button" value="Cancel"/> button.</p> 	

**■ Closing a Screen**

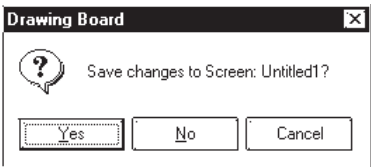
PROCEDURE	REMARKS
<p>(1) Select the [Screen] menu - [Close] command in the Screen Editor.</p> <p>(2) The screen will close.</p> <p>If you attempt to close an updated screen without saving it, the system asks if you wish to save the current screen. If you click on the <input type="button" value="Yes"/> button, the system saves the updated data. If you click on the <input type="button" value="No"/> button, the system closes the screen without saving the updated data.</p> 	<p>You can also close the screen by clicking on the <input type="button" value="X"/> button at the upper right corner of the window (drawing area).</p> <p>When you attempt to save a new screen, the [Save As] dialog box appears.</p> <p><b>▼ Reference ▲</b> 1.1.3 ■ <i>Saving a Screen under a Different Name</i></p> <p><b>▼ Reference ▲</b> To open another screen, see 1.1.3 ■ <i>Opening a New Screen</i> or ■ <i>Opening a Previously saved Screen</i>.</p> <p><b>▼ Reference ▲</b> To quit GP-PRO/PBIII for Windows, see 1.1.4 <i>Quitting GP-PRO/PBIII for Windows</i>.</p>

**1.1.4** Quitting GP-PRO/PBIII for Windows

**■ Quitting the Screen Editor**

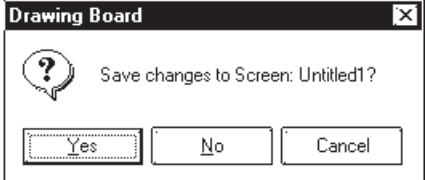
PROCEDURE	REMARKS
<p>(1) Select the [Screen] menu - [Exit] command, or click on  in the Screen Editor.</p> <p>(2) The Screen Editor will close.</p> <p>If you attempt to close the Screen Editor without first saving the currently edited screen, GP-PRO/PBIII asks if you wish to save the updated screen. If you click on the <input type="button" value="Yes"/> button, GP-PRO/PBIII saves the updated data. If you click on the <input type="button" value="No"/> button, GP-PRO/PBIII quits the Screen Editor without saving the updated data.</p> 	<p>When you save a new screen, the [Save As] dialog box appears.</p> <p><b>▼ Reference ▲ 1.1.3 ■ Saving a Screen under a Different Name</b></p>

**■ Quitting GP-PRO/PBIII for Windows**

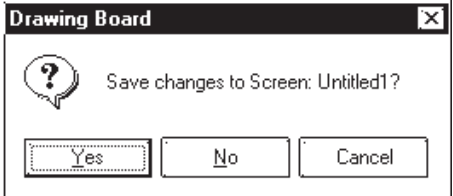
PROCEDURE	REMARKS
<p>(1) Select the [Project] menu - [Exit] command, or click on  in the Project Manager.</p> <p>(2) The Project Manger will quit.</p> <p>If you attempt to close the Project Manager without saving the currently opened screen's updated data, GP-PRO/PBIII asks if you wish to save your project's data. If you click on the <input type="button" value="Yes"/> button, GP-PRO/PBIII saves the updated data. If you click on the <input type="button" value="No"/> button, GP-PRO/PBIII quits (closes) without saving the updated data.</p> 	<p>Once you have opened the Screen Editor, you must either quit it, or go to the Project Manager.</p> <p><b>▼ Reference ▲ 1.1.4 ■ Quitting the Screen Editor</b></p>

## 1.2 Project Manager

All GP-PRO/PB III for Windows system level settings and functions are controlled via the Project Manager.

### 1.2.1 Project Manager Areas and Functions

Here, each of the Project Manager's features is explained. To begin working with GP-PRO/PBIII for Windows, simply click on the desired button.

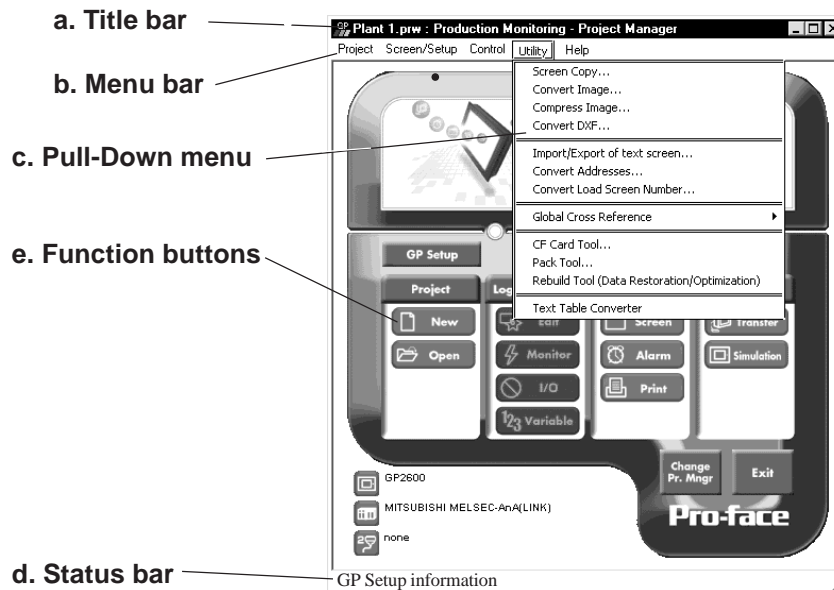

#### a. Title Bar:

Displays the current project's file name and title.

#### b. Menu Bar:

Displays the menus used for the operation of GP-PRO/PBIII for Windows. When you select a desired menu using the mouse or keyboard, one of the pull-down menus described below will appear.

#### c. Pull-Down Menu:

When you select a desired item on the menu bar, its pull-down menu appears. These menus include a variety of commands.

#### d. Status Bar:

Displays GP and Device/PLC Types as well as GP-PRO/PBIII operation related messages.



e. Function Buttons

These buttons indicate the GP-PRO/PB III for Windows program's main functions (e.g. Creating Screens/alarm, Printing). You can start each function by simply clicking on that function's button. You can also start these functions by selecting the corresponding command from the Project Manager's pull-down menu.

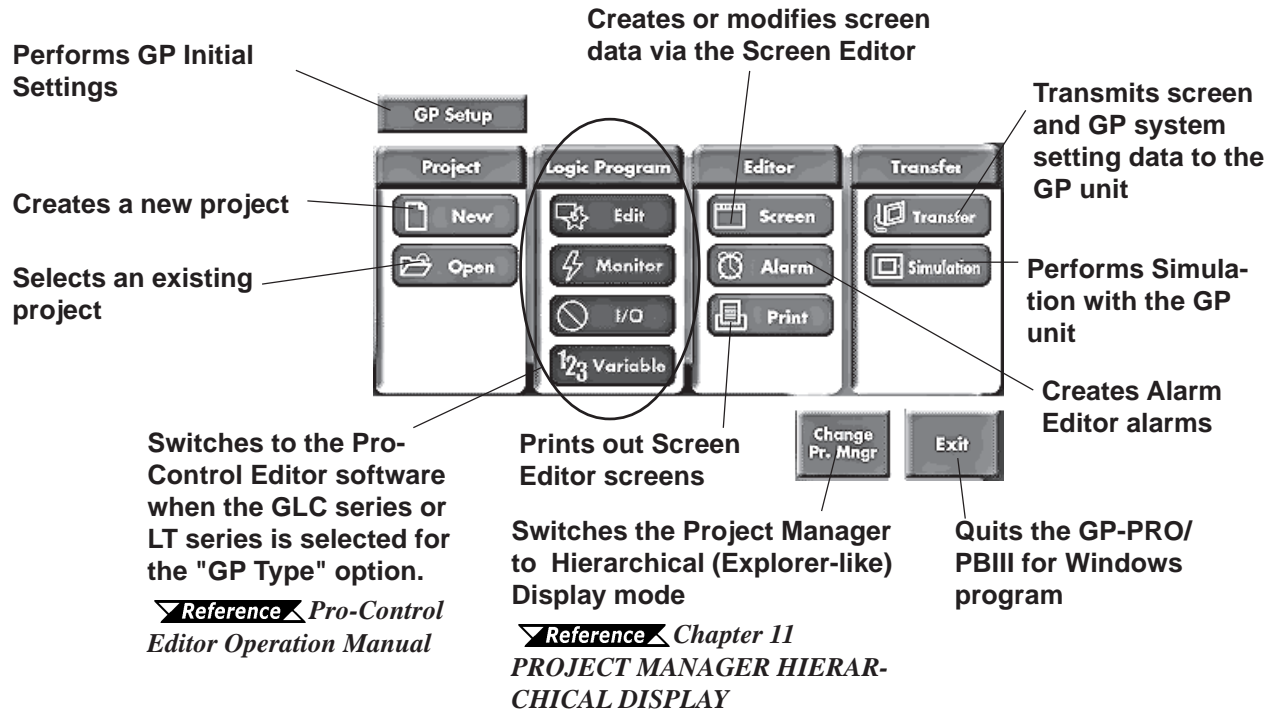

## 1.3 Screen Editor

GP operation and display screens are created in the Screen Editor.

### 1.3.1 Screen Editor Item Names and Functions

The names and functions of the GP-PRO/PBIII for Windows editor's screen items are as follows:

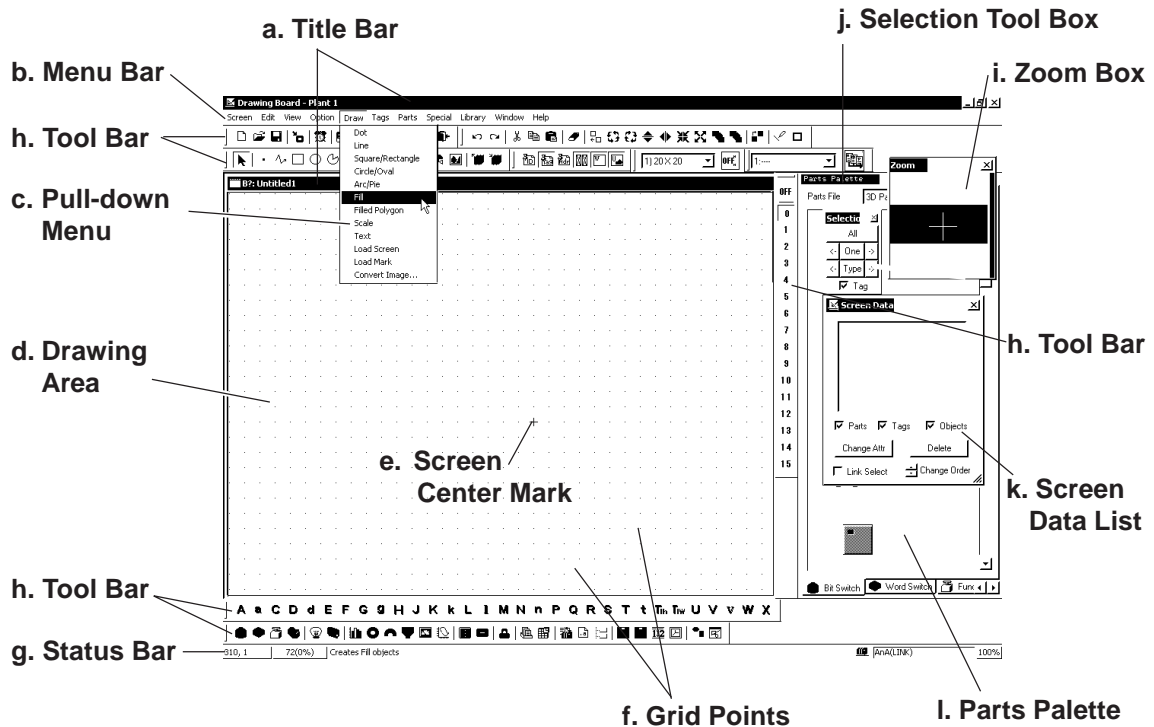

#### a. Title Bar

Displays the project file name, screen number and title.

#### b. Menu Bar

Displays the menus used to operate GP-PRO/PBIII for Windows. When you select a desired menu using the mouse or keypad, the pull-down menu (c) appears.

#### c. Pull-down Menu

When you select a desired menu from the menu bar, the pull-down menu appears. This menu includes various commands.

#### d. Drawing Area

Here, you can create a screen for your GP unit. The size of the screen you see here is designated via the "GP Type" setting you entered when you first created the project file.

Depending on the size of your PC's display, the screen's entire display area may not be displayed. In this case, simply scroll up or down to view the entire screen.

**e. Screen Center Mark**

Indicates the center of the screen. This mark is not displayed when the data is sent to the GP unit.

**f. Grid Points**

Used as reference points when you draw or paste an object in the drawing mode. Grid points will not be displayed on the GP unit's screen. The Option area's "Snap" function allows you to position your screen objects using a pre-made grid. You can also set the interval and display ON/OFF status of the grid points.

**▼ Reference ▲ 2.10.1 Grid/Snap**

**g. Status Bar**

Displays information related to the current screen and provides messages explaining the screen operation you are currently performing.

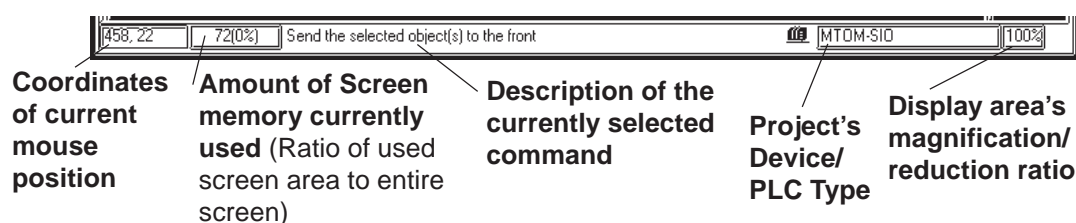
**h. Tool Bar**

The Tool Bar provides easy to use icons for drawing and editing. Clicking on one of these icons performs that command. The Tool Bar can either be hidden or displayed, and individual Tool Bar areas can be moved freely around the Screen Editor screen, i.e. top, bottom, left, or right.

The following Tool Bar areas are available:

- Main Tool Bar
- Edit Tool Bar
- Draw Tool Bar
- Option Tool Bar
- Grid/Snap Tool Bar
- Tag Tool Bar
- Parts Tool Bar
- Parts State Change Tool Bar
- Text Table Tool Bar

**i. Zoom Box**

Shows the cursor's current position at three times magnification.

**j. Selection Tool Box**

Used to select objects to be edited (Parts, Tags and figures). Using the commands included in this tool box, you can select objects using a variety of methods.

**k. Screen Data List**

Lists the settings and layout conditions of the objects (Parts, Tags and figures) that have been arranged on the screen. You can select a desired object from the list.

**Reference** *2.10.4 Screen Data List*



**l. Parts Palette**

Parts such as switches, lamps and graphs are placed on a tabbed palette (except for the keyboard, alarms, File Name Display, Logging Display, Data Transfer Display, CSV Display, File Manager Display, Picture Display, and Window parts).

To place parts on the drawing screen, simply select the desired part from the palette and place it on the screen with drag & drop operation. Only one part can be selected per operation.

### 1.3.2 Display Area (50%, 100%, 200%)

You can enlarge or reduce the drawing area by selecting a magnification/reduction ratio.

To change the display area, select the  or  icon on the tool bar, or select the [50%], [100%], or [200%] command from the [View] menu.

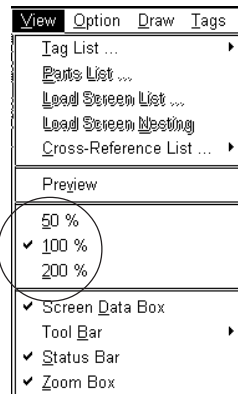

**Zoom out**    **Zoom in**

**Zoom out:** Used to reduce the current display area to 50%.

**Zoom in:** Used to enlarge the current display area to 200%.



**In the [50%] display mode, the created screen data is reduced. In this case, the displayed screen data may be different from the actual data. We recommend you to use a [100%] or larger display area.**

### 1.3.3 Tool/Icon Display

The Tag tool box, Parts tool box, tool bar, status bar and parts palette can be designated as either shown (displayed) or not shown (not displayed). Each time you select the [View] menu's [Screen Data List], [Status Bar], [Zoom Box], or [Parts Palette] as well as the [Tool Bar] command's [Main], [Edit], [Draw], [Option], [Grid/Snap], [Tag], [Parts], [Parts State Change] or [String Table] sub-commands, these View/Hide settings will toggle ON or OFF.

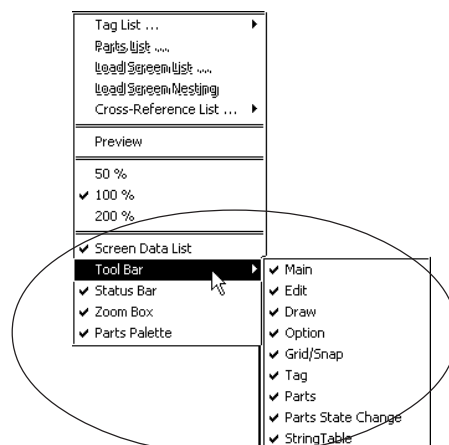

## 1.4 GP-PRO/PB III Manuals and Help

While you are learning how to use the GP-PRO/PBIII for Windows software, please refer to the following learning aids:

- Related User Manuals
- On-line Help Topics
- Digital's Home Page

For the help concerning the operation of the Windows operating system, see the Windows software's manuals and help screens.

### ■ Using GP-PRO/PBIII for Windows Manuals

The following manuals have been created for the GP-PRO/PB III for Windows software.

<b>Setup Guide</b>	Describes the system requirements, installation procedures for GP-PRO/PB III C-Package03 and the method for reading the manuals in PDF format.
<b>Operation Manual (This manual)</b>	Provides detailed program operation information.
<b>Tag Reference Manual</b>	Provides detailed descriptions of this software's special and advanced functions.
<b>Parts List</b>	Lists all the pre-made Parts included in the GP-PRO/PB III for Windows software.
<b>Device/PLC Connection Manual</b>	Describes connection methods used between the GP and the device, as well as the necessary operating environment settings.

### ■ Using the Help Feature

If you have any problems or questions during GP-PRO/PB III for Windows operation, you can view the explanations for each feature and setting via each window's Help button, or from the main menu's Help feature.

### ■ Using the Home Page

Users can obtain the latest GP-PRO/PBIII for Windows information by accessing the Digital Electronics Corporation Home Page.

**1.4.1 Browsing Help Topics**

To display the help screen, select the [Help] menu or click on the  button in the dialog box.



- *When multiple screens are loaded or many Tags and Parts have been registered on the screens, the PC's system memory may not be sufficient to display the help screen.*
- *If you jump from one topic to another on the help screen, an error message may be displayed. When this happens, simply quit and then re-start help.*

**■ Searching for a Topic and then Display Help**

Select the [Help Topics] command from the [Help] menu, or press the [F1] key. A list of help topics will be displayed.

You can search for a topic by either trying to find it from the table of contents, or entering a keyword for that topic.

**◆ Searching for a Topic from the Contents Menu**

To select a topic from the contents menu, double-click on the [Contents] tab. Follow the screen instructions to search for a desired topic.

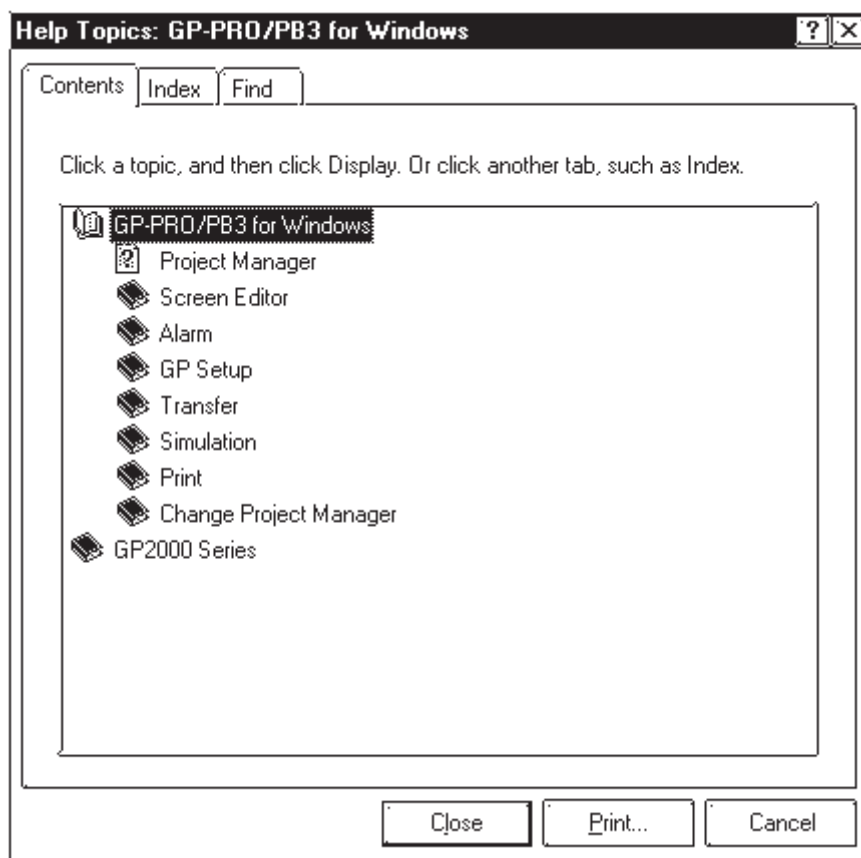

### ◆ Searching for a Topic by a Keyword

To enter a keyword, click on the [Index] tab.

Search for a desired topic according to the instruction indicated on the screen.

(When you enter initial characters of the keyword, the topics specified with these initial characters are also automatically listed)

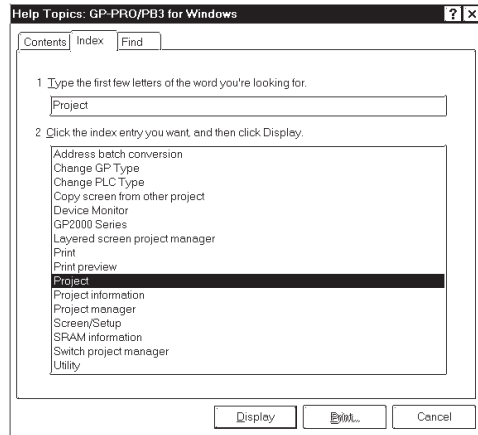

### ■ Calling up Help from a Dialog Box

When you click on the **Help** button in the dialog box or press the [F1] key during execution of a command, a description of the currently-executed command will be displayed.

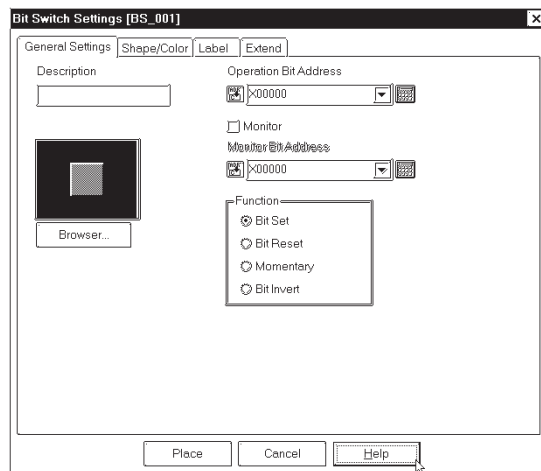



**1.4.2 PDF Manuals**

Use this feature to call up the [GP-PRO/PBIII for Windows] or [Pro-Control Editor] PDF manuals.

Usage Pattern			
· Project Manager	[Help] → [Manual]	Screen creation guide or Logic programming guide	→ Click on the desired manual name
· Screen Editor	[Help] → [Manual]		→ Click on the desired manual name
· Pro-Control Editor	[Help] → [Manual]		→ Click on the desired manual name

The following manuals explain the features of the Screen Editor and Logic Program software.

Screen creation guide	GP-PRO/PBIII for Windows (GPWMNL.pdf)	Operation Manual
		Tag Reference Manual
		Device/PLC Connection Manual
		Parts List
		Screen Layout Sheets
Logic programming guide	Pro-Control Editor (PCEMNL.pdf)	User Manual
		Operation Manual
		LT Type H I/O Setting User Manual



**Note:** PDF manuals can be viewed using Adobe® Acrobat® Reader. For Reader installation instructions, **Reference** *Setup Guide*.

**1.4.3 Connecting to the Home Page**

The procedure to connect to Pro-face's home page is described here.



- **To view Pro-face's home page, you must have the hardware necessary to access the Internet. You also must have a browser to view the home page, and subscribe to an Internet provider.**
- **Please understand that Pro-face cannot respond to any questions about your Internet connection.**

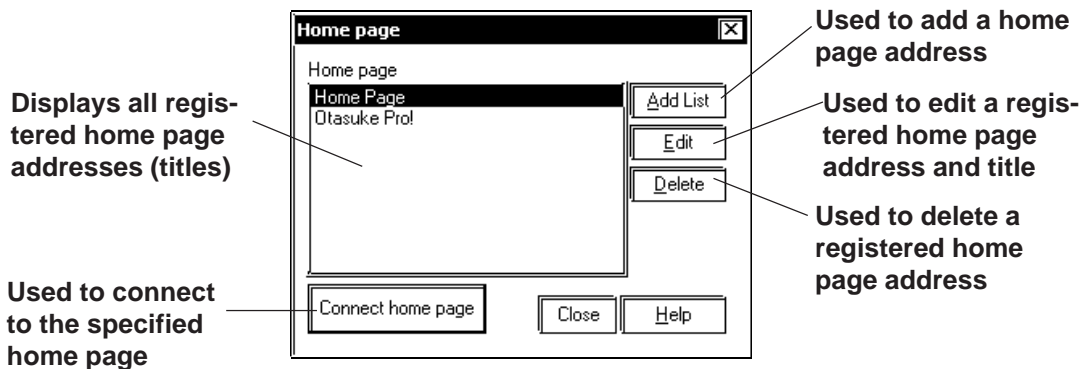
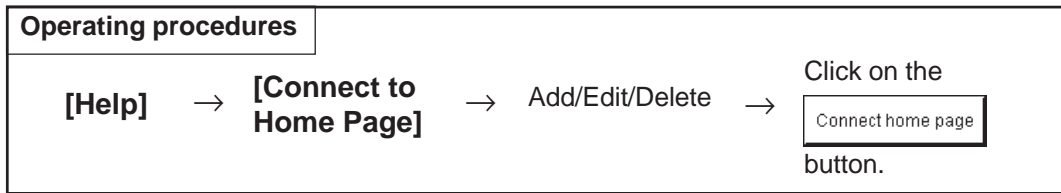

■ **Registering a Home Page Address**

The address of Pro-face's Web Page has been preregistered in your GP-PRO/PBIII for Windows software. When you click on the **Add List** button, the address setting dialog box appears.

**Reference** ■ *How To Register a Home Page Address*

■ **Deleting a Home Page Address**

Any registered home page address can be deleted. When you select the home page address to be deleted and click on the **Delete** button, the confirmation dialog box appears. If you click on the **OK** button, the selected home page address will be deleted. If you click on the **Cancel** button, the deleting operation will be canceled.



**■Editing a Home Page Address**

The registered home page address or title can be changed. When you select the home page address to be edited and click on the  button, the address setting dialog box appears (same as for the home page addition procedure), enabling you to change the title and address of the home page. If Digital Electronics Corporation’s home page address is changed in the future, please edit the currently registered address.

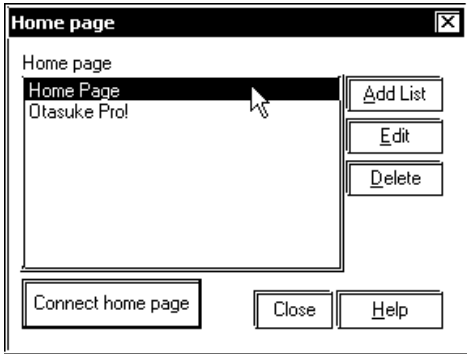
**■Connecting to the Home Page**

PROCEDURE	REMARKS
<p>(1) Select the [Help] menu - [Connect to Home Page] command in the Project Manager.</p> <p>(2) Select the target home page address.</p>  <p>(3) Click on the <input type="button" value="Connect home page"/> button to connect to Pro-face’s home page.</p> <p>The browser is started, and you will be connected to the home page.</p>	

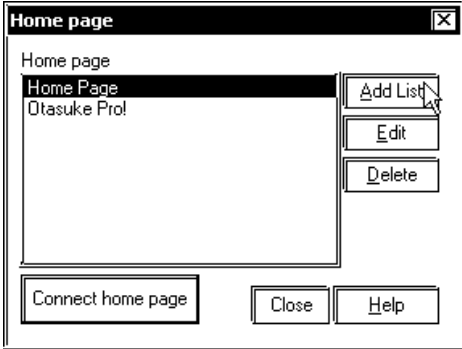
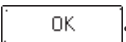
**How To Register a Home Page Address**

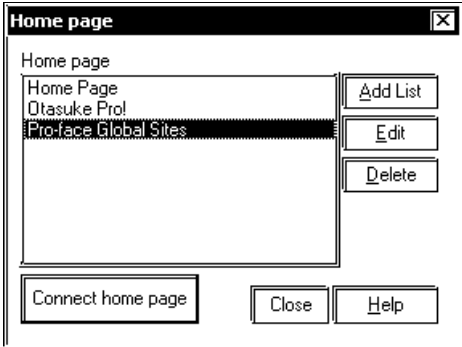
PROCEDURE	REMARKS
<p>(1) Select the [Help] menu - [Connect to Home Page] command in the Project Manager.</p> <p>(2) Click on the  button.</p>  <p>(3) Enter a home page title and address to be registered and click on .</p> <p>The specified home page address will be registered.</p>  <p style="text-align: center;">↓</p> 	

**1.4.4** Using “Otasuke Pro!”

“Otasuke Pro!” is the Pro-face’s support-dial site designed especially to meet customer support needs.

You can easily connect to the “Otasuke Pro!” site via the C-Package03 menu.



- **To view Pro-face’s home page, you must have the hardware necessary to access the Internet. You also must have a browser to view the home page, and subscribe to an Internet provider.**
- **Please understand that Pro-face cannot respond to any questions about your Internet connection.**

Usage Pattern
[Help] → Otasuke Pro! (O)

# *Memo*

**T**o create Base screens, the Editor area's Part, Draw, Tag, and Menu Bar commands can all be used. Also, Edit commands can be used to modify any Parts, objects or Tags that you have created. In addition to editing these screen objects, the procedures for registering Library Items and Windows are also explained.

2.1	.....	<b>Parts</b>
2.2	.....	<b>Drawing</b>
2.3	.....	<b>Tags</b>
2.4	.....	<b>Object Editing</b>
2.5	.....	<b>Libraries</b>
2.6	.....	<b>D-Script/Global D-Script</b>
2.7	.....	<b>Extended SIO Script</b>
2.8	.....	<b>Data Sampling</b>
2.9	.....	<b>Global Interlock</b>
2.10	.....	<b>Efficient Drawing Techniques</b>
2.11	.....	<b>Creating Handy-type GP Screen</b>
2.12	.....	<b>Creating ST Series Screen</b>
2.13	.....	<b>DXF Conversion</b>

## 2.1 Parts







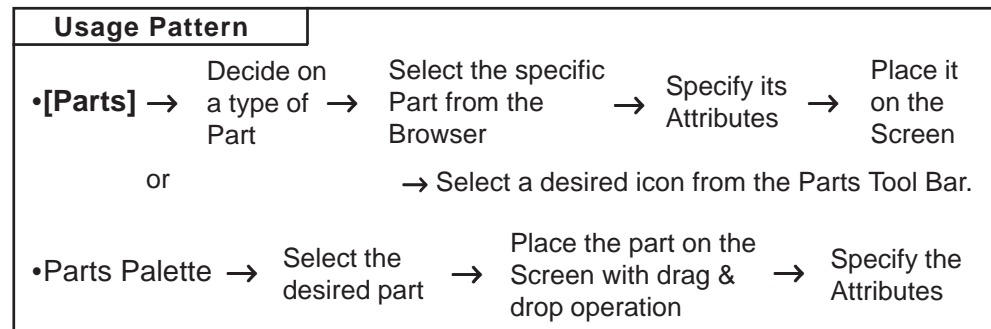



Each Part's attributes such as setting Addresses and colors will be designated via the dialog box. After designating all the necessary Part attributes, decide their position and size on the object drawing area.

Parts can be placed on the drawing screen simply by selecting the desired part from the palette and placing it on the screen with drag & drop operation.















The [Parts] command is enabled only on the Base screens.





### ■GP-PRO/PBIII for Windows Part Type List

Icon	Name	Function	Reference
	<b>Bit Switch</b>	Used to change a device's Bit Address data.	2.1.1 Bit Switches
	<b>Word Switch</b>	Changes a device's Word Address data.	2.1.2 Word Switches
	<b>Function Switch</b>	Used to go back to the previous screen, to switch screens, and to reset the GP.	2.1.3 Function Switches
	<b>Toggle Switch</b>	Turns the device's Bit Address ON or OFF.	2.1.4 Toggle Switches
	<b>Lamp</b>	Turns ON or OFF according to the device's Monitor Bit.	2.1.5 Lamps
	<b>4-State Lamp</b>	Switches the 4 states of the lamp, according to whether the device's two Monitor Bits are ON or OFF.	2.1.6 4-State Lamp
	<b>Bar Graph</b>	Displays the device's Word Address data in a bar graph.	2.1.7 Bar Graphs
	<b>Pie Graph</b>	Displays the device's Word Address data in a pie graph.	2.1.8 Pie Graphs
	<b>Half Pie Graph</b>	Displays the device's Word Address data in a Half-Pie graph.	2.1.9 Half Pie Graphs
	<b>Tank Graph</b>	Displays the device's Word Address data as absolute values in a Tank graph.	2.1.10 Tank Graphs



Icon	Name	Function	Reference
	<b>Meter</b>	Displays the device's Word Address data a Meter.	2.1.11 Meter Graphs
	<b>Trend Graph</b>	Displays the device's Word Address data as absolute values in a trend graph.	2.1.12 Trend Graphs
	<b>Keypad</b>	Used to enter a device's Word Address data.	2.1.13 Keypads
	<b>Keypad Input Display</b>	Displays data input via the keypad.	2.1.14 Keypad Display
	<b>Alarm Display</b>	When monitored Bits are turned ON, a list of "Basic" Alarm summary messages appear that have been previously registered in the Alarm Editor.	2.1.15 Alarm Display
	<b>Filing Data Display</b>	Displays data registered in the Filing Data list by specifying the corresponding file number.	2.1.16 File Name Display
	<b>Logging Display</b>	Displays device data loaded in the data logging settings by specifying the address for the corresponding block number.	2.1.17 Data Logging Display
	<b>Data Transfer Display</b>	Enables manual transfer of the data-transferring CSV data (ZR*****.CSV) from the CF Card to the device, or from the PLC to the CF Card.	2.1.18 Data Transfer Display
	<b>CSV Display</b>	Enables the display, editing and printing of the CSV file on the CF Card. Place and use this Display together with the Data Transfer Display or File Manager Display.	2.1.19 CSV Display
	<b>File Manager Display</b>	Displays the folders/files of the CSV files on the CF Card.	2.1.20 File Manager Display
	<b>Numeric Display</b>	Displays the device's Word Address numeric data as an absolute value.	2.1.21 Numeric Displays
	<b>Message Display</b>	Displays a previously registered message, according to device Word Address data changes. A maximum of 16 messages can be displayed in a single Message Display.	2.1.22 Message Display
	<b>Date Display</b>	Displays the current date, using the GP's internal calendar.	2.1.23 Date Displays
	<b>Time Display</b>	Displays the current time, using the GP's internal clock.	2.1.24 Time Displays

Icon	Name	Function	Reference
	Picture Display	Displays a single registered Library image (only graphic data), according to device Word Address data changes.	2.1.25 Picture Displays
	Window Parts	Windows created on the Window Screen (U) can be called up on the Base Screen (B).	2.1.26 Window Parts

### ■ Entering a Comment

If desired, a comment can be entered for a Part.

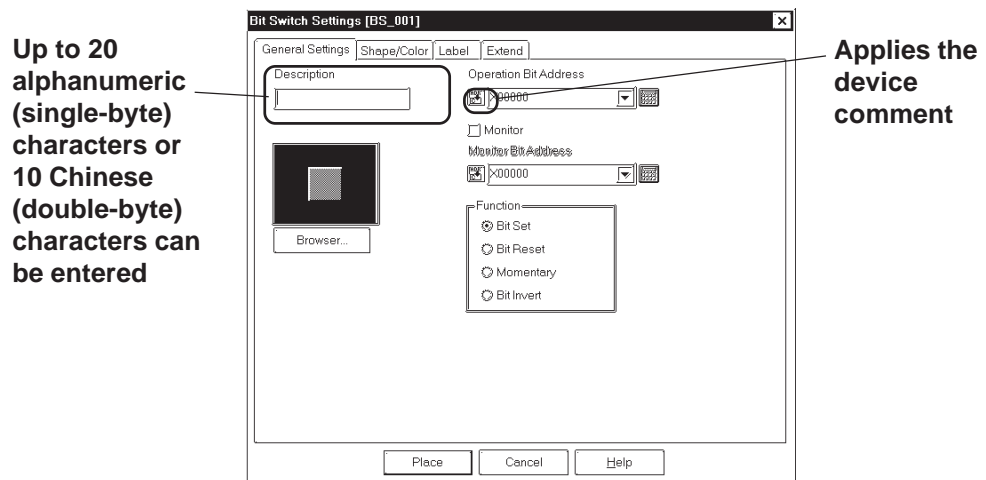

### ◆ Reflection of a Device Comment

If you click on the  [Apply Device Comment] button after entering an address, the device comment entered using the Symbol Editor is automatically searched for, and the comment corresponding to the entered device appears in the Description field.

**Reference**  4.9 *Symbol Editor*

## ■ Entering Addresses

Here, Addresses that are operated for Parts' functions and that are monitored are designated. A variable to be used in a logic program (GLC symbol) can be designated as a Part's address. **Reference** 4.2.6 *Symbol Editor*



**When a variable (GLC symbol) is used as an address, an integer array must be designated. For an integer array, the size used for consecutive addresses needs to be allocated. If the space (addresses) needed for the continuous addresses' array is not reserved/set up, the Part/feature will not operate correctly. Also, be aware that during Online Edit, the addition and deletion of variables may not operate correctly.**

Enter the address data here



**The address to be entered varies depending on your GP and external device types. Please understand that the sample configuration in this manual is only an example.**

## ◆ Entering from a keyboard

Click on the address entering field, and the cursor will appear there, which indicates data entry is now effective. Then, enter device and address data via the keyboard.

◆ Entering from an address keypad

Click on the address keypad icon, and the address keypad will appear, allowing you to enter numeric data and addresses on the screen via the mouse.

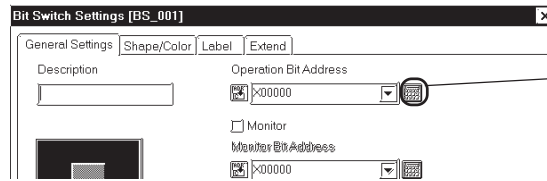

Activates the address keypad.

To move the address keypad to the desired position, drag its title bar.

To display the device names in a list, click here.

Backspace key

Hexadecimal number entry key

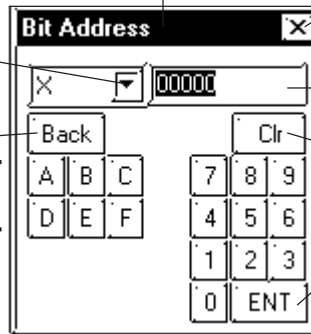

To close the address keypad, click here.

Display

Clear key

Enter key



- To prevent mistakes, be sure to double-check the address you are entering in the address keypad.
- When using a GLC/LT Series unit, you can designate logic program variables (GLC symbols) using bits. Click on the Address Keypad (shown above) and then on the [GLC] key to display the GLC Symbol Keypad to enter Address data.

[GLC Symbol Keypad]

Designates GLC symbols by using bits

Returns to the Address Keypad

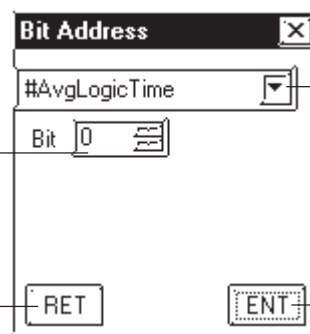

A pull down list shows GLC symbols.

The GLC symbol will be accepted with a click on the Enter key.

◆ Entering from a pull-down list

Click on the  box next to the Address entering field, and a pull-down list appears including symbols selected via the Symbol Editor and device comments together with corresponding Addresses. Selecting a symbol or device comment from the list designates an Address.

▼ **Reference** ▲ 4.7 *Symbol Editor*

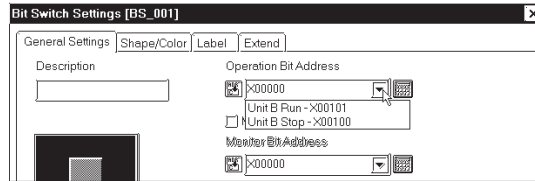

**Note:** A Part's specified address can be entered so that it is displayed during Base screen creation.

▼ **Reference** ▲ 2.10.2 *Screen Property Settings*

Regardless of whether addresses are designated as either displayed or not displayed during Base screen creation, they will not be displayed on the GP panel after screen transfer.

■ Selecting a Part Shape

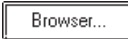
Click on the General Settings Area's  button in the dialog box, and the Shape Browser (hereafter called "Browser") will be displayed. The Browser's Part Shapes are stored in a Part File (PDB file or BPD file), separate from the main Project File (PRW file). Searching through different pre-made Part files allows you to easily find useful Part Shapes for almost any application.



**Note:** Parts (image parts) stored in BPD file is corresponding to GP2000 series only.

Click on a Part number and then the  button, or double-click directly on the Part number to select a Part Shape. (Browser disappears)



**Note:** Part File and Part Shape lists for each file are included in the GP-PRO/PBIII for Windows Parts List Manual.

Shows the Part name of the currently open Part Palette

The ID number of the Part Shape is displayed here. Reverse video (highlighting) indicates it is selected

Shows the ID number of the currently selected Part Shape

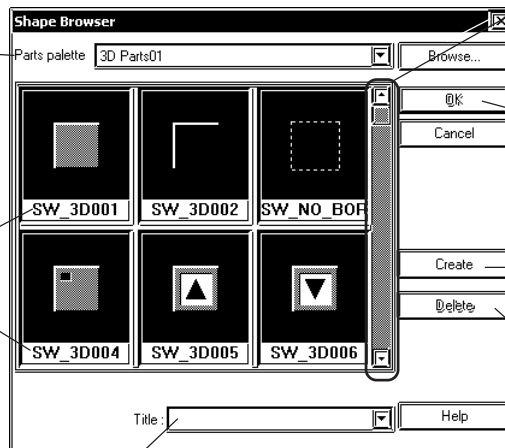

Clicking here scrolls through the Part Palette in this file

Calls up a list of the other Part files

Click here to register custom image parts.

Deletes custom image parts created by the user.

◆ **Browse**

Allows you to view and select the Parts files.

Two types of part files can be used: PDB files and BPD files.

Select the parts best suited to your application from the applicable files.



• Use the parts included in BPD files (image parts) for switches and lamps. However, these parts cannot be used for Toggle Switches or 4-State Lamp settings.

• The Image Parts feature is supported only by the GP2000 Series.

Click on the  button and a list of the Part files will appear. After clicking on a Part File, the information displayed will change to reflect that file. Next, click on the  button and the selected Part file's Part Shape will appear in the Browser.



- The BPD file is located in the [PDB] folder.
- Part files (PDB File/BPD File) are automatically installed in a folder named "PDB" when GP-PRO/PB III is first installed. If desired, these files can be installed in other folders instead. To display part shapes located in other folders, use the [Look in:] area to switch to the applicable folder.

<Differences between the PDB File and BPD File>

	Preprogrammed File	Registration/ Deletion by Users	Color Setting Adjustment
PDB	○	X	○
BPD	○	○*1	X

\*1: A preprogrammed BPD File cannot be registered or deleted.

◆ Registering Image Parts

Image files in bitmap file format and JPEG file format can be registered in the BPD File as Image Parts for switches and lamps (except for Toggle Switches and 4-State Lamps). Image files can be specified separately as either ON and OFF.

Click the **Create** button in the Shape Browser dialog box. The dialog box for registering Image Parts will appear.

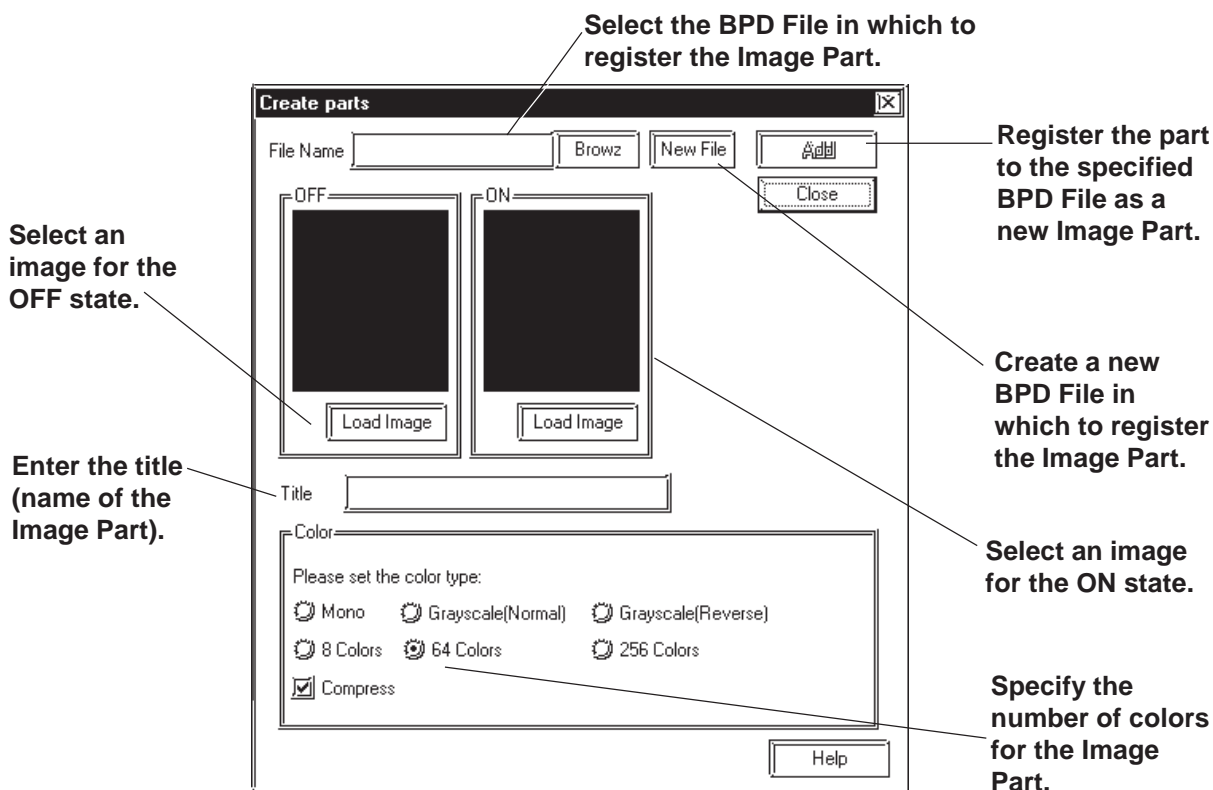



The following table shows the types of image files that can be registered.

Number of colors	1 bit		4 bits		8 bits		16-bit color	24-bit color	32-bit color
	2 colors (black & white)	16 colors	16-level gray scale	256 color	256-level gray scale				
Windows BMP/DIB	<input type="radio"/>	<input type="radio"/>	<input type="radio"/>	<input type="radio"/>	<input type="radio"/>	<input type="radio"/>	<input type="radio"/>	<input type="radio"/>	<input type="radio"/>
Windows BMP/DIB(RLE4)	-	<input type="radio"/>	<input type="radio"/>	-	-	-	-	-	-
Windows BMP/DIB (RLE8)	-	-	-	<input type="radio"/>	<input type="radio"/>	-	-	-	-
JPEG	-	-	-	-	<input type="radio"/>	-	-	<input type="radio"/>	-



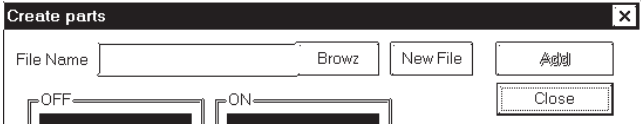
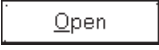

- Image Parts can be registered to a maximum size of 160 x 160 (dots).
- Image Parts will increase the size of the Project file. We recommend enabling the "Compress" setting in "Color" settings.
- Up to 200 Image Parts can be registered in a single BPD File.
- Before registering the Image Part, select image files for both ON and OFF states.
- When the sizes of the images for the ON and OFF states differ, the smaller image is magnified to equal the size of the larger image.
- Image Parts that are zoomed in or zoomed out may appear slightly different on the GP screen than from the PC screen.

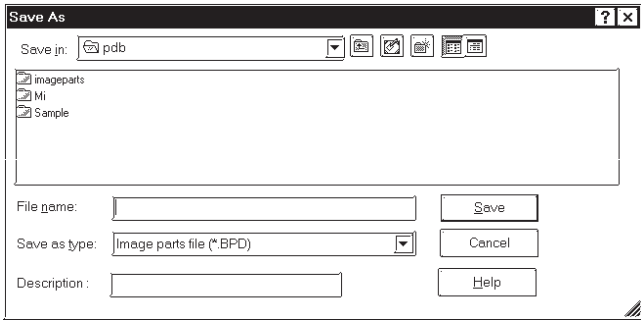
This section describes the procedure for registering Image Parts in the BPD File.

PROCEDURE	REMARKS
<p>(1) Click the  button in the Shape Browser dialog box.</p> <p>(2) Specify the location for registering the Image Part.</p> <p><b>[Register the Image Part in an existing BPD File.]</b></p> <p>a) Click the [Browz] button and select the BPD File in which to register the Image Part.</p>  <p>b) Press the  button to confirm the destination file for registering the Image Part.</p> <p><b>[Register the Image Part to a new BPD File.]</b></p> <p>a) Click the  button.</p> 	

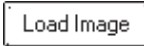
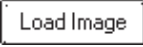
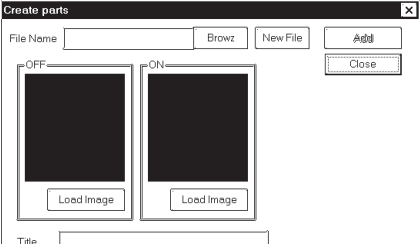
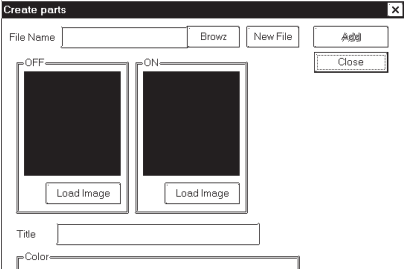

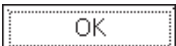
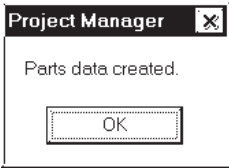
PROCEDURE	REMARKS
<p>b) <b>Specify the file name of the new file.</b>                      In the "File Name" area, enter the file name of the destination BPD File.</p> <p>In the "Description" area, enter the category name of the BPD File as well as any remarks that may be useful as notes.</p> <p>c) <b>Press the  button to confirm the destination file for registering the Image Part.</b></p> <p><b>(3) Select an Image Part for the OFF state. Click the  button and specify the desired bitmap image.</b></p>  <p><b>(4) Select an Image Part for the ON state using the procedure described in step (2).</b></p> <p><b>(5) In the "Title" area, enter the name of the Image Part.</b></p>  <p><b>(6) In the "Color" area, specify the display color for the Image Part.</b></p> <p><b>(7) Click the  button.</b></p> <p><b>(8) Click  to complete the registration.</b></p> 	<p>Image Parts can be registered to a maximum size of 160 x 160 (dots).</p> <p>Before registering the Image Part, select image files for both ON and OFF states.</p> <p>Image Parts will increase the size of the Project file. We recommend enabling the "Compress" in "Color".</p>

## ■ Selecting Colors

Specify Part colors using the Shape/Color setting screen. The setting items will differ depending on the Part, i.e. the border type, ON/OFF states, graphs, and label colors.

Tiling patterns can be selected for some of the Parts, Lamps, and Graphs.



**Specific colors are pre-assigned to each Image Part (BPD File) when it is selected from the browser. Color settings cannot be modified.**

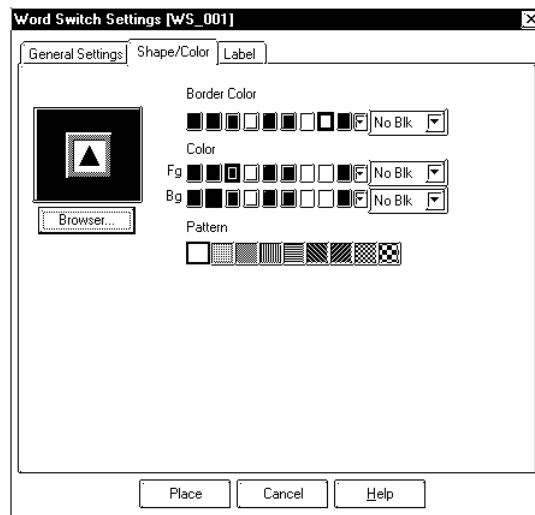

## ◆ Colors

Color setting methods will differ for each model, i.e. monochrome, monochrome LCD (eight levels of gray), 8-color, 64-color and 256-color settings.

64-color model : GP-571T, GP-675S, GP-675T, GP-377S, GP-377RT, GP-577RS, GP-577RT, GP2000 series (except GP-2301HL, GP-2300L, GP-2301L, GP-2500L and GP-2501L)

256-color model: GP2000 series (except GP-2301HL, GP-2301HS, GP-2300L, GP-2300S, GP-2301L, GP-2301S, GP-2500S and GP-2501S)

8-level gray-scale model: monochrome LCD GP2000 Series (GP-2301HL, GP-2300L, GP-2301L, GP-2500L and GP-2501L)



**important**

- **Do not transfer a Project File created using 64-color (256-color) data to a 64-color (256-color) incompatible GP panel. The 64-color (256-color) data may be automatically changed to monochrome data and some object elements, such as fills or patterns, may not be displayed as they were originally drawn.**
- **Pro-face recommends of using the basic 8 colors (on the color bar). Objects and image data created using colors (on the color palette) other than the basic 8 colors may flicker.**

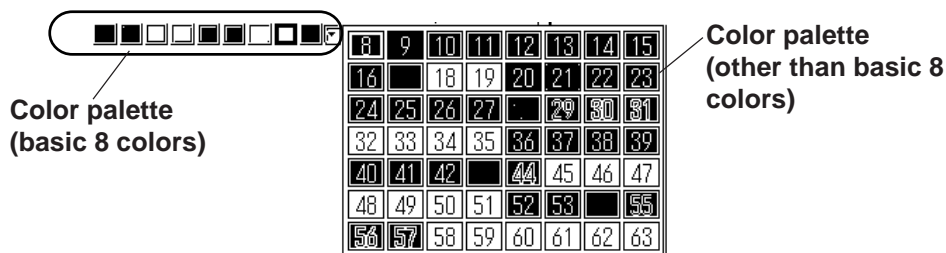

**<When using an 8-color or monochrome GP unit (incompatible with 64-color screens)>**

There are 8 colors available in the color bar. Use this bar to select the foreground (Fg), background (Bg) and other colors. When the [Reverse Display] option in the [GP Setup | I/O Settings] has not been checked, on a monochrome GP screen, black, blue, green, and cyan will be displayed as white (same as background); red, magenta, yellow, and white will be displayed as black.

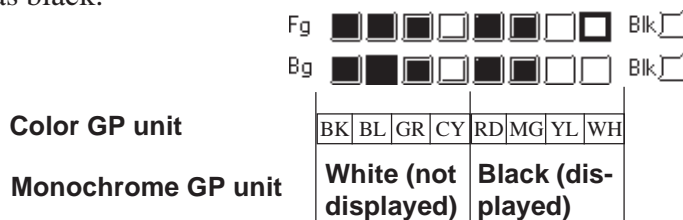

If the screen editor's [GP Setup] screen's [Initial Screen Settings] [Monochrome - 8 hues] is selected (enabled), the color can be set via the 8-color color bar. However, on the GP unit the display will be converted back to monochrome.

**<When using Monochrome LCD (eight levels of gray) GP unit >**

When the [Reverse Display] option in the [GP Setup | I/O Settings] has not been checked,

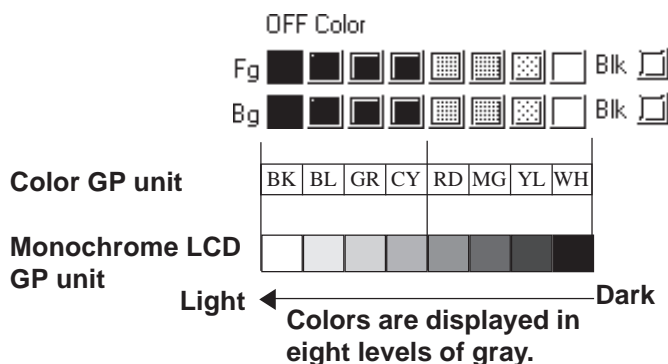

Depending on the color used, selecting MONOCHROME 8 HUES may cause the GP unit's screen to flicker. Confirm the color before using this mode.

<When using a 64-color GP unit>

There are 64 colors available via the color palette. Use the palette bar to select the foreground (Fg), background (Bg) and other colors.

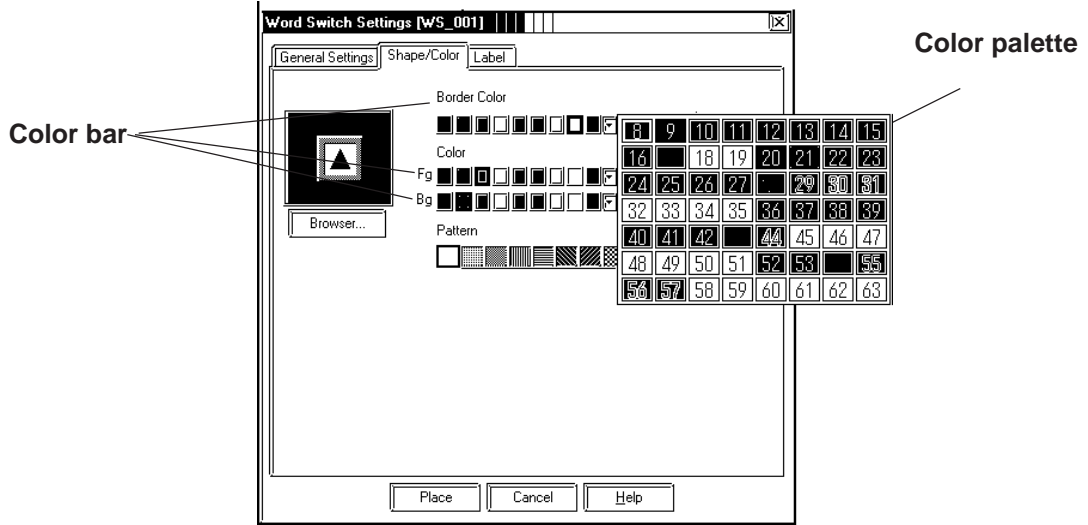

After converting 64 color data to 8 color data, each color will be displayed like this:

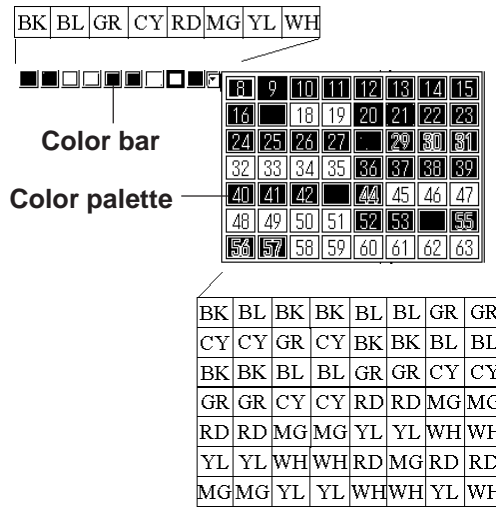

After converting 64 color data to monochrome data, each color will be displayed like this:

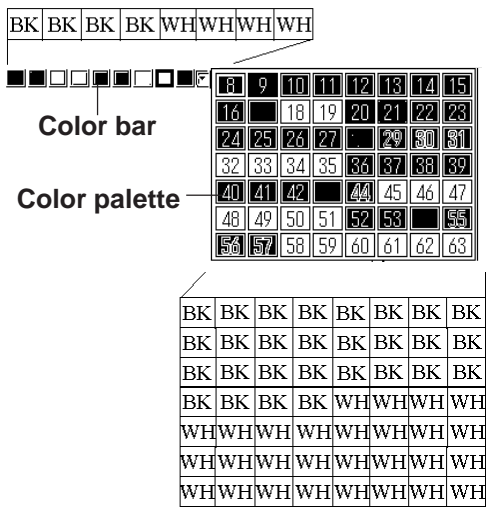

<When using a 256-color GP2000 series unit>

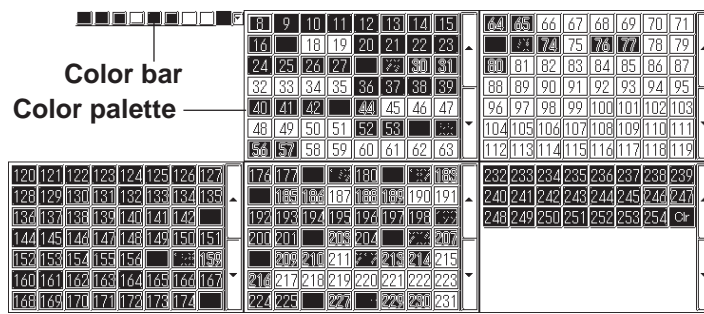

The following tables describe the changes in the display when the GP type is changed from a 64-color model to a 256-color model.

**64-color No blink**

0	1	2	3	4	5	6	7
8	9	10	11	12	13	14	15
16	17	18	19	20	21	22	23
24	25	26	27	28	29	30	31
32	33	34	35	36	37	38	39
40	41	42	43	44	45	46	47
48	49	50	51	52	53	54	55
56	57	58	59	60	61	62	63

0	1	2	3	4	5	6	7
8	9	10	11	12	13	14	15
16	17	18	19	20	21	22	23
24	25	26	27	28	29	30	31
32	33	34	35	36	37	38	39
40	41	42	43	44	45	46	47
48	49	50	51	52	53	54	55
56	57	58	59	60	61	62	63

**64-color Blink**

0	1	2	3	4	5	6	7
8	9	10	11	12	13	14	15
16	17	18	19	20	21	22	23
24	25	26	27	28	29	30	31
32	33	34	35	36	37	38	39
40	41	42	43	44	45	46	47
48	49	50	51	52	53	54	55
56	57	58	59	60	61	62	63

255	250	72	75	140	143	100	103
248	249	160	161	162	163	192	193
194	195	73	74	120	121	122	123
168	169	170	171	200	201	202	203
80	81	82	83	132	133	134	135
180	181	182	183	212	213	214	215
92	93	94	95	141	142	188	189
190	191	220	221	222	223	101	102

**64-color Fast**

0	1	2	3	4	5	6	7
8	9	10	11	12	13	14	15
16	17	18	19	20	21	22	23
24	25	26	27	28	29	30	31
32	33	34	35	36	37	38	39
40	41	42	43	44	45	46	47
48	49	50	51	52	53	54	55
56	57	58	59	60	61	62	63

232	235	104	107	244	247	116	119
233	234	144	145	146	147	224	225
226	227	105	106	236	237	238	239
148	149	150	151	228	229	230	231
108	109	110	111	240	241	242	243
152	153	154	155	64	65	66	67
112	113	114	115	245	246	156	157
158	159	68	69	70	71	117	118

**64-color Slow**

0	1	2	3	4	5	6	7
8	9	10	11	12	13	14	15
16	17	18	19	20	21	22	23
24	25	26	27	28	29	30	31
32	33	34	35	36	37	38	39
40	41	42	43	44	45	46	47
48	49	50	51	52	53	54	55
56	57	58	59	60	61	62	63

251	254	76	79	136	139	96	99
252	253	164	165	166	167	196	197
198	199	77	78	124	125	126	127
172	173	174	175	204	205	206	207
84	85	86	87	128	129	130	131
176	177	178	179	208	209	210	211
88	89	90	91	137	138	184	185
186	187	216	217	218	219	97	98

◆ **Blink**

Blink settings will also differ slightly depending on whether a single speed Blink GP model or a three speed Blink GP model is used. Digital's three speed blink models are the GP-571T, GP-675S, GP-675T, GP-377S, GP-377RT, GP-577RS, GP-577RT and GP2000 series units (except GP-2301HL, GP-2300L, GP-2301L, GP-2500L and GP-2501L). Other GP models have only one blinking speed. When 256-colors are selected in a project, the "Blink" feature cannot be used for any of that project's screens.

<Using a three speed Blink type GP>

Next to the Check Box, there is a Button that will display a range of 3 speeds and "No Blk" (indicates no blinking). When one of the blink speeds is selected, the color bar is displayed in a darker color and the specified Part will blink on the GP screen.

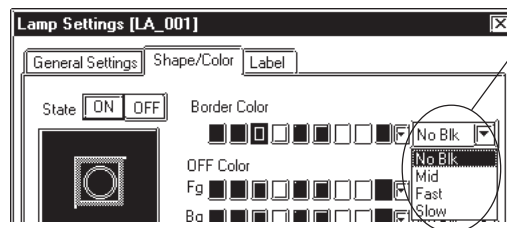

**Blink speed settings**

The normal blink speed is "Mid." "Fast" is twice as fast as "Mid" and "Slow" is half as fast as "Mid". When "No Blk" is selected, the Part will not blink.

<Using a single speed Blink type GP>

When the Blink (Blk) Check Box is checked , the color bar is displayed in a darker color and the specified Part will blink on the GP's screen. With monochrome (eight layers of gray), the color bar on the GP-PRO/PBIII screen will be displayed in dark blue color. (black color blink is excluded)



**Blink Check Box**

When the GP model is changed from a three speed Blink type to a single speed type, the "Mid" and "Slow" speeds will be changed to the single speed GP's "Blink" speed, and "No Blk" and "Fast" will be changed to "No Blk". The blinking rate for a single speed GP model is equal to the "Mid" setting of the three speed type.

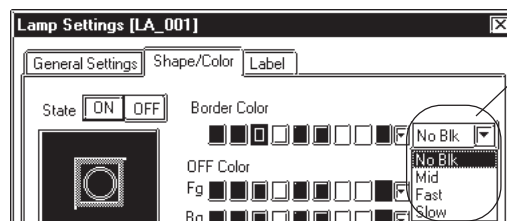

No Blk	No blink
Mid	Blink
Fast	No blink
Slow	Blink



**Transparent mode can be selected as the background color (Bg) text and Mark objects. This function is useful when overlaying text on Switches, Lamps, and other objects.**

**For example: Change the background color of the label from "Black" to "Transparent".**

Label

Switch →

The background color of the label is black.

The background color of the label becomes transparent.

<All models>

Bg [Color Bar] Blk

Specify the background color of the label as "Black" only.

<Non-256-color models>

Bg [Color Bar] Blk

Specify the background color of the labels as "Black and Blk (Blink)".

\*On 64-color models, this feature is enabled only when the "Mid" blink speed is selected.

<256-color models>

Specify the background color of the labels as "Clr".

232	233	234	235	236	237	238	239
240	241	242	243	244	245	246	247
248	249	250	251	252	253	254	Clr

◆ States

Only Parts which can have two states are displayed with this feature. Display colors for Parts can be specified separately for each state; for example, a Bit Switch can be displayed as red in the OFF state and green in the ON state. Click on either state button to select it, and specify that state's color using the color bar.

■ Alarm Settings

In both graph and numeric value displays, Alarms can be set up. First, click on the [Alarm Settings] tab at the top of the Dialog box. When checking the Alarm Display box (Check mark  appears), the Alarm setting items will appear.

Bar Graph Settings [BA\_001]

General Settings | Graph Settings | Shape/Color | Alarm Settings

Alarm Display

Alarm Range

Min. Value: 0

Max. Value: 100

Alarm Type

Direct

Indirect

Alarm Color

Fg [Color Bar] No Blk

Bg [Color Bar] No Blk

Place Cancel Help

Sets the Alarm value's Format to fixed or variable

Sets the minimum and maximum Alarm values

Sets the Alarm colors used

◆ Alarm Type

The Alarm value can be specified as either direct (fixed value) or indirect (variable value) by simply clicking on the appropriate circle.

◆ Alarm Range

Here, you can specify the maximum and minimum Alarm values.

When the Alarm value has been specified as indirect, the maximum and minimum values can also be specified as indirect. In this case, the Word Address number used to store these values will be automatically assigned continuously from the Word Address currently specified.

The following example uses “n” to denote where the Word Address’ display data is stored:

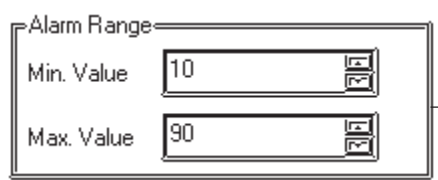

Word Addresses are automatically allocated in sequence, starting from the Address designated

<Relationship between display data’s storage address and Alarm register address>

With 16 Bit data

n	Display Data
n+1	Data value - Max.
n+2	Data value - Min.

With 32 Bit data

n	Display Data
n+1	
n+2	Data value - Max.
n+3	
n+4	Data value - Min.
n+5	



*When a variable (GLC symbol) is used as an address, an integer array must be designated. For an integer array, the space required for consecutive addresses must be allocated. If the space (addresses) needed for the continuous addresses' array is not reserved/set up, the Part/feature will not operate correctly.*

*Also, be aware that during Online Edit, the addition and deletion of variables may not operate correctly.*

◆ Alarm Color

Here, you can select the colors used for an Alarm display.

▼ **Reference** ▲ 2.1 Parts ■ *Selecting Colors*



■ **Creating Labels**

Here, a Label means the text characters shown on the faces of the Switch and Lamp button Parts. Labels can be registered via the Part's Setting dialog box.



As with Parts, Label display colors can be created for each of a 2-state Part's states; up to 4 lines of text can be used for each state.

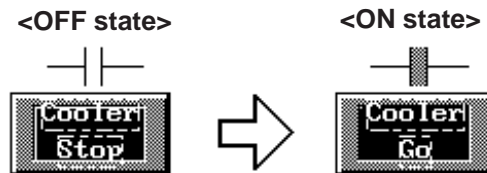

When a lamp's Text Display changes  
(This Switch's ON/OFF colors are also selected)



**Note:** The Part must be large enough to display the entire Label.

**Select the text type.**

**Enter characters to be displayed as direct text.**

**Copies the characters from the Description field to the label of the current state.**

**Copies the characters to the label for the Off state.**

**Moves the label back to the center that has been repositioned after placing the part.**

**Select the label's color here.**

**If using the direct text as Image Font, place a check mark in the check box.**

**Select the character's size.**

**Select the character's type.**

◆ **Direct Text**

The text entered in the text entry field is placed directly as a fixed text string.

◆ **Browse Text Table**

You can select or add strings previously registered via the Text Table Editor.

▼ **Reference** 4.6.3 ■ **Selecting the text table character string** ◆ **Entering the text table character string**

◆ **Image fonts**

Windows fonts are displayed in bitmap format.

This feature is enabled only when the "direct text" mode is selected.

▼ **Reference** 2.2.9 **Text** ◆ **Image Font**

**Note:** The Image Font is supported only by the GP2000 series.

#### ◆ Label

Here, you can type in the text displayed on a button. When typing in text, press the  key to move to a new line. When the [Tracking] check box is checked  (enabled), after the Part has been placed on the screen, if the Label's size or position is changed, for either state, the alternate state's Label size and position will be also automatically changed. If, however, the Label's size and position need to be specified independently for each state, DO NOT check  this box. **Reference** 2.4.3 *Scaling Up/Down*

#### ◆ Copy from Description

The characters entered in the Description filed are copied to the label in the selected state.

#### ◆ Copy to Off (On) state

When the state is On, the characters entered in the label are copied to the label in the Off state. When Off, the characters are copied to the label in the On state.

#### ◆ State

States are displayed only for Lamps, and for those switches with two states (ON and OFF). The text displayed for each state can be specified independently. Simply click on either state button to specify its text and colors.

#### ◆ Centering

Moves the label to the center of the part when the label has been repositioned after placing the part.

#### ◆ Character Size

Specifies the size of character.

**Reference** 2.2.9 *Text*

#### ◆ Style (Font)

Specifies the type of character (Normal, Bold, Raised) used in each Label.

**Reference** 2.2.9 *Text*

#### ◆ Text Color

Specifies Label colors.

The default settings are Fg: White, and Bg: Transparent mode (Black + Blk).

#### ◆ Alignment (Justification)

When the text input for a Label exceeds one line, the Alignment icons will appear. Select Left, or Right justification, or Centering.

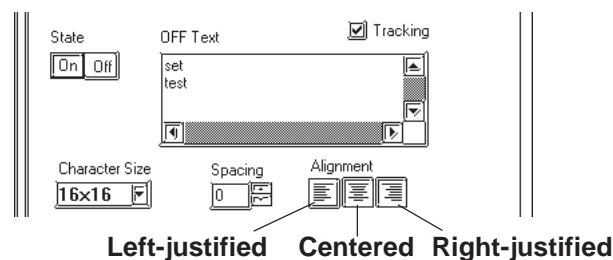

■ ID Numbers

When creating a Part, an ID number is automatically assigned to the Part before it is placed on the screen. This number shows how many of that kind of Part were previously placed on the current screen. When a Part is deleted from a screen, all following Part numbers will be adjusted downwards.

Example of an ID number

**BS \_ 010**

Indicates that this Part is a Bit Switch  
(Varies according to the Part)

Indicates the placement/  
creation order of the Part; in  
this case, it is the 10th.

The ID number is displayed in the title bar at the top of the Setting dialog box.

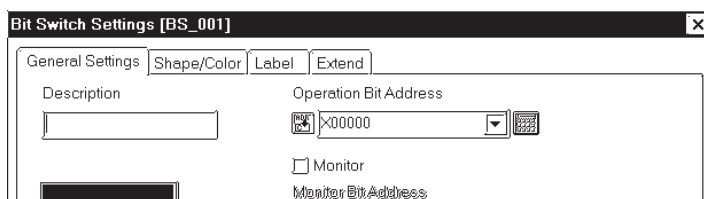

The ID number can be entered so that it is displayed during Base screen drawing. **Reference** 2.10.2 Screen Property Settings

Even if the ID number is entered to be displayed during Base screen drawing, it will not be displayed on the GP panel after screen data transfer.

<ID Number List>

Part Name	ID Number	Part Name	ID Number
Bit Switch	BS-**	Alarm Display	AL-***
Word Switch	WS-***	File Name Display	FD-***
Function Switch	FS-***	Data Logging Display	LG-***
Toggle Switch	TS-***	Data Transfer Display	DT-***
Lamp	LA-***	CSV Display	CS-***
4-state Lamp	LF-***	File Manager Display	FM-***
Bar Graph	BA-***	Numeric Display	ND-***
Pie Graph	PI-***	Message Display (Operation Mode: Bit)	MB-***
Half-Pie Graph	HP-***	Message Display (Operation Mode: Word)	MW-***
Tank Graph	SG-***	Date Display	DD-***
Meter	MT-***	Time Display	TD-***
Trend Graph	TR-***	Picture Display (Motion mode: Bit)	LB-***
Keypad	KE-***	Picture Display (Motion mode: Word)	LW-***
Keypad Input Display	KD-***	Window Parts	WI-***

■ **Maximum Number of Automatically Created Part Libraries**

When a Part is used in a project, a Part Library will be automatically created in preparation for data transfer. The number of Part Library items are limited to 6000 per project. If this number exceeds 6000, all Parts in excess of 6000 cannot be transferred to the GP. To avoid this, please remember the following:

1. Automatic Library creation will be performed follows: (per screen)
  - Switches: 2 (only switches with the Monitor function selected)
  - Lamps: 2
  - Messages: 2 to 16 (depending on the number of states used)
  - Picture Displays : 2 to 16 (depending on the number of states used)
  - Trends: 1 to 20 (depending on the number of channels)

However, Part Libraries using the same Parts (i.e. Part's that are the same size, same attributes, and without labels or other items) will be used commonly.

For example:

When 30 Switches (Monitor function is selected) and 20 Lamps are placed on a single Base screen,  $(30 \times 2) + (20 \times 2) = 100$  Part Library items will be automatically created. Therefore, 60 of these size screens can be used in one project('s data).

2. When using the same Parts for multiple Base screens, register the Part on one Base screen and then place it other Base screens using the Load Screen function. Thus, when multiple Base screens use those Parts, only one Part Library will be used, thereby reducing the Project File's size.

■ **Placing a Part in Position**

After all of a Part's attributes have been entered or selected, click on the desired position on the screen to place the Part.

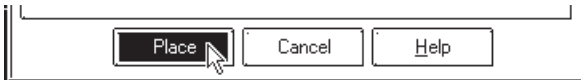
PROCEDURE	REMARKS
<p>(1)After all of a Part's attributes have been entered or selected, click on the <input type="button" value="Place"/> button.</p> <p>The Part's outline will appear on the Base screen, next to your cursor.</p> 	

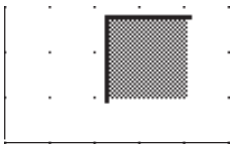
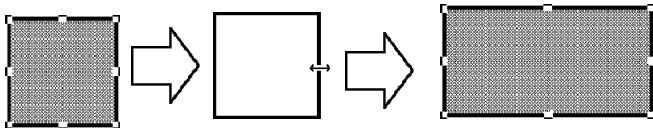
PROCEDURE	REMARKS
<p>(2)Click on the point where the Part's top left corner is to be placed. The selected Part will then appear on the screen.</p>  <p>(3)Adjust the Part's size, if desired. Click on the Part to select it, and drag any one of the handles to change the size of the Part. To change the size of a Part, move the cursor to a Part "handle" and click, then drag the "handle" to re-size the Part, and click again.</p> 	<p><b>Reference</b> 2.4.3 <i>Scaling Up/Down</i></p> <p>After placing the Part, double-clicking on it automatically brings up its Attribute Setting dialog box.</p> <p><b>Reference</b> 2.4.14 <i>Changing Attributes</i></p>



Depending on the Part, when scaling up or down, a one dot error may occur in the frame width.

E.g.)

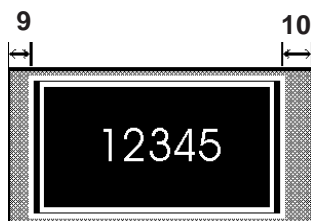

**Touch Panel Grid**

When placing Switch Parts and Keypad Input Display Parts (when the pop-up keypad is used), be sure to place them so they align with the Touch Panel's 20 x 20 dot grids. (See figure below.)

These 20 x 20 dot grids are the smallest units available for placing items on the Touch Panel. Be sure not to place 2 switches on a single grid, as pressing the point could activate both switches.

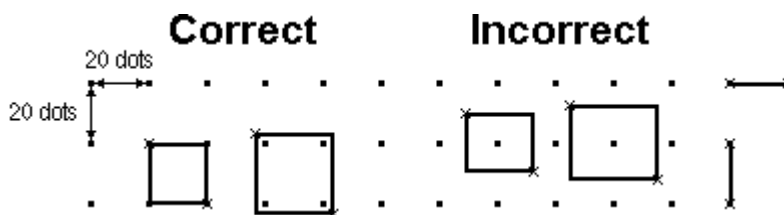

### 2.1.1 Bit Switches

Here, the creation of a touch panel switch, used for turning a specified Bit ON or OFF, is explained.



**If the GP unit has not been connected to the device, Bit Switches with the Monitor function selected will not be displayed on the GP unit after the Project File transferred.**

#### ■ Bit Switch [General Settings] Attributes

Enter comment data here

Image of the currently selected Part Shape

Calls up the Part Shape Browser where a different Part Shape can be selected

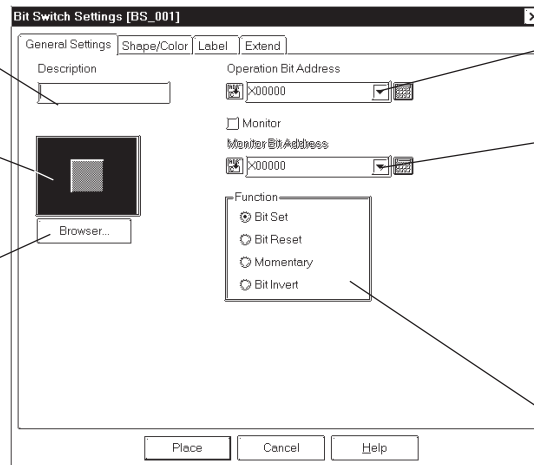

Enter the Bit Switch Address

When creating a Bit Switch with two states, check this box and enter the alternate Bit Switch Address below

Select the switch's function

#### ◆ Operation Bit Address

Here, the Bit Address data controlled by the Switch is input.

#### ◆ Monitor Bit Address

Only after the Monitor check box is checked can the Monitor Bit Address used to change the Switch's display setting be entered. The Switch's state (ON/OFF) display can be specified so that it will change according to changes in this Bit Address. Addresses input in the Bit Address area can also be done here.

Appears only when creating a Bit Switch with two states. Toggles the switch's state either ON or OFF, allowing you to set the attributes of each state

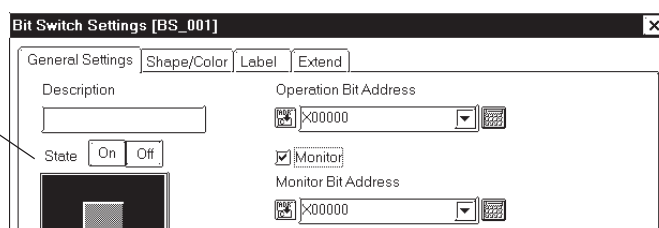

After entering the Bit Address, if you attempt to perform another area's operation before entering the Monitor Bit's address data, the dialog box shown below will appear. Clicking on the  button automatically inputs the Bit Address's data into the Monitor Bit Address. To enter a different address, click on the  button and input the desired address.



#### ◆ Function

The Bit Switch functions are as follows.

- Bit Set:** When the Bit Switch is pressed, the device's designated Bit Address is turned ON. This state continues (i.e. remains ON) even after the switch is released.
- Bit Reset:** When the Bit Switch is pressed, the device's designated Bit Address is turned OFF. This state continues (i.e. remains OFF) even after the switch is released.
- Momentary:** Only while the Bit Switch is pressed and held is the specified device Bit Address turned ON. Thus, when the switch is released, the specified Bit Address is turned OFF.
- Bit Invert:** Every time the Bit Switch is pressed, the device's designated Bit Address state is changed (from ON to OFF, or from OFF to ON).

#### ■ Bit Switch [Shape/Color] Attributes

Here, the Switch's border color (Frame), ON/OFF state colors (On Color, Off Color), and pattern can be selected.

##### ▼ Reference ▲ 2.1 Parts ■ Selecting Colors

The color and pattern settings available will differ depending on the switch's settings.

#### ■ Bit Switch [Label] Attributes

Here, the text of the Label to be displayed on the Switch button is entered.

##### ▼ Reference ▲ 2.1 Parts ■ Creating Labels

### ■ Bit Switch [Extend] Attributes

Set up the Interlock and Buzzer functions.

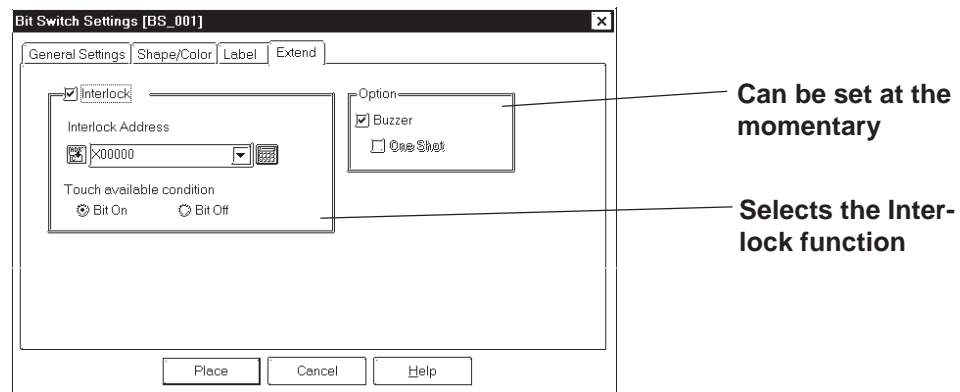

#### ◆ Interlock

Only when a bit designated via Interlock Address is in a state that has been selected via [Touch available condition], the switch becomes effective. Whether the switch is effective in ON state or in OFF state is selectable here.



**Note:**

The "Bit Off" feature is available only with the GP-377, GP77R and GP2000 series.

Touch Available Condition	Interlock Address Status	Touch Available/Not Available
Bit ON	ON	Touch Available
	OFF	Touch Not Available
Bit OFF	ON	Touch Not Available
	OFF	Touch Available

#### ◆ Buzzer

Select ON or OFF for the buzzer sound.

When buzzer setting is enabled, the buzzer sounds while the touch switch is being pressed.

#### ◆ One-Shot

Enable/disable the "One-Shot" feature.

This setting can be enabled only when "Momentary" mode is selected in the "Function" area in the "General Settings" tab. When the "One-Shot" feature is enabled, the buzzer will sound briefly only at the moment the touch switch is pressed.

**Reference** Tag Reference Manual, 2.23.4 One-Shot Buzzer for T-tag momentary



**Note:**

The "One-Shot" feature is available only with the GP-377, GP77R and GP2000 series.



■ **Placing a Bit Switch**

An example of how to place a Reverse Switch is shown below.

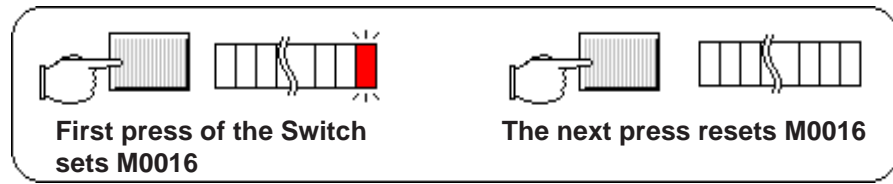

PROCEDURE	REMARKS
-----------	---------

(1) Select the [Parts] menu - [Bit Switch] command, or click on the icon.

(2) In the [General Settings] screen, input the Bit Address and select the Bit's Function.

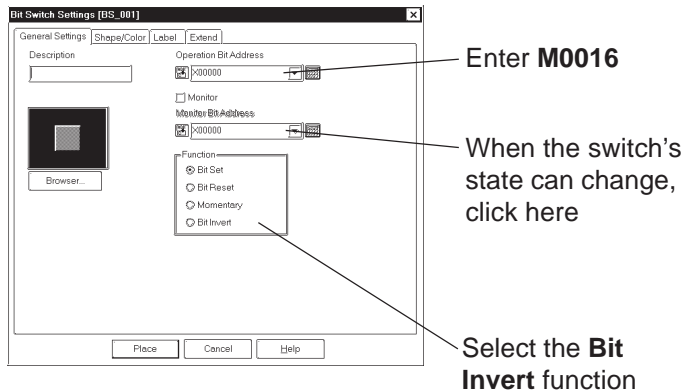

(3) Select a Part Shape from the Browser. Specify settings for Shape/Color, Label and Extension Settings if necessary.

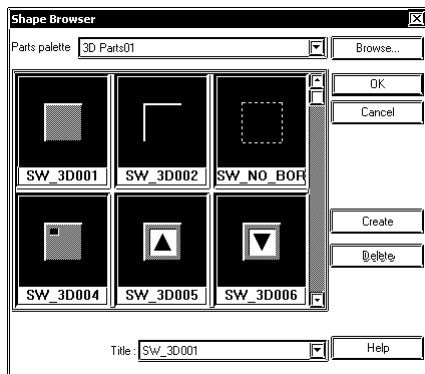

(4) After all of a Part's attributes have been entered or selected, click on the button.

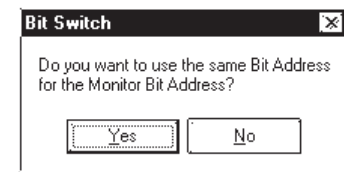

The Switch's outline will appear on the Base screen, next to your cursor.

When the Change State function selected, after entering the Bit Address, if you attempt to perform another area's operation before entering the Monitor Bit Address, the dialog box shown below will appear. Click on the button to input the same address as used for the Bit Address. To enter a different address, click on the button and input the desired address.

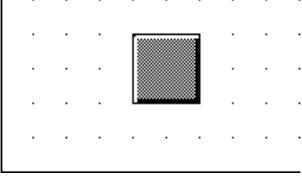

**Reference** 2.1 Parts ■ *Selecting a Part Shape*

Image Parts can be used with the GP2000 series.

PROCEDURE	REMARKS
<p>(5) Click on the point where the Switch's top left corner is to be placed.</p> <p>If desired, use the Switch's handles to alter its size.</p> 	<p>To cancel the placement, click on the  icon.</p> <p><b>Reference</b> To change the Part's size, refer to <b>2.4.3 Scaling Up/Down</b>.</p> <p>Double-clicking on any Part placed on the screen automatically calls up that Part's Attribute Setting dialog box.</p> <p><b>Reference</b> <b>2.4.14 Changing Attributes</b></p>

### 2.1.2 Word Switches

Here, a touch panel switch for setting data to a specified Word Address can be created.

#### ■ Word Switch [General Settings] Attributes

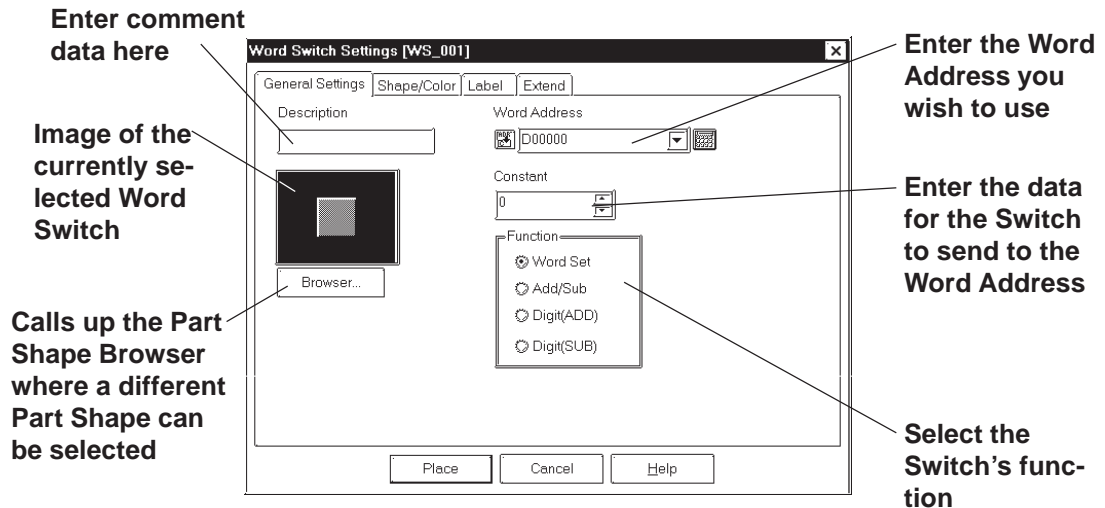

#### ◆ Word Address

Here, the desired Word Address is entered.

#### ◆ Constant

Here, number registered to the Word Address is input. The data format is Decimal (Base 10), and the input range is from -32768 to 32767.

#### ◆ Function

The Word Switch's functions are as follows:

- Word Set:** When the Word Switch is pressed, constant data is written to the device's designated Word Address. Fixed or default values will be written to the timer, counter, etc.
- Add/Sub:** Every time the Word Switch is pressed, the Data value is added to the data currently in the device's designated Word Address, and the result is then written to the Device's address. If a Data value is positive, the function will increment, and if it is negative, it will decrement.
- Digit (ADD):** Every time the Word Switch is pressed, the designated decimal place's data will be added by the Constant's value. The result will not be carried up to the next digit, so "9" simply rolls around to "0". Select the data format from Bin and BCD.
- Digit (SUB):** Every time the Word Switch is pressed, the designated decimal place's data will be subtracted by the Constant's value. The result will not be carried down to the lower digit, so "9" simply rolls around "0". Select the data format from Bin and BCD.

■ **Word Switch [Shape/Color] Attributes**

Here, a Word Switch’s color, and pattern can be selected.

▼ **Reference** ▲ 2.1 Parts ■ *Selecting Colors*

The color and pattern settings available will differ depending on the Switch’s settings, such as its shape and Change State condition.

■ **Word Switch [Label] Attributes**

Here, the text characters shown (engraved) on the Switch button face are input.

▼ **Reference** ▲ 2.1 Parts ■ *Creating Labels*

■ **Word Switch [Extend] Attributes**

Here, the interlock and the buzzer can be set as shown below.

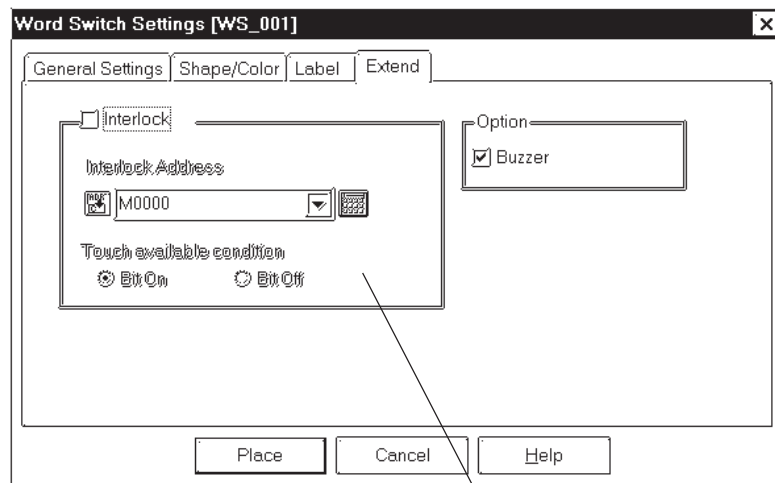

Select the Interlock function state

◆ **Interlock**

Only when a bit designated via Interlock Address is in a state that has been selected via [Touch available condition], the switch becomes effective. Whether the switch is effective in ON state or in OFF state is selectable here.



**Note:** The “Bit Off” feature is available only with the GP-377, GP77R and GP2000 series.

Touch Available Condition	Interlock Address Status	Touch Available/ Not Available
Bit ON	ON	Touch Available
	OFF	Touch Not Available
Bit OFF	ON	Touch Not Available
	OFF	Touch Available

◆ **Buzzer**

Sets the buzzer to ON/OFF

■ **Placing a Word Switch**

An example of how to place a Data Set Switch is shown below.

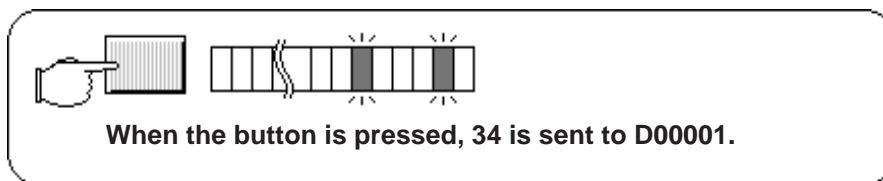

PROCEDURE	REMARKS
-----------	---------

(1) Select the [Parts] menu - [Word Switch] command, or click on the icon.

(2) In the [General Settings] area, input the Word Address and Constant data, and select a function.

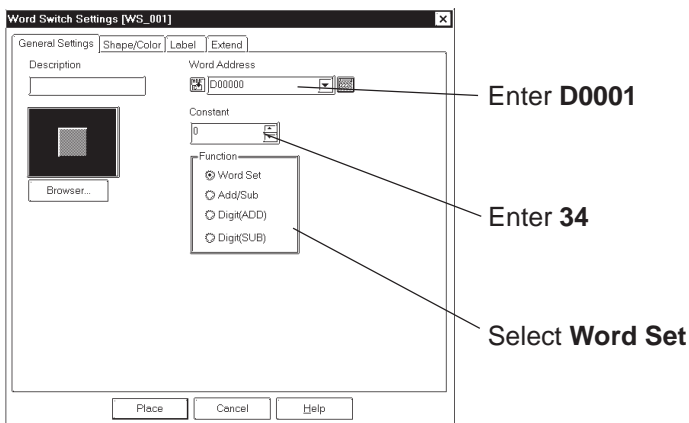

(3) Select a Part Shape from the Browser. Specify settings for Shape/Color, Label and Extension Settings if necessary.

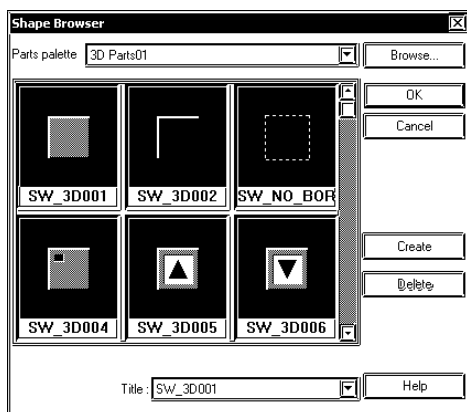



(4) After all of the Part's attributes have been entered or selected, click on the button.

The Switch's outline will appear on the Base screen, next to your cursor.

**Reference** 2.1 Parts ■ *Selecting a Part Shape*

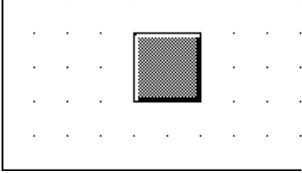
Image Parts can be used with the GP2000 series.

PROCEDURE	REMARKS
<p>(5) Click on the point where the Switch's top left corner is to be placed.</p> <p>If desired, use the Switch's handles to alter its size.</p> 	<p>To cancel the placement, click on the  icon.</p> <p><b>Reference</b> To change the Part's size, refer to <b>2.4.3 Scaling Up/Down</b></p> <p>Double-clicking on any Part placed on the screen automatically calls up that Part's attribute settings.</p> <p><b>Reference</b> <b>2.4.14 Changing Attributes</b></p>

### 2.1.3 Function Switches

Here, a touch panel with special functions can be created.

#### ■ Function Switch [General Settings] Attributes

The screenshot shows the 'Function Switch Settings [F5\_001]' dialog box. It has four tabs: 'General Settings', 'Shape/Color', 'Label', and 'Extend'. The 'General Settings' tab is active. It contains a 'Description' field, a 'Function' list with radio buttons, and a 'Go To Screen' field with a dropdown menu. The 'Go To Screen' field is set to '81' and 'BIN'. A 'Browser...' button is located below the 'Description' field. At the bottom are 'Place', 'Cancel', and 'Help' buttons.

Annotations on the left side:

- Enter comment data here (points to the Description field)
- Image of the currently selected Function Switch (points to the square icon in the Description field)
- Calls up the Part Shape Browser where a different Part Shape can be selected (points to the Browser... button)

Annotations on the right side:

- Select the Switch's operation (points to the 'Go To Screen' radio button)
- Shows the display screen's data type. (points to the 'BIN' dropdown)
- When "Go To Screen" is selected, the (Go To) screen's number and data format must be entered (points to the '81' and 'BIN' fields)

#### ◆ Function (Switch Operation)

The Function Switch's attributes are as follows:

##### Previous Screen:

When the Switch is pressed, the currently displayed screen on the GP will change to the previously displayed one.

##### Go To Screen:

When the Switch is pressed, the currently displayed screen on the GP will change to the specified screen. Input the screen number to be changed (jumped) to. The Data Format can be either Bin or BCD. The display screen's data type (BIN or BCD) is shown. The data type can be changed via the [GP Setup], [GP Settings] screen's [Screen Number Data Type].



**Note:** If a screen number is specified in the BCD data format to place the corresponding screen, it is still displayed in the BIN data format when the screen is closed and then opened.

##### Reset GP:

When the Switch is pressed, the GP will be reset to the save status as when the GP's power was turned ON.



**Resetting the GP/LT turns the I/O signal off. Be sure to consider this when designing your system.**

**File Name Key:** This is a function switch corresponding to the File Name Display and is the same as the one that is automatically placed together with the File Name Display. Designate the same ID number as the one of the File Name Display and select a operation mode.

**Reference** *2.1.16 File Name Display*

**Data Logging Key:** This is a function switch corresponding to the Data Logging Display and is the same as the one that is automatically placed together with the Data Logging Display. Designate the scroll direction and the number of lines being rolled up or down.

**Reference** *2.1.17 Data Logging Display*

**CSV Display Key:** This function switch corresponds to the CSV Display and is the same as the one automatically placed together with the CSV Display. This switch can be used only with GP2000 Series units. Designate the scroll direction, number of lines to be scrolled up or down, and the print area.

**Reference** *2.1.19 CSV Display*

**File Manager Display Key:** This function switch corresponds to the File Manager Display and is the same as the one automatically placed together with the File Manager Display. This switch can be used only with GP2000 Series units. Designate the switch on which the File manager Display is to be displayed.

**Reference** *2.1.20 File Manager Display*



**Data Transfer Key:**

This function switch corresponds to the Data Transfer Display and is the same as the one automatically placed together with the Data Transfer Display. This switch can be used only with GP2000 Series units. Designate the direction of the transmission, scroll direction, number of lines to be scrolled up or down, and the touch key on which the Data Transfer Display is to be displayed.

**▼Reference▲ 2.1.18 Data Transfer Display**

**OFFLINE:**

When this switch is pressed, the GP enters the OFFLINE mode.

**Trend Key:**

This function switch corresponds to the Data Record Display of the Trend Graph and is the same as the one that is automatically placed together with the Trend Graph. This switch can be used only with GP2000 Series units. Designate the touch key used to execute the ON/OFF status of the Data Record Display mode, scroll direction of the displayed data, and number of lines being rolled up or down.

**▼Reference▲ 2.1.12 Trend Graphs**

**Q-tag Selection Key:**

This function switch corresponds to the Alarm Summary Display of Q-tag and is the same as the Q-tag Selection key set up using T-tag. Used as the Alarm Operation Key in the Q-tag display area.

**▼Reference▲ Tag Reference Manual 2.23 Touch Panel Input <T-tag>**

## ■ Function Switch [Shape/Color] Attributes

The Switch's color, and pattern are selected here.

**▼Reference▲ 2.1 Parts ■ Selecting Colors**

The color and pattern settings available will differ depending on the switch shape.

■ **Function Switch [Label] Attributes**

Here, the characters shown (drawn) on the Switch button face are entered.

▼ **Reference** 2.1 Parts ■ *Creating Labels*

■ **Function Switch [Extend] Attributes**

Here, the interlock and the buzzer are set.

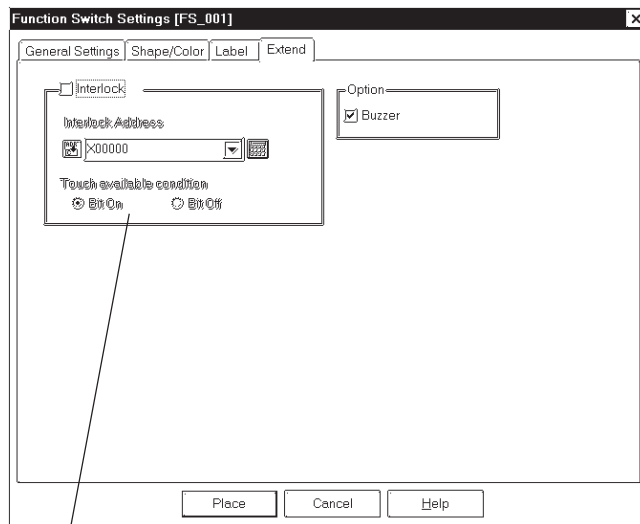

Select the Interlock function state

◆ **Interlock**

Only when a bit designated via Interlock Address is in a state that has been selected via [Touch available condition], the switch becomes effective. Whether the switch is effective in ON state or in OFF state is selectable here.



**Note:** The “Bit Off” is available only with the GP-377, GP77R and GP2000 series.

Touch Available Condition	Interlock Address Status	Touch Available/ Not Available
Bit ON	ON	Touch Available
	OFF	Touch Not Available
Bit OFF	ON	Touch Not Available
	OFF	Touch Available

◆ **Buzzer**



Sets the buzzer to ON/OFF.

■ **Placing a Function Switch**

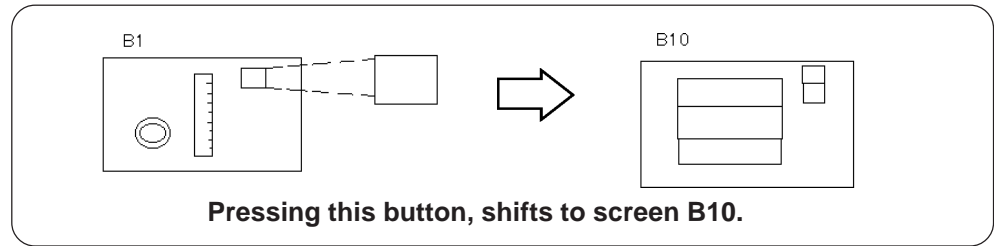
The Screen Switching (Function) Switch's placement procedure is shown below.

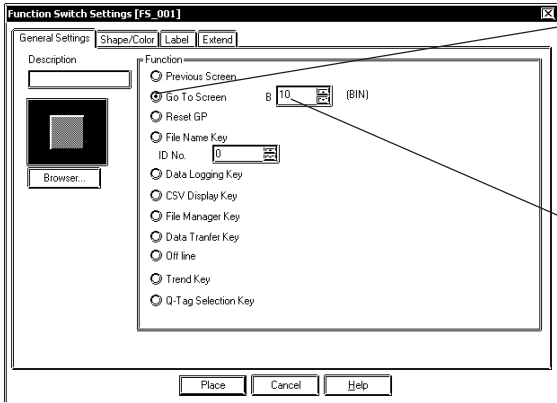
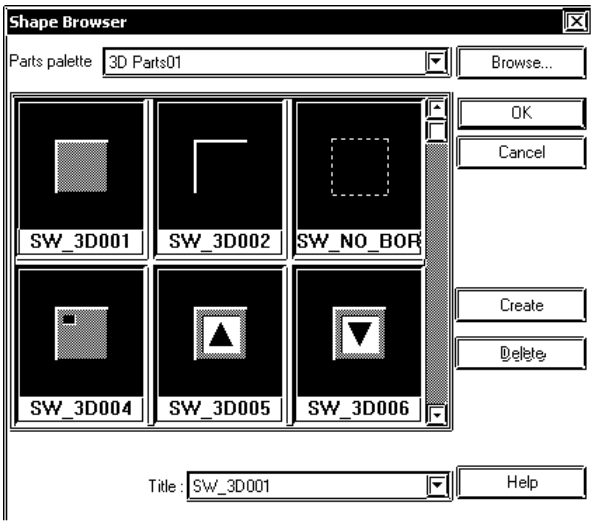

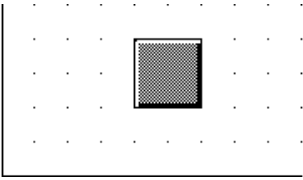
PROCEDURE	REMARKS
<p>(1) Select the [Parts] menu - [Function Switch] command, or click on the  icon.</p> <p>(2) Designate the [Function] on the [General Settings] tab.</p> 	
<p>(3) Select a Part Shape from the Browser. Specify settings for Shape/Color, Label and Extension Settings if necessary.</p> 	<p><b>Reference</b> 2.1 Part ■ <i>Selecting a Part Shape</i></p> <p>Image Parts can be used with the GP2000 series.</p>

PROCEDURE	REMARKS
<p>(4)After all of Part's attributes have been entered or selected, click on the  button.</p> <p>The Switch's outline will appear in the Base screen, next to the cursor.</p> <p>(5)Click on the point where the Switch's top left corner is to be placed.</p> <p>If necessary, use the Switch's handles to alter its size.</p> 	<p>To cancel the placement, click on the  icon.</p> <p><b>Reference</b> To change the Part's size, refer to <b>2.4.3 Scaling Up/Down</b></p> <p>Double-clicking on any Part placed on the screen calls up that Part's Attribute Setting dialog box.</p> <p><b>Reference</b> <b>2.4.14 Changing Attributes</b></p>

### 2.1.4 Toggle Switches

Here a toggle type touch panel switch, used to turn a specified Bit ON or OFF is created.



**Note:** A Toggle Switch will not be displayed on the GP when transferred, if the GP has not yet been connected to the device.

#### ■ Toggle Switch [General Settings] Attributes

Enter comment data here

Changes the state of the dialog box's switch display to either ON or OFF

Displays the currently selected Part

Calls up the Part Shape Browser where a different Part Shape can be selected

Enter the Bit Address to be operated via the Switch

Enter the desired Monitor Bit Address here

#### ◆ Operation Bit Address

The number of the Bit Address to be operated via the Switch is entered here.

#### ◆ Monitor Bit Address

Here, the Monitor Bit Address used to change the Switch's display is entered. The Switch's ON/OFF state can be made to change according to changes in the Monitor Bit Address data. The same address as the Bit Address's can be used here.

After entering the Bit Address, if you attempt to perform another area's operation before entering the Monitor Bit Address's data, the dialog box shown below will appear. Clicking on the  button automatically enters the Bit Address data. To input an address different from the Bit Address, click on the  button and input the desired Monitor Bit Address.

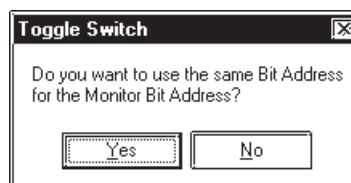

■ **Toggle Switch [Shape/Color] Attributes**

The Switch's frame colors (Frame) for the ON and OFF states can be selected.

▼ **Reference** 2.1 Parts ■ **Setting Colors**

The color and pattern settings available will differ depending on each switch's settings, such as its shape and state change conditions.

■ **Toggle Switch [Label] Attributes**

Here, the text characters shown (Raised) on the Switch button face are entered.

▼ **Reference** 2.1 Parts ■ **Setting Labels**

■ **Toggle Switch [Extend] Attributes**

Here, the interlock and the buzzer are set.

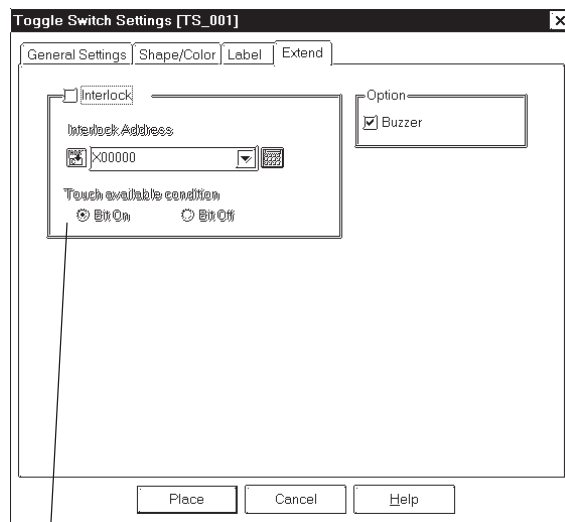

Select the Interlock function state

◆ **Interlock Address**

Only when a bit designated via Interlock Address is in a state that has been selected via [Touch available condition], the switch becomes effective. Whether the switch is effective in ON state or in OFF state is selectable here.



**Note:** This “Bit Off” feature is available only with the GP-377, GP77R and GP2000 series.

Touch Available Condition	Interlock Address Status	Touch Available/ Not Available
Bit ON	ON	Touch Available
	OFF	Touch Not Available
Bit OFF	ON	Touch Available
	OFF	Touch Not Available





◆ **Buzzer**

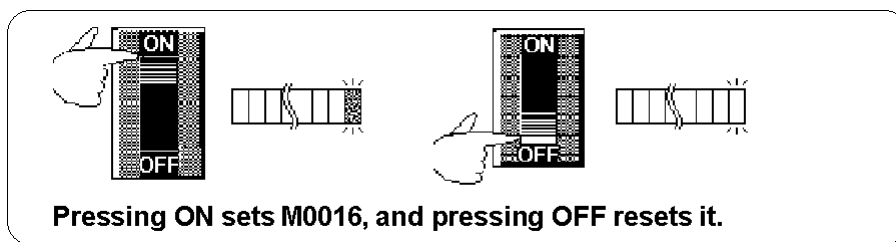

Sets the buzzer to ON/OFF.

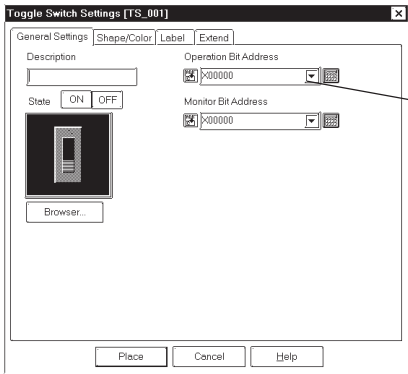
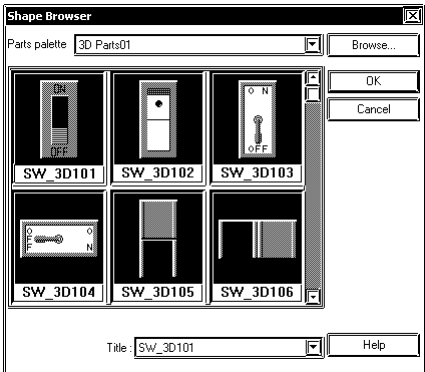
■ **Placing a Toggle Switch**

The Toggle Switch placement procedure is shown below.

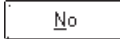

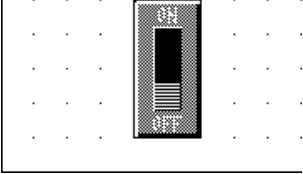
PROCEDURE	REMARKS
<p>(1) Select the [Parts] menu - [Toggle Switch] command, or click on the  icon.</p> <p>(2) In the [General Settings] area, input the Operation Bit Address.</p>  <p>(3) Select a Part Shape from the Browser. Specify settings for Shape/Color, Label and Extension Settings if necessary.</p>  <p>(4) After all of a Part's attributes have been entered or selected, click on the  button.</p> <p>The Switch's outline will appear in the Base screen, next to your cursor.</p>	<p>After entering the Operation Bit Address, if you attempt to perform another area's operation before entering the Monitor Bit Address data, the dialog box shown below will appear.</p>  <p>Clicking on the  button automatically inputs the Operation Bit Address into the Monitor Bit Address area. To input an address different from the Bit Address, click on the  button.</p> <p><b>Reference</b> 2.1 Parts ■ <i>Selecting a Part Shape</i></p>

PROCEDURE	REMARKS
<p>(5) Click on the point where the Switch's top left corner is to be placed.</p> <p>If desired, use the Switch's handles to alter its size.</p> 	<p>To cancel the placement, click on the  icon.</p> <p><b>Reference</b> To change a Part's size, refer to <i>2.4.3 Scaling Up/Down</i></p> <p>Double-clicking on any Part placed on the screen automatically calls up that Part's attribute settings.</p> <p><b>Reference</b> <i>2.4.14 Changing Attributes</i></p>



## 2.1.5 Lamps

Here a lamp is created, which turns ON or OFF according to the device's Monitor Bit Address state.



- **Lamps will not display on the GP unless the GP has been connected to the device.**
- **When placing a Lamp, DO NOT overlap it with other objects. If you do so, it may not be displayed correctly.**

### ■ Lamp [General Setting] Attributes

Enter comment data here

Displays the currently selected Part

Calls up the Part Shape Browser. Part Shapes can be selected directly from here

Enter the desired Bit Address here

Changes the state of the dialog box's switch display to either ON or OFF

### ◆ Bit Address

The Bit Address to be monitored is entered here.

### ■ Lamp [Shape/Color] Attributes

Here, border colors for both ON and OFF states, and Lamp's colors and tiling pattern in each state can be selected.

#### ▼ Reference ▲ 2.1 Parts ■ Selecting Colors

The color and pattern settings available will differ depending on each lamp shape.

### ■ Lamp [Label] Attributes



Here, the text characters shown on a Lamp button's face are entered.

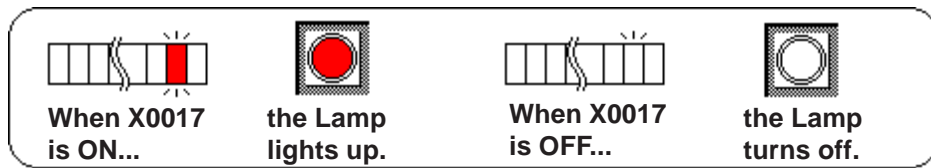

#### ▼ Reference ▲ 2.1 Parts ■ Creating Labels

■ **Placing a Lamp**

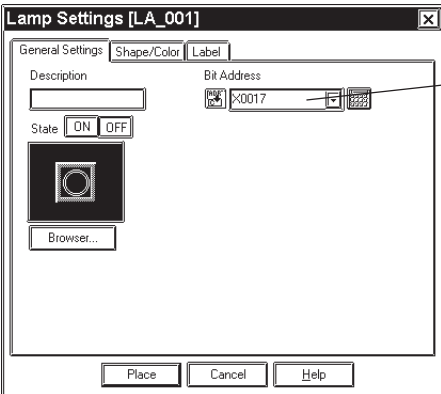
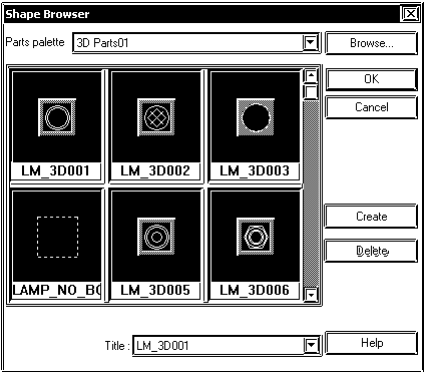
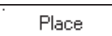
The procedures for creating and placing a Lamp are shown below.

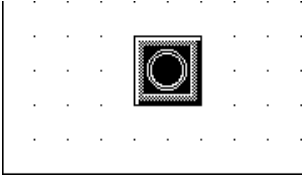

PROCEDURE	REMARKS
<p>(1) Select the [Parts] menu - [Lamp] command, or click on the  icon.</p> <p>(2) In the [General Settings] area, enter a Bit Address.</p>  <p>(3) Select a Part Shape from the Browser. Select Colors and input a Label, if desired.</p>  <p>(4) Switch the state of the lamp with the On/Off buttons, and then select Colors and input a Label.</p> <p>(5) After all of the Lamp's attributes have been entered or selected, click on the  button.</p> <p>The Lamp's outline will appear in the Base screen, next to your cursor.</p>	<p><b>Reference</b> 2.1 Parts ■ <i>Selecting a Part Shape</i></p> <p>Image Parts can be used with the GP2000 series.</p> <p>With the Blink check box checked , and if the Bit is turned ON, the Lamp will blink. Lamp blinking can also be seen via the pull down menu [View]'s [Preview] command.</p> <p><b>Reference</b> 2.10.3 <i>Preview Screen</i></p>

PROCEDURE	REMARKS
<p>(6) Click on the point where the Lamp's top left corner is to be placed.</p> <p>If necessary, use the Lamp's handles to alter its size.</p> 	<p>To cancel the placement, click on the  icon.</p> <p><b>Reference</b> To change the Part's size, refer to <i>2.4.3 Scaling Up/Down</i></p> <p>Double-clicking on any Part placed on the screen automatically calls up that Part's attribute settings.</p> <p><b>Reference</b> <i>2.4.14 Changing Attributes</i></p>

**2.1.6 4-State Lamp**

Here, a 4-State Lamp, which changes its state according to whether the device's two Monitor Bits are ON or OFF, are created.



- **Even when a 4-State Lamp data is transferred to the GP, if the GP and device have not communicated, the 4-State Lamp will not be displayed on the GP.**
- **When placing a 4-State Lamp, DO NOT overlap it with other objects. If you do so, it may not be displayed correctly.**

**■ Features of 4-State Lamp**

Enter comment data here, if necessary.

Changes the state of the Lamp currently displayed on the dialog box to either ON or OFF.

Displays the currently selected Part's image.

Calls up the Part Shape Browser. A Part Shape can be selected directly from here.

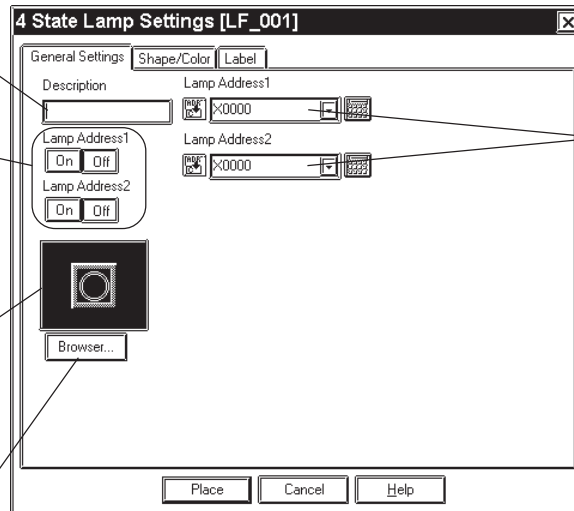

Enter a desired Bit Address to be monitored.

**◆ Lamp Address**

Enter the two Bit Addresses (Lamp Addresses 1 and 2) to be monitored.

**◆ Lamp Address  On  Off**

Changes the Lamp state by changing the combination of the two Bit's ON/OFF state.



**Note:** When the two Bits that have been assigned to the Lamp Addresses are changed simultaneously, the Lamp state change is recognized as follows according to the Bit read timing, which makes the Lamp display flicker.

e.g.) When Lamp Addresses 1 and 2 are changed from OFF to ON simultaneously:

Lamp Address 1	0 → 0 → 1
Lamp Address 2	0 → 1 → 1

Or

Lamp Address 1	0 → 1 → 1
Lamp Address 2	0 → 0 → 1

■ Features of 4-State Lamp [Shape/Color]

Here, a 4-State Lamp's border colors for both ON and OFF states and Lamp's colors and tiling pattern in each state can be selected.

▼ **Reference** 2.1 Parts ■ *Selecting Colors*

The color and pattern settings available (effective) will differ depending on each Lamp shape.

■ Features of 4-State Lamp [Label]

Here, the text characters shown on a Lamp button's face are entered.

▼ **Reference** 2.1 Parts ■ *Creating Labels*

■ Positioning a Lamp

The procedure for creating and placing a 4-State Lamp are shown below.

The Lamp state will be switched according to the Lamp Addresses X0017's and X0018's ON/OFF states.



When X0017 is OFF and X0018 is OFF



When X0017 is ON and X0018 is OFF





When X0017 is ON and X0018 is ON

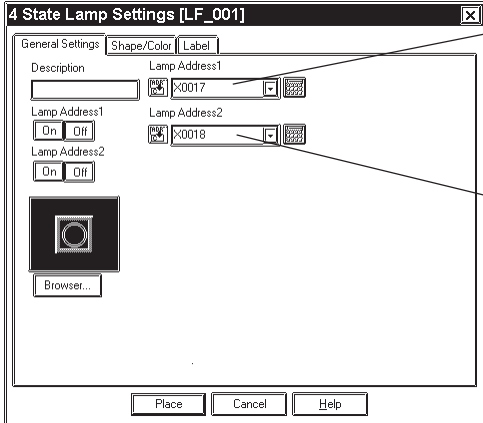

When X0017 is OFF and X0018 is ON

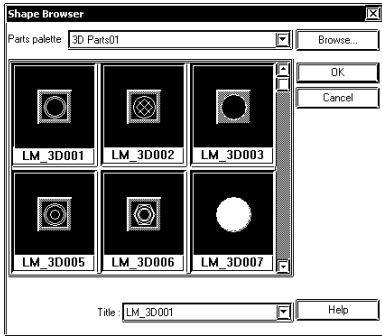
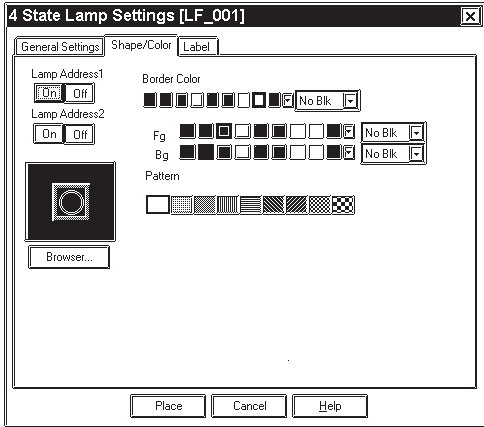
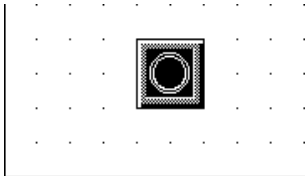
PROCEDURE	REMARKS
<p>(1) Select the [Parts] menu - [4-State Lamp] command, or click on the  icon.</p> <p>(2) Enter Lamp Addresses 1 and 2 in the [General Settings] tab.</p> 	

PROCEDURE	REMARKS
<p>(3) <b>Select a Part Shape from the Browser.</b>                      Select Colors and set up a Label, if desired.</p>  <p>(4) <b>User either <input type="checkbox"/> On or <input type="checkbox"/> Off button to change the Lamp Address states and select Colors and Pattern for each state.</b>                      Set up a Label for each state, if desired.</p>  <p>(5) <b>After all of a Part's attributes have been entered or selected, click on the <input type="button" value="Place"/> button.</b>                      The 4-State Lamp's outline will appear on the Base screen, next to your cursor.</p> <p>(6) <b>Click on the point where the 4-State Lamp's top corner is to be placed.</b>                      Use the 4-State Lamp's handles to alter its size, if necessary.</p> 	<p><b>Reference</b> <a href="#">2.1 Parts</a> ■ <i>Selecting a Part Shape</i></p> <p>To cancel the placement, click on the  icon.</p> <p><b>Reference</b> <a href="#">2.4.3</a> <i>Scaling Up/Down.</i></p> <p>Double-clicking on any Part placed on the screen automatically calls up that Part's attribute settings.</p> <p><b>Reference</b> <a href="#">2.4.14</a> <i>Changing Attributes</i></p>

## 2.1.7 Bar Graphs

Here the setup (creation and placement) of a bar graph is explained. Bar Graphs are used to display device Word Address numeric data in absolute or relative values. This graph's display will change according to Word Address data changes.

### ■ Bar Graph [General Settings] Attributes

<When displaying Word Address numeric data in absolute values>

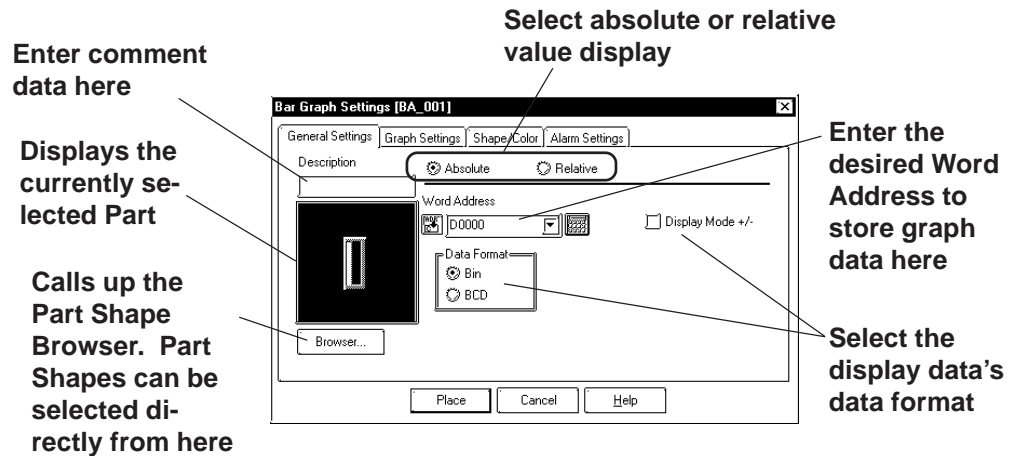

#### ◆ Absolute

Data stored in the Word Address is displayed in absolute values from 0 to 100 (with Display Mode +/- selected, -100 to 100).

#### ◆ Word Address

Here, enter the Word Address used for storing the Bar Graph's data.

#### ◆ Data Format

The display data's format can be either Bin or BCD.

When Bin is selected, negative numeric data can also be displayed. In that case, check  the Display Mode +/- check box.

## &lt;When displaying Word Address numeric data in relative values&gt;

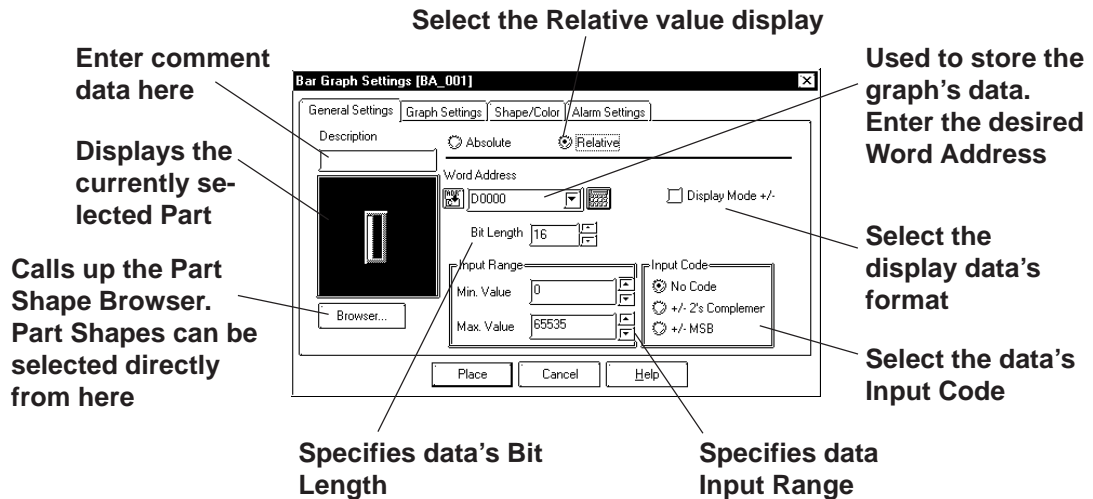
◆ **Relative**

The data stored in the Word Address are converted to a value between 0 and 100 according to the designated Input Range and displayed as relative values.

◆ **Word Address**

Here, enter the Word Address used for storing the Bar Graph's data.

◆ **Display Mode +/-**

When this check box  is checked, negative numeric data can also be displayed.

◆ **Bit Length**

Specifies the Bit Length of data stored in the Word Address.

◆ **Input Range**

Specifies the data's Input Range.

◆ **Input Code**

When No Code is selected, only positive data can be entered. To enter negative number data, select +/- 2's Complement or +/- MSB.



### ■ Bar Graph [Graph Settings] Attributes

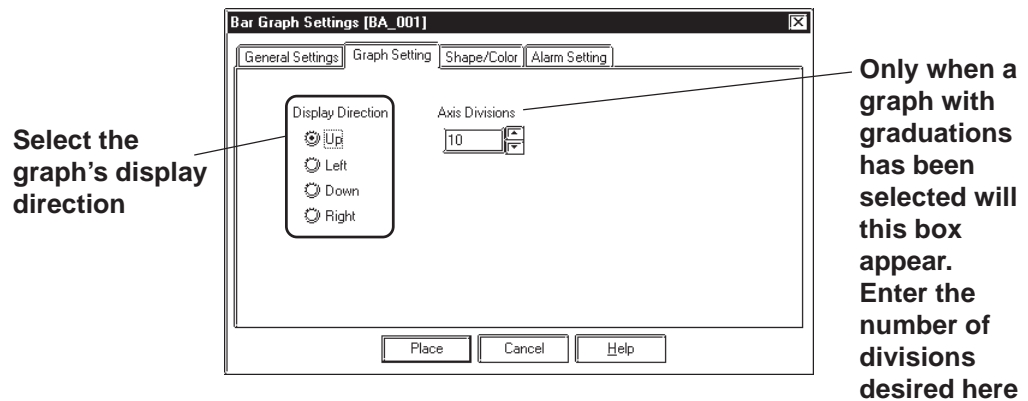

#### ◆ Direction

The graph's display direction can be specified as either Up, Left, Down, or Right.

**Note:** If [Display Direction] is changed for a 3D part, its shade is rotated along with that part. To let the shade displayed properly, click on the  button, and select the part again from [Shape Browser].

#### ◆ Axis Divisions

For a graph which has graduations, the number of divisions are entered here. If the number of the divisions is specified to 10, then 11 division lines are used. When graduations are not necessary, specify the number of the divisions as 0.

**Note:** Whether the graduations are necessary or not will differ depending on the Part's shape.

### ■ Bar Graph [Shape/Color] Attributes

The graph's border color, division color (Axis Color), display data color (Graph Color), display data patterns, and background color are selected here.

**Reference** 2.1 Parts ■ *Selecting Colors*

### ■ Bar Graph [Alarm Settings] Attribute



If desired, an Alarm can be setup here by toggling the Alarm check box.

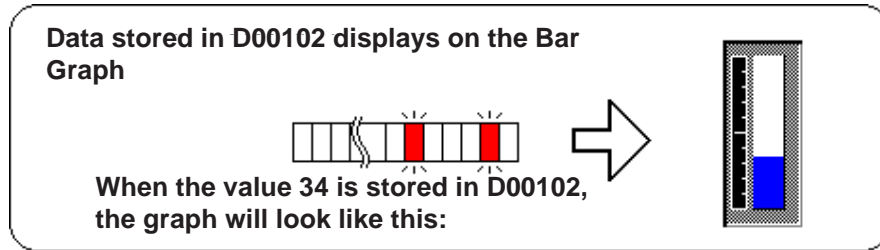

**Reference** 2.1 Parts ■ *Setting Alarms*

### ■ Placing a Bar Graph

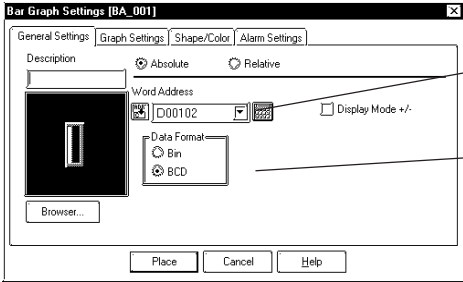
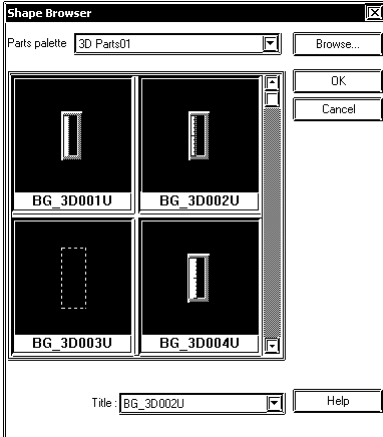
An example of the Bar Graph's creation and placement procedures are shown below.

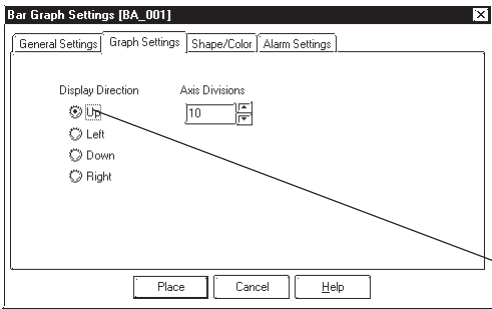
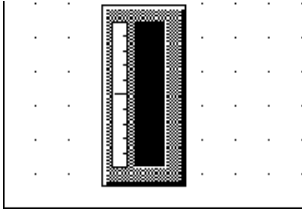

PROCEDURE	REMARKS
<p>(1) Select the [Parts] menu - [Bar Graph] command, or click on the  icon.</p> <p>(2) In the [General Settings] tab, input a Word Address and select a Data Format.</p>  <p>(3) Select a Part Shape that has graduations from the <b>Browser</b>. Here, you can enter Alarm settings and select Colors, if desired.</p> 	<p><b>Reference</b> 2.1 Parts ■ <i>Selecting a Part Shape</i></p> <p>If the Bar Graph's Alarm value is specified as Variable, a pointer showing levels will be displayed. This pointer's position will move according to the specified Alarm value.</p> 

PROCEDURE	REMARKS
<p>(4) In the [Graph Settings] tab, select the graph's display direction and input the number of Axis Divisions.</p>  <p>(5) After all of the graph's attributes have been entered or selected, click on the <input type="button" value="Place"/> button.</p> <p>The Bar Graph's outline will appear on the Base screen, next to your cursor.</p> <p>(6) Click on the point where the Bar Graph's top left corner is to be placed.</p> <p>If necessary, use the Bar Graph's handles to adjust its size.</p> 	<p>The area to enter the number of the divisions will appear only for a graph type which has axis divisions.</p> <p>To cancel the placement, click on the  icon.</p> <p><b>Reference</b> To change the Part's size, refer to <b>2.4.3 Scaling Up/Down</b></p> <p>Double-clicking on any Part placed on the screen automatically calls up that Part's attribute settings.</p> <p><b>Reference</b> <b>2.4.14 Changing Attributes</b></p> <p>The Bar Graph's sizing handles are located inside the graph.</p>

## 2.1.8 Pie Graphs

Pie Graphs create an area where a device's Word Address data is displayed as absolute values. The graph's display will change to reflect changes in the designated Word Address data.

### ■ Pie Graph [General Settings] Attributes

<When displaying the data using absolute values>

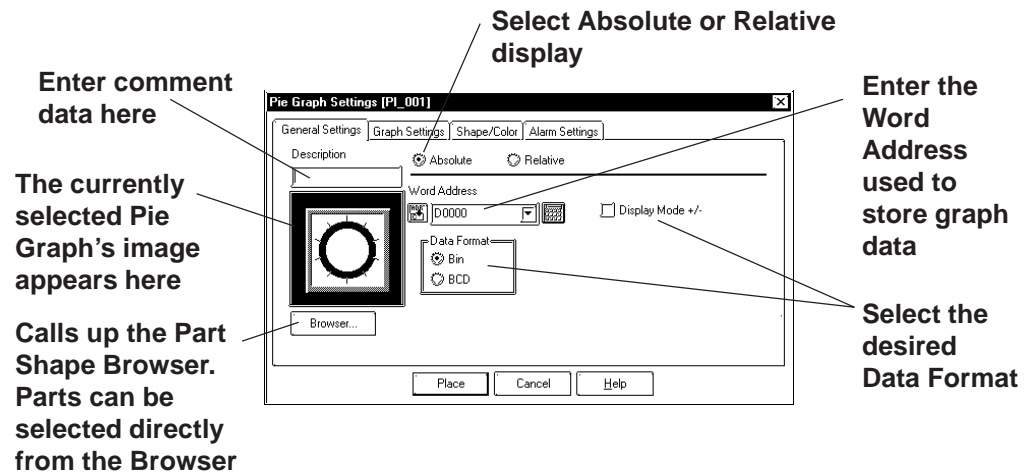

#### ◆ Absolute

Data stored in the designated Word Address is displayed in absolute values, from 0 to 100 (with Display Mode +/- selected, -100 to 100).

#### ◆ Word Address

Here, the Word Address' location data is entered to show where the desired data is stored.

#### ◆ Data Format

Select either the Bin and BCD display formats.

#### ◆ Display Mode +/-

With this check box  checked and the Bin data format is selected, a negative numeric data can also be displayed.

## &lt;When displaying the data using relative values&gt;

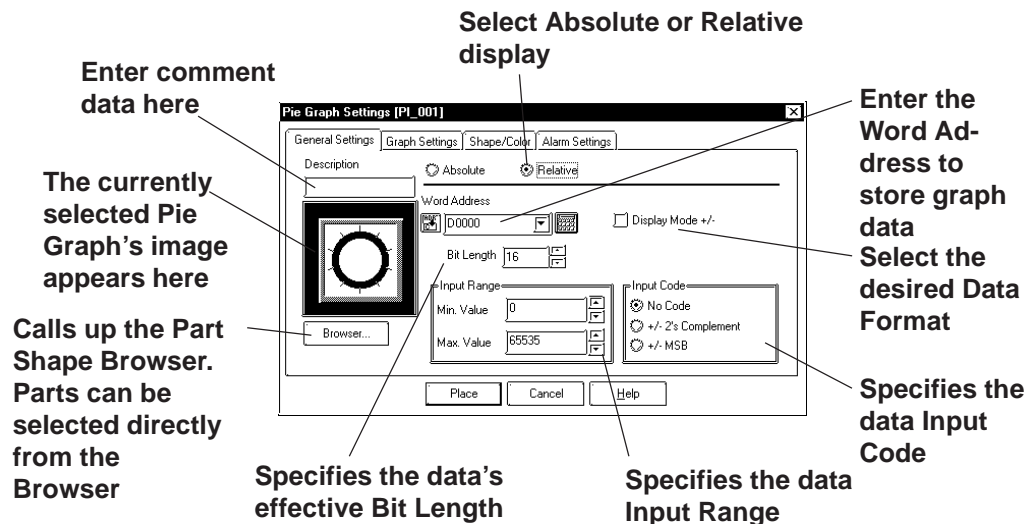
◆ **Relative**

The data stored in the Word Address are converted to a value between 0 and 100 according to the designated Input Range and displayed as relative values.

◆ **Word Address**

Here, enter the Word Address used to store Pie Graph data.

◆ **Display Mode +/-**

When this check box  checked, negative numeric data can also be displayed.

◆ **Bit Length**

Specifies the Bit Length of all data stored in the Word Address.

◆ **Input Range**

Specifies the data's Input Range.

◆ **Input Code**

With No Code selected, only positive numeric data can be entered. To enter negative numeric data, select either +/-2's Complement or +/-MSB.

## ■ Pie Graph [Graph Settings] Attributes

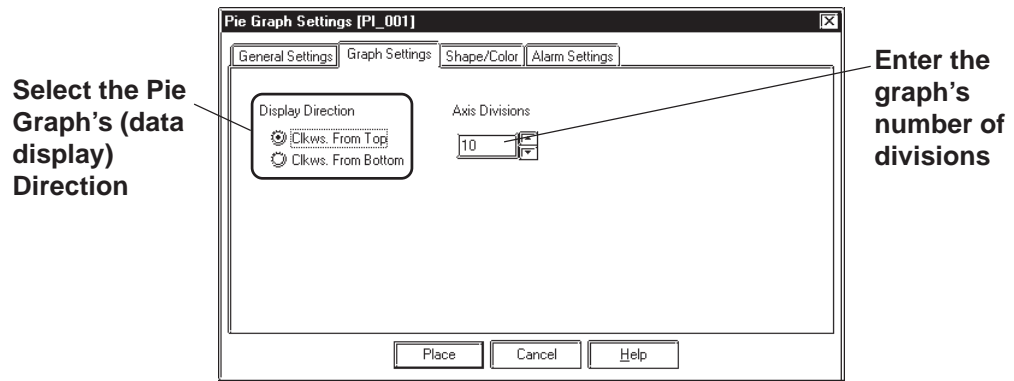

### ◆ Display

Here, the graph's data display start point, either Clkws. From Top or Clkws. From Bottom, can be selected.



**Note:** If [Display Direction] is changed for a 3D part, its shade is rotated along with that part. To let the shade displayed properly, click on the  button, and select the part again from [Shape Browser].

### ◆ Axis Divisions

The number of segments the Pie Graph will be divided into is entered here. If the number of Axis Divisions is specified as 10, 10 division lines will be displayed. When no divisions are necessary, simply enter 0.

## ■ Pie Graph [Shape/Color] Attributes

A Pie Graph's border color, division line color (Axis Color), data display color (Graph Color - Fg and Bg), data display pattern and background color are selected here.

**Reference** 2.1 Parts ■ *Selecting Colors*

## ■ Pie Graph [Alarm Settings] Attributes

Clicking on the Alarm Display check box will call up the Alarm Settings.

**Reference** 2.1 Parts ■ *Alarm Settings*

■ **Placing a Pie Graph**

The procedure for placing a Pie Graph is shown below.

**Data stored in D0102 displays on the Pie Graph**



**When the value 34 is stored in D0102, the graph appears like this:**

PROCEDURE	REMARKS
-----------	---------

(1) Select the [Parts] menu - [Pie Graph] command, or click on the  icon.

(2) In the [General Settings] area, input a Word Address and select a Data Format.

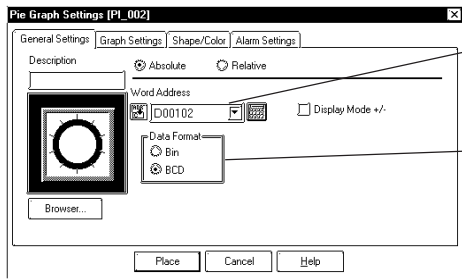

Enter **D00102** here



Select **BCD**

(3) Select a Part Shape from the Browser.

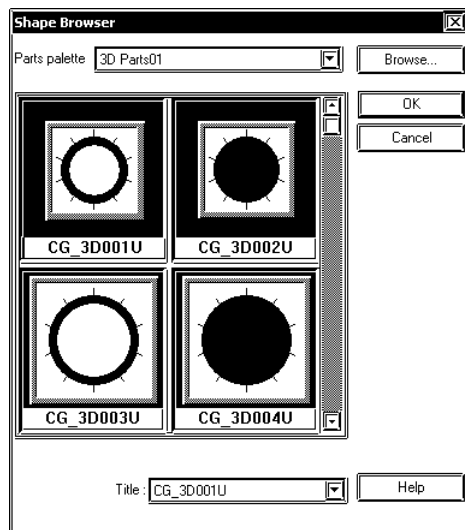
You can also use the Alarm Settings area to choose an Alarm and select Colors, if desired.

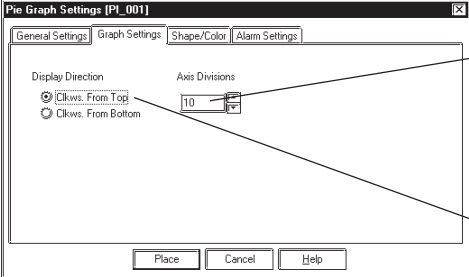
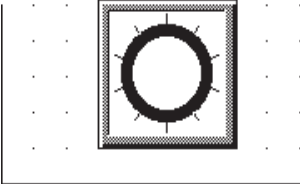

**Reference** 2.1 Parts ■ *Selecting a Part Shape*

PROCEDURE	REMARKS
<p><b>(4) In the [Graph Settings] tab, select the display direction and input the number of Axis Divisions.</b></p>  <p><b>(5) After all of the Graph's attributes have been entered or selected, click on the <input type="button" value="Place"/> button.</b></p> <p>A Pie Graph's outline will appear on the Base screen, next to the cursor.</p> <p><b>(6) Click on the point where the Pie Graph's top left corner is to be placed.</b></p> <p>If desired, use the Pie Graph's handles to alter its size.</p> 	<p>The area to enter the number of the divisions will appear only for a graph type which has axis divisions.</p> <p>To cancel the placement, click on the  icon.</p> <p><b>Reference</b> To change the Part's size, refer to <b>2.4.3 Scaling Up/Down</b></p> <p>Double-clicking on any Part placed on the screen automatically calls up that Part's attribute settings.</p> <p><b>Reference</b> <b>2.4.14 Changing Attributes</b></p>



## 2.1.9 Half Pie Graphs

This graph displays a Word Address' numeric data (received from a device) as absolute or relative values in a Half-Pie graph. The graph's display will also change to reflect Word Address data changes.

### ■ Half Pie Graph [General Settings] Attributes

<When displaying the data in absolute values>

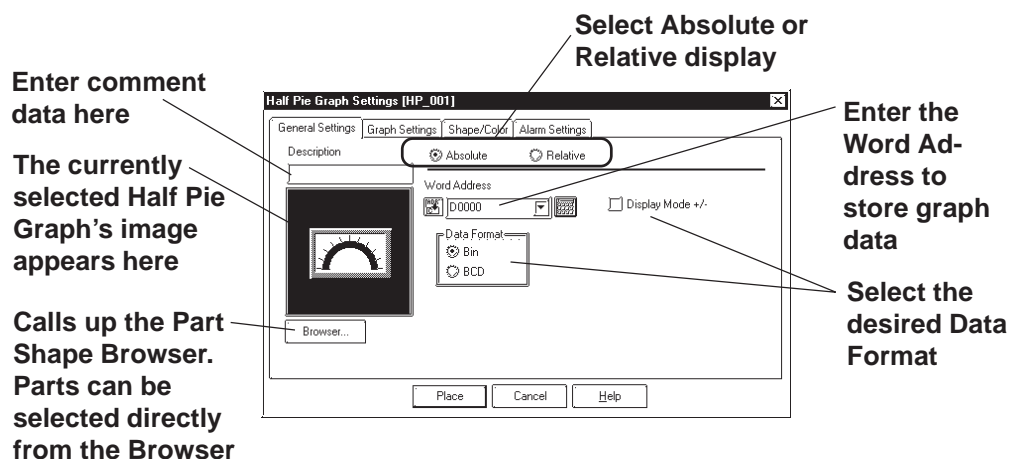

#### ◆ Absolute

Data stored in the designated Word Address is displayed as absolute values, from 0 to 100 (with Display Mode +/- selected, -100 to 100).

#### ◆ Word Address

Enter the Word Address where the data will be stored.

#### ◆ Data Format

Select the display data format from Bin and BCD.

#### ◆ Display Mode +/-

When this check box  is checked and Bin data format is selected, negative numeric data can be displayed.

## &lt;When displaying the data in relative values&gt;

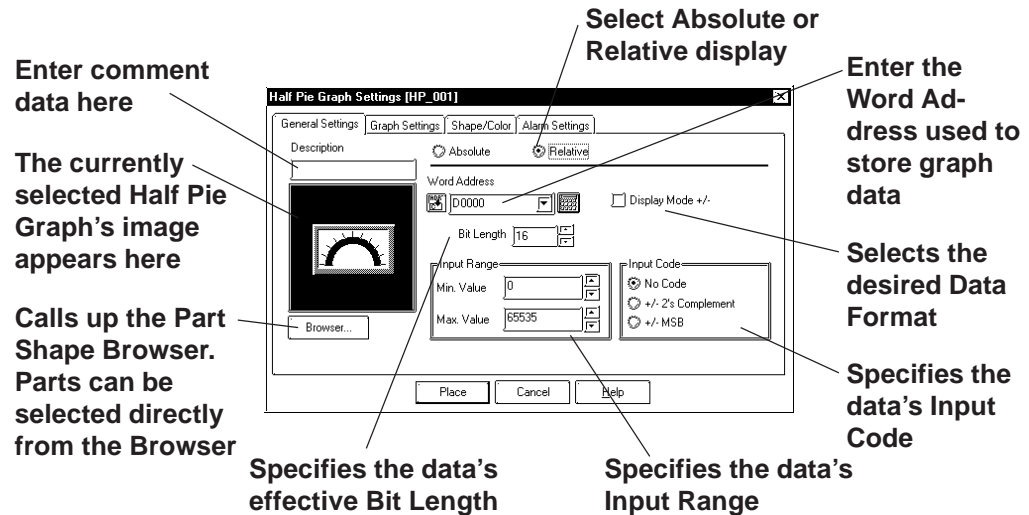
◆ **Relative**

The data stored in the Word Address are converted to a value between 0 and 100 according to the designated Input Range and displayed as relative values.

◆ **Word Address**

Here, enter the Word Address used to store Half Pie Graph data.

◆ **Display Mode +/-**

When this check box  checked, negative number data can be displayed.

◆ **Bit Length**

Specifies the Bit Length of all data stored in the Word Address.

◆ **Input Range**

Specifies the data's Input Range.

◆ **Input Code**

With No Code selected, only positive numeric data can be entered. To enter negative numeric data, select either +/-2's Complement or +/-MSB.

## ■ Half Pie Graph [Graph Settings] Attributes

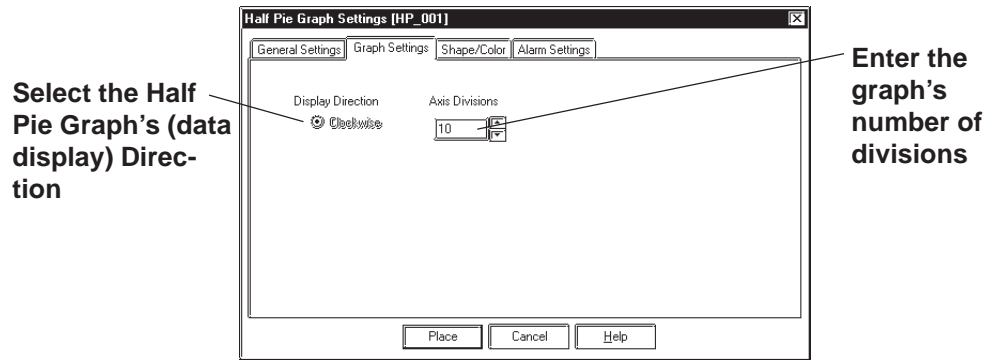

### ◆ Display Direction

Here, the Half Pie graph's display direction is fixed to clockwise.

### ◆ Axis Divisions

The data entered here determines how many pieces a Half Pie Graph is divided into. If the number of Axis Divisions is specified as 10, 11 division lines are displayed. When no divisions are necessary, specify the number of divisions as 0.

## ■ Half Pie Graph [Shape/Color] Attributes

Here, a Half Pie graph's border color, division color (Axis Color), display data color (Graph Color - Fg & Bg), display data pattern and background color are selected here.

**Reference** 2.1 Parts ■ *Selecting Colors*

## ■ Half Pie Graph [Alarm Settings] Attributes

If desired, Alarm settings can be set here.



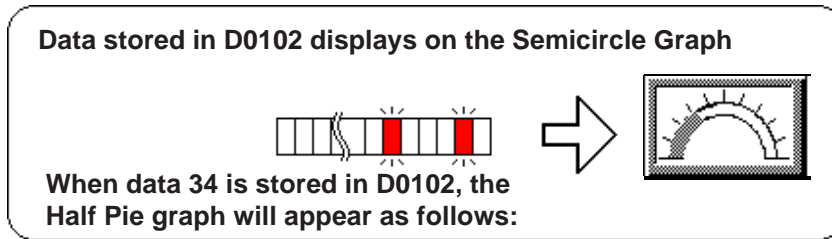

**Reference** 2.1 Parts ■ *Alarm Settings*

■ **Placing a Half Pie Graph**

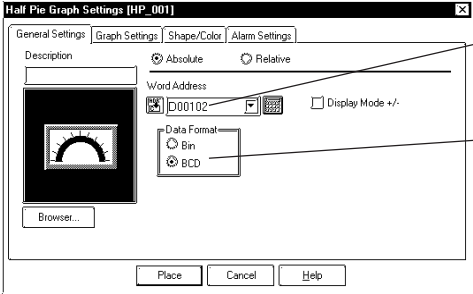
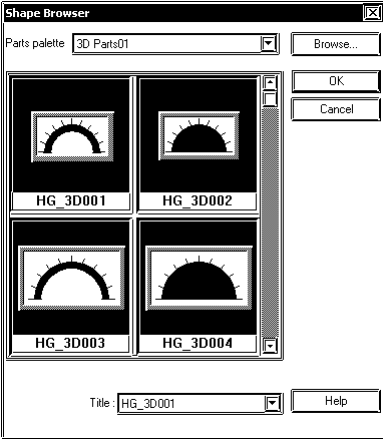
The procedure for placing a Half Pie Graph is as shown below.

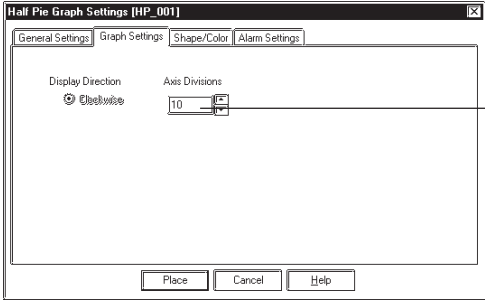

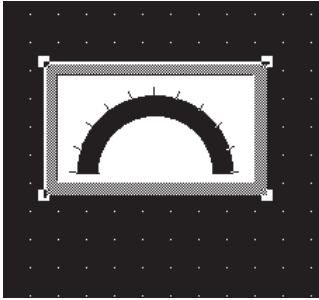
PROCEDURE	REMARKS
<p>(1) Select the [Parts] menu - [Half Pie Graph] command, or click on the  icon.</p> <p>(2) In the [General Settings] area, input the Word Address and Data Format.</p> <div style="display: flex; align-items: center;">  <div style="margin-left: 20px;"> <p>Enter <b>D00102</b></p> <p>Select <b>BCD</b></p> </div> </div> <p>(3) Select a Part Shape from the Browser.</p> <p>You can also use the Alarm Settings area to enter Alarm settings and select Colors, if desired.</p> <div style="display: flex; align-items: center;">  </div>	<p style="text-align: center; font-weight: bold; margin-top: 20px;">▼ <i>Reference</i> ▲ 2.1 Parts ■ <i>Selecting a Part Shape</i></p>

PROCEDURE	REMARKS
<p>(4) In the [Graph Settings] tab, input the number of axis divisions.</p>  <p>(5) After all of a Part's attributes have been entered or selected, click on the  button.</p> <p>The Half Pie graph's outline will appear on the Base screen, next to your cursor.</p> <p>(6) Click on the point where the Half Pie Graph's top left corner is to be placed.</p> <p>If desired, use the Half Pie graph's handles to alter its size.</p> 	<p>The area to enter the number of the divisions will appear only for a graph type which has axis divisions.</p> <p>To cancel the placement, click on the  icon.</p> <p><b>Reference</b> To change the Part's size, refer to <b>2.4.3 Scaling Up/Down</b></p> <p>Double-clicking on any Part placed on the screen automatically calls up that Part's attribute settings.</p> <p><b>Reference</b> <b>2.4.14 Changing Attributes</b></p>

### 2.1.10 Tank Graphs

This Part creates an area where a Word Address' numeric data received from the Host (device) is displayed as absolute or relative values in a special "Tank" shaped graph. The graph's display will change to reflect changes in Word Address data.



**Note:** Regarding the following parts, if the value of 100 on the scale is displayed, the graph area may not be filled completely depending on display magnification. In this case, the graph can be displayed properly by enlarging or reducing the part by one dot.

- Part file name: op4-3d01.pdb  
GR\_3D007, GR\_3D008, GR\_3D010, GR\_3D015, GR\_3D017
- Part file name: op4-p101.pdb  
GR\_PL007, GR\_PL008, GR\_PL010, GR\_PL015, GR\_PL017

#### ■ Tank Graph [General Settings] Attributes

<When displaying data in absolute values>

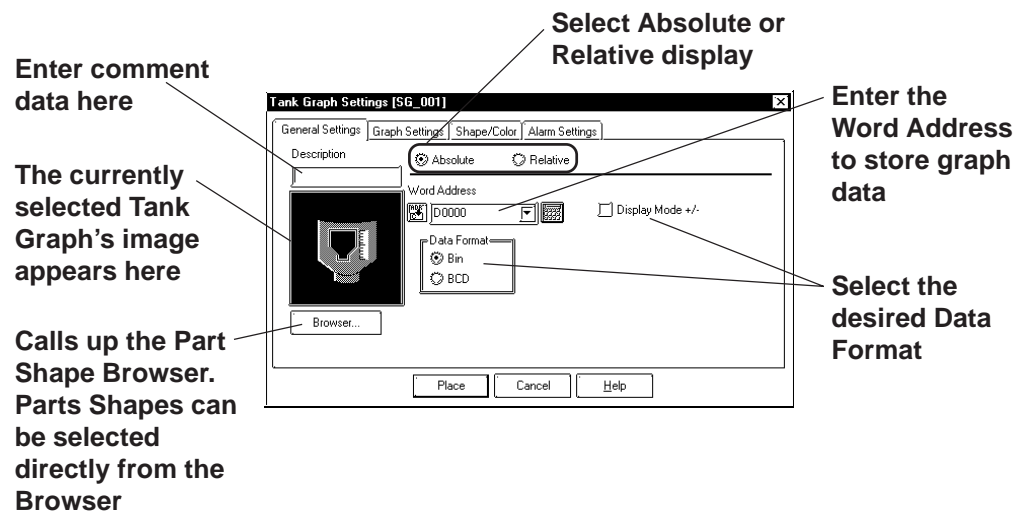

#### ◆ Absolute

Data stored in the designated Word Address is displayed as absolute values, from 0 to 100 (with Display Mode +/- selected, -100 to 100).

#### ◆ Word Address

Enter the Word Address where the data will be stored.

#### ◆ Display Mode

Select the display data format from Bin and BCD.

#### ◆ Display Mode +/-

When this check box  is checked and Bin data format is selected, negative numeric data can be displayed.

## &lt;When displaying data in relative values&gt;

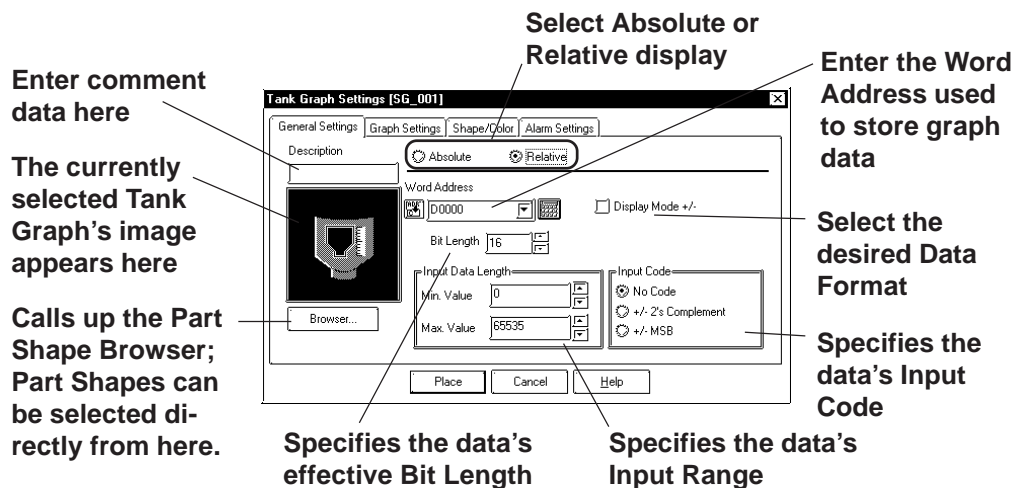
◆ **Relative**

The data stored in the Word Address are converted to a value between 0 and 100 according to the designated Input Range and displayed as relative values.

◆ **Word Address**

Here, enter the Word Address used to store Tank Graph data.

◆ **Display Mode +/-**

When this check box  checked, negative number data can be displayed.

◆ **Bit Length**

Specifies the Bit Length of all data stored in the Word Address.

◆ **Input Data Length**

Specifies the data's Input Range.

◆ **Input Code**

With No Code selected, only positive numeric data can be entered. To enter negative numeric data, select either +/-2's Complement or +/-MSB.

## ■ Tank Graph [Graph Settings] Attributes

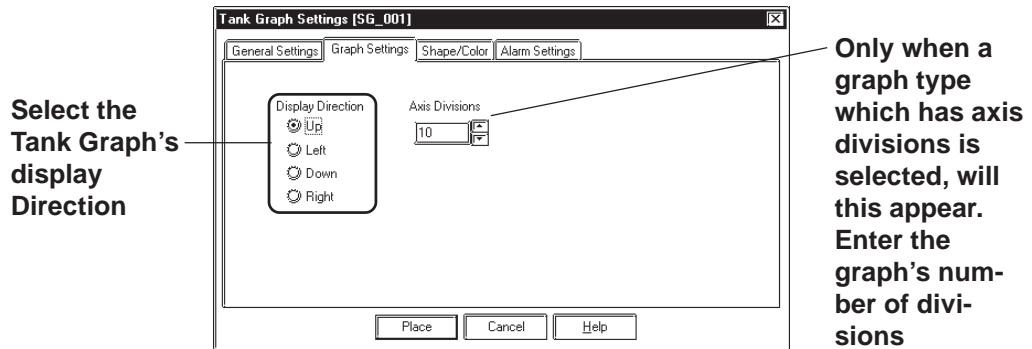

### ◆ Display Direction

Here, Up, Left, Down, or Right can be selected for the Tank graph's display direction.

The display direction varies depending on the part types.



**Note:** If [Display Direction] is changed for a 3D part, its shade is rotated along with that part. To let the shade displayed properly, click on the  button, and select the part again from [Shape Browser].

### ◆ Axis Divisions

Here, the Tank Graph's divisions are entered if the graph is a division type. When no divisions are necessary, specify the number of divisions as 0.

Whether a Tank graph has divisions or not will vary depending on the Part Shape selected.

## ■ Tank Graph [Shape/Color] Attributes

Here, a Tank graph's border color, division color (Axis Color), data display color (Graph Color - Fg & Bg), as well as the data display pattern can all be selected.

**Reference** 2.1 Parts ■ *Selecting Colors*

## ■ Tank Graph [Alarm Settings] Attribute

If desired, Alarm Settings can be set here.

**Reference** 2.1 Parts ■ *Alarm Settings*



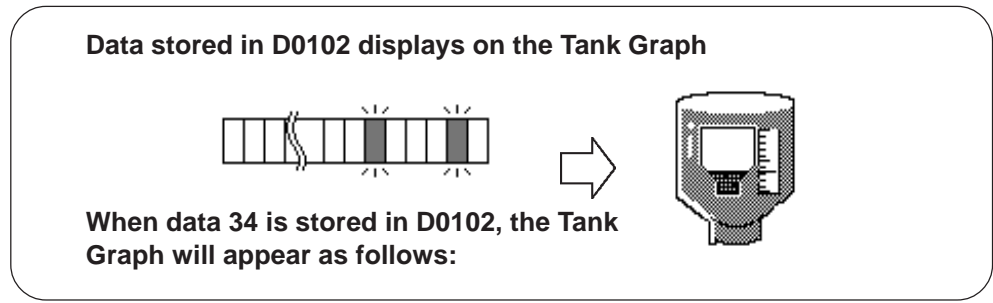

■ **Placing a Tank Graph**

The procedure for placing a Tank Graph is as shown below.

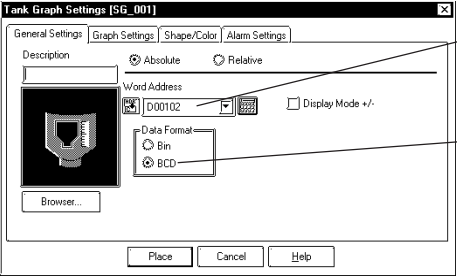

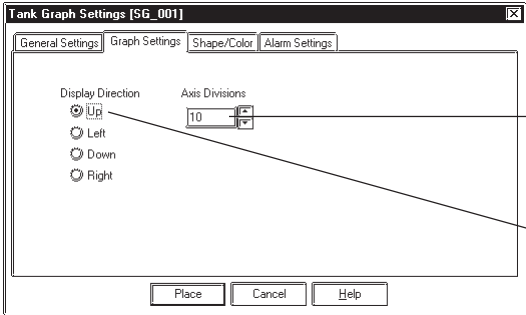
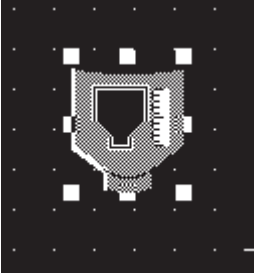
PROCEDURE	REMARKS
<p>(1) Select the [Parts] menu - [Tank Graph] command, or click on the  icon.</p> <p>(2) In the [General Settings] area, input the Word Address and Data Format.</p> <div style="display: flex; align-items: center;">  <div style="margin-left: 20px;"> <p>Enter D00102</p> <p>Select BCD</p> </div> </div> <p>(3) Select a Part Shape from the Browser. You can also use the Alarm Settings area to enter Alarm settings and select Colors, if desired.</p> <div style="display: flex; align-items: center;">  </div>	<p style="text-align: center;"><b>Reference</b> 2.1 Parts ■ <i>Selecting a Part Shape</i></p>

PROCEDURE	REMARKS
<p>(4) In the [Graph Settings] tab, input the number of axis divisions and graph data display direction.</p>  <p>Enter 10</p> <p>Select Up</p> <p>(5) After all of a Part's attributes have been entered or selected, click on the  button.</p> <p>The Tank graph's outline will appear on the Base screen, next to your cursor.</p> <p>(6) Click on the point where the Tank Graph's top left corner is to be placed.</p> <p>If desired, use the handles to alter its size.</p> 	<p>The Axis Divisions area will appear only for a graph type which has axis divisions.</p> <p>To cancel the placement, click on the  icon.</p> <p><b>Reference</b> To change the Part's size, refer to <b>2.4.3 Scaling Up/Down</b></p> <p>Double-clicking on any Part placed on the screen automatically calls up that Part's Attribute Settings dialog box.</p> <p><b>Reference</b> <b>2.4.14 Changing Attributes</b></p>

## 2.1.11 Meter Graphs

This Part creates an area where a device's Word Address' numeric data is displayed as absolute or relative values on a Meter Graph (i.e. a needle moves to show the value). The graph's display will change to reflect PLC Word Address data changes.

### ■ Meter Graph [General Settings] Attributes

<When displaying data in absolute values>

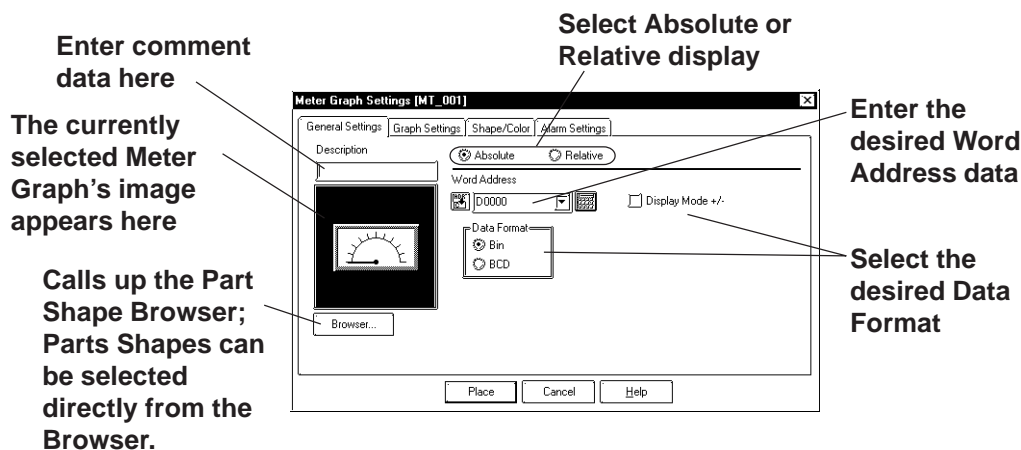

#### ◆ Absolute

Data stored in the designated Word Address is displayed as absolute values, from 0 to 100 (with Display Mode +/- selected, -100 to 100).

#### ◆ Word Address

Enter the Word Address where the data will be stored.

#### ◆ Data Format

Select the display data format from Bin and BCD.

#### ◆ Display Mode +/-

When this check box  is checked and Bin data format is selected, negative numeric data can be displayed.

<When displaying data in relative values>

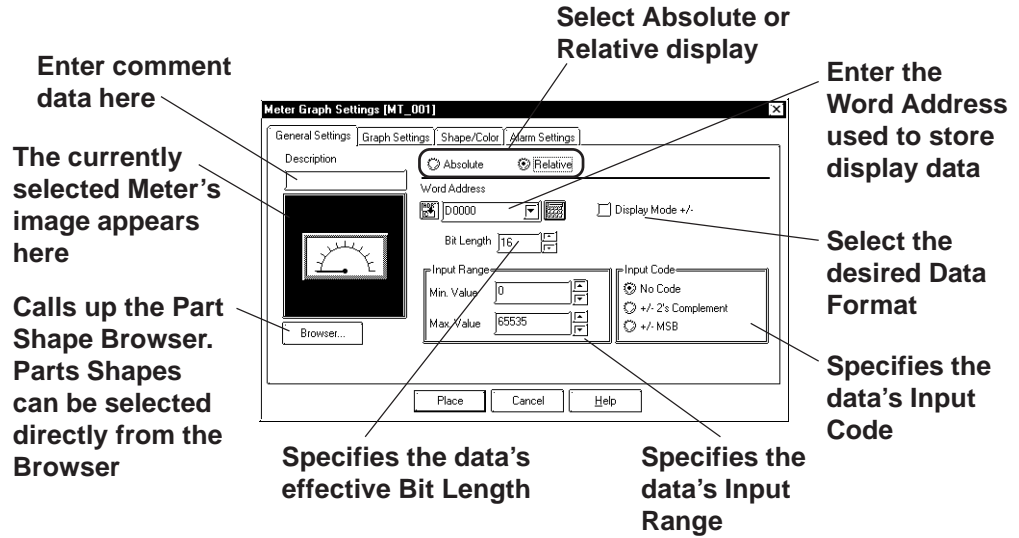

◆ **Relative**

The data stored in the Word Address are converted to a value between 0 and 100 according to the designated Input Range and displayed as relative values.

◆ **Word Address**

Here, enter the Word Address used to store Meter Graph data.

◆ **Display Mode +/-**

When this check box  checked, negative numeric data can also be displayed.

◆ **Bit Length**

Specifies the Bit Length of all data stored in the Word Address.

◆ **Input Range**

Specifies the data's Input Range.

◆ **Input Code**

With No Code selected, only positive numeric data can be entered. To enter negative numeric data, select either +/-2's Complement or +/-MSB.

## ■ Meter Graph [Graph Settings] Attributes

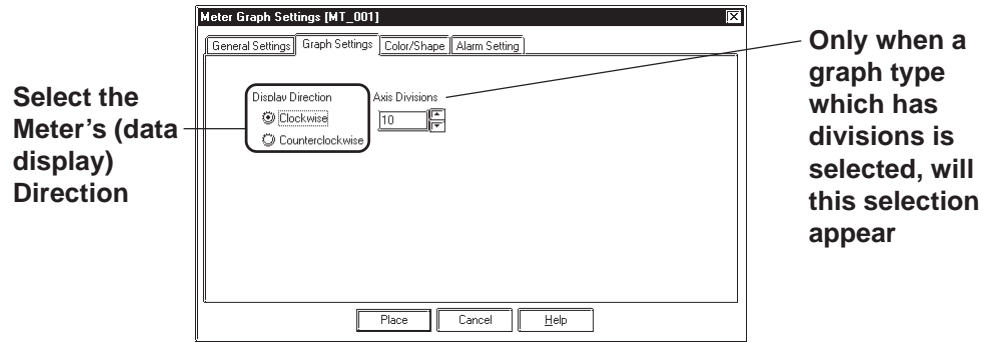

### ◆ Display Direction

Here, the Meter's display direction, either Clockwise or Counterclockwise can be selected.

### ◆ Axis Divisions

Here, the Meter increments are entered. If the number of Divisions is specified as 10, 11 division lines are displayed. When no divisions are necessary, simply enter "0".

## ■ Meter Graph [Shape/Color] Attributes

Here, a Meter's border color, division color (Axis Color), and needle color (Meter Color) can be selected.

▼ **Reference** ▲ 2.1 Parts ■ *Selecting Colors*

## ■ Meter Graph [Alarm Settings] Attributes

If desired, an Alarm's settings can be set here.



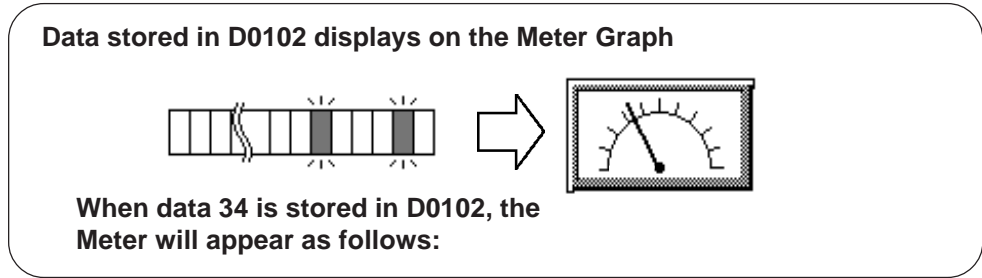

▼ **Reference** ▲ 2.1 Parts ■ *Alarm Settings*

■ **Placing a Meter Graph**

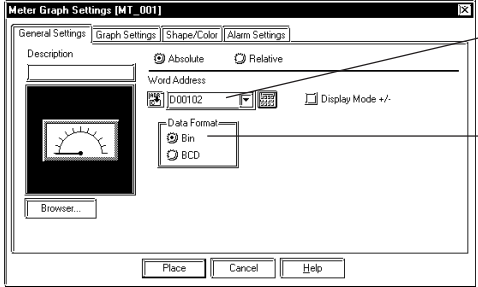
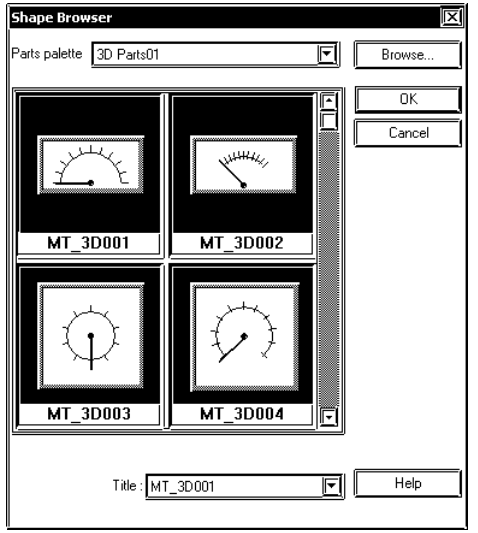
The procedure for placing a Meter Graph is as shown below.

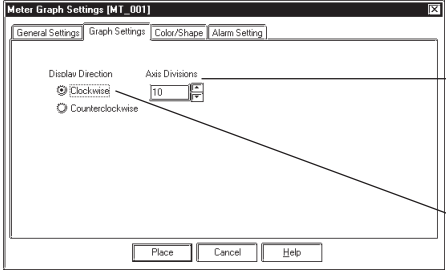

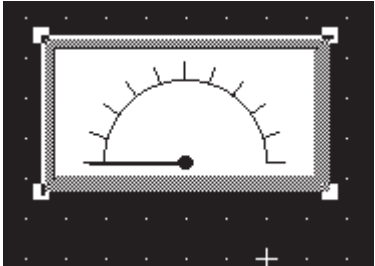
PROCEDURE	REMARKS
<p>(1) Select the [Parts] menu - [Meter Graph] command, or click on the  icon.</p> <p>(2) In the [General Settings] area, input the Word Address and Data Format.</p> <div style="display: flex; align-items: center;">  <div style="margin-left: 20px;"> <p>Enter <b>D00102</b></p> <p>Select <b>Bin</b></p> </div> </div> <p>(3) Select a Part Shape from the Browser. You can also use the Alarm Settings area to enter Alarm settings and select Colors, if desired.</p> <div style="display: flex; align-items: center;">  </div>	<p style="text-align: center; font-weight: bold; color: red;">▼ Reference ▲</p> <p style="text-align: center;">2.1 Parts ■ <i>Selecting a Part Shape</i></p>

PROCEDURE	REMARKS
<p>(4) In the [Graph Settings] area, input the number of divisions and data display direction.</p>  <p>(5) After all of a Part's attributes have been entered or selected, click on the  button.</p> <p>The Meter Graph's outline will appear on the Base screen, next to your cursor.</p> <p>(6) Click on the point where the Meter Graph's top left corner is to be placed.</p> <p>If desired, use the Meter Graph's handle to alter its size.</p> 	<p>The Axis Divisions will appear for a Meter Graph type which has axis divisions.</p> <p>To cancel the placement, click on the  icon.</p> <p><b>Reference</b> To change the Part's size, refer to <b>2.4.3 Scaling Up/Down</b></p> <p>Double-clicking on any Part placed on the screen automatically calls up that Part's attribute settings.</p> <p><b>Reference</b> <b>2.4.14 Changing Attributes</b></p>

**2.1.12 Trend Graphs**

This Part displays Word Address numeric data as absolute values on a Trend (line) graph. The graph's display will then change to reflect Word Address data changes.

**■ Trend Graph [General Settings] Attributes**

Enter comment data here

The currently selected Trend Graph Shape appears here

Calls up the Part Shape Browser, displaying a list of pre-made Trend Graph Shapes. Part Shapes can be selected directly from the Browser.

Select the desired Data Format

**◆ Data Format**

Here, the display data format is specified as either Bin or BCD. With the Display Mode +/- check box  checked, and Bin data format selected, negative numeric data can also be displayed.

**■ Trend Graph [Graph Settings] Attributes**

Select a graph type

Select the data display direction

Saves the previous data of the graph to the backup SRAM.

Enter the number of X and Y divisions

When "Scale" is checked, you can specify the range of data displayed with the trend graph (display range).

Enter the No. of Samples, Scroll value, and Sampling Time

Displays the previous data.



◆ Graph Settings

**Using “Normal”:** The specified Word Address’s data changes are displayed over time in a Trend Graph. Display data always starts at the “0” point. As each (time) sampling period elapses, the latest data is added in the specified display Direction. When the graph’s poly (gonal) line reaches the limit of the Trend Graph, the graph is shifted in the display Direction for the number units specified in “Scroll”.

E.g.) Display Direction: Right, Scroll Count: 4

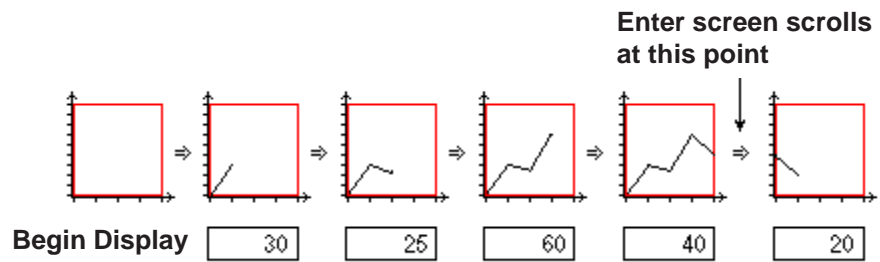

**Using “Pen-Recorder”:**

A specified Word Address’s data changes are displayed over time in a Trend Graph. The data’s display always begins with “0”. As each sampling period elapses, the graph’s poly(gonal) line is shifted one division opposite the specified display Direction. The latest data is always displayed at the very limit (in this example, the right side) of the Trend Graph’s display area.

E.g.) Display Direction: Right

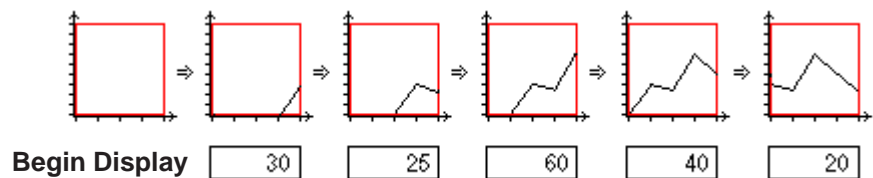

■ **Block (Display Mode)**

All the data in consecutive word addresses are sampled at the designated time, then graphed as a single trend line. Data changes in multiple word addresses can be monitored as a single block by the graph. Enter address numbers to control the ON/OFF display of the graph.

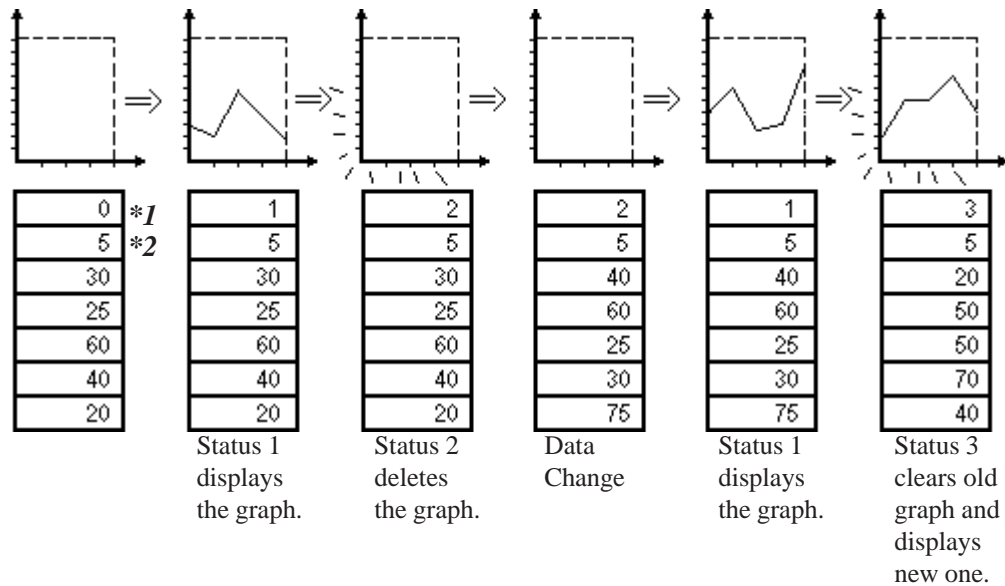

\*1 Control Status (address for controlling display)

\*2 Number of address data to display

▼ **Reference** For details of each graph type, refer to *Tag Reference Manual, 2.31 Trend Graph Display.*

◆ **Data Samples**

**Data Samples:** The number of data “units” to be displayed in a single Trend Graph. Up to 638 can be used.

**Scroll:** The number of data units to be scrolled when the polygonal line reaches the limit of the Trend Graph’s display area.

**Sampling Time:** The data read interval (from the device) is input in seconds. The field is enabled when the graph type is designated as "Normal" or "Pen-Recorder". This option cannot be specified when the graph type is designated as "Block".

◆ **Display Direction**

Select the Trend Graph’s display direction, either Up, Left, Down, or Right.



If [Display Direction] is changed for a 3D part, its shade is rotated along with that part. To let the shade displayed properly, click on the  button, and select the part again from [Shape Browser].

◆ **Axis Scale**

Enter the number of units that the X and Y axes are to be divided into. When no divisions are necessary, input "0".

◆ **Backup**

**Graph Backup:** Trend graph data displayed for each trend graph screen is backed up in the GP. The graph types that can be backed up are "Normal" and "Pen Recorder". When backing up only trend graphs in 32K bytes of backup SRAM, approximately 12 trend graphs of 639 pieces of display data each can be saved.



**Note:** This function is valid only for the GP models with back up SRAM. GP models with back up SRAM can be recognized by the label attached to the GP's rear face. When the GP70 series unit's label color is copper brown, the unit has back up SRAM. GP-377, GP-77R and GP2000 series units all have backup SRAM.

SRAM Seal

<b>Pro-face</b>	GRAPHIC PANEL
GP571-TC11	
S/N 8800150000	
DIGITAL ELECTRONICS CORP.	
MADE IN JAPAN	

◆ **Synchronous Mode**

When the power is turned back ON by selecting the Synchronous Mode, you can start drawing trend graph at the point where you stopped. If this mode is not selected, the trend graph data starts from the beginning.

◆ **Previous Data Display**

The previous data record of the trend graph can be displayed. This function is supported only by GP2000 Series units and is available when the graph type is designated as "Normal" or "Pen-Recorder". Enabling "Data Record Display" automatically enables the "Backup" option. The previous data record is saved in the GP's backup SRAM.

▼ **Reference** ▲ *Tag Reference Manual, 2.31 Trend Graph Display*

**Sampling Count**

Designate the quantity of sampling data to be stored in each channel. Enter the total value of the quantity of sampling data being displayed on the trend graph (current) and the cumulative quantity of sampling data (previous). Confirm that the Sampling Count is greater than the value of the Display Data Amount. The display can be made to return further than the trend graph data that are being displayed on the GP. Select "Bin" as the Display Format and enter a value between 1 and 65,238.

**Automatically Placed Switches**

These are function switches automatically placed on the right of the Trend graph parts for display of Previous Data. When using these switches, be sure to enable all switches. All switches are enabled with the initial settings.

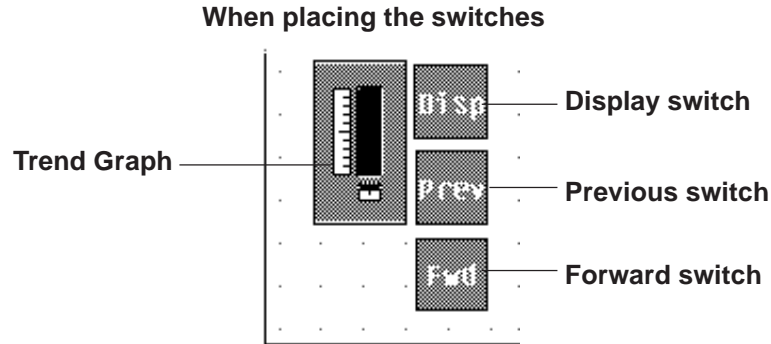

**Display (Disp)**







Switches to the trend graph to the Data Record Display mode.

Touching the  key switches to the Data Record Display mode and displays the switch in inverse video. When the switch is touched again, the inverse video is reset, and the Data Record Display mode is canceled.

**Previous (Prev)**



This switch is enabled only while the Data Record Display mode is ON (when the  switch is displayed in inverse video). (The  switch will not function even if it is touched while the  switch is not shown in inverse video.)



Touching the  switch displays the previous data by scrolling (backward) the data by a predetermined number of data items.

The number of data items to be scrolled can be designated between 1 and 65,238.

If the switch is touched while the last (oldest) data are displayed, the buzzer sounds three times. The display cannot be scrolled further.

**Forward (Fwd)**



This switch is enabled only while the Data Record Display mode is ON (while the  switch is displayed in reverse video). (The  switch will not function even if it is touched while the  switch is not shown in reverse video.)

Touching the  switch displays the data by scrolling the previous data up to the end point, which is the most recent data at the moment the display mode is switched to the Data Record Display. The number of data items to be scrolled can be designated between 1 and 65238.

When the switch is touched while the most recent data (at the moment the display mode is switched to Data Record Display) are displayed, the buzzer sounds three times. The display cannot be scrolled further.

**Browser** Displays the browser. The Part shape can be selected on the browser. **▼Reference▲ 2.1 Parts ■Selecting a Part Shape**

#### **Border Color/Color/Pattern**

Select the border color of the switch (Border color), color of the switch (Color), and the pattern of the switch (Pattern). **▼Reference▲ 2.1 Parts ■Selecting Colors**

#### ◆ **Display range**

When "Scale" is checked, you can specify the range of data displayed with the trend graph (display range).

Enter the upper and lower limit values of the data using direct/indirect addressing.

This function is effective only with the GP2000 Series when the graph type is designated as "Block Display".

When "Scale" is checked, specify the type and line type of the assistant line in the [Assist Line] tab.

**▼Reference▲ Tag Reference Manual 2.31 Trend Graph Display**

- Scale** : Enables the settings for designating the display range of the data in a "Block Display" type trend graph or for specifying the details of the assistant line.
- Upper/Lower** : Designate the upper and lower limit values directly or indirectly.
- Direct** : Designate the range directly. Values can range between 0 and 65535 or, when a negative value is used, between -32768 and 32767.
- Indirect** : Designate the range with word addresses.



- **The display range is fixed to 16 bit and BIN.**
- **Data exceeding the designated display range is not displayed.**
- **When the display range setting is changed, the updated trend graph is displayed only after the graph display has been cleared or the screen has been switched.**

## ■ Trend Graph [Channel Setting] Attributes

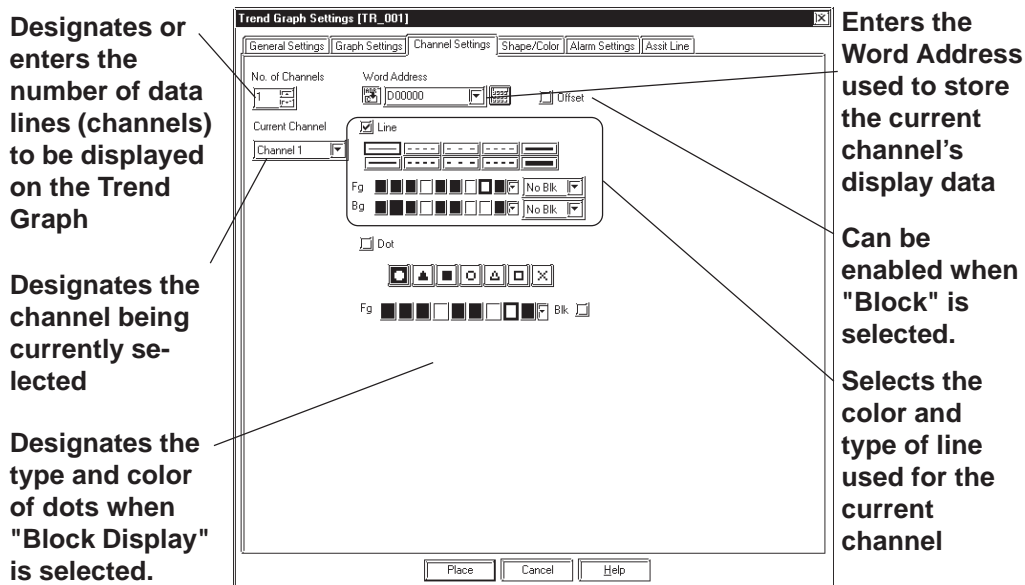

### ◆ Number of Channels

Enter the number of channels used in the Trend Graph. Use the "Current Channel" area to select which channel is being specified. The maximum number of channels that can be set up for the entire Project file (PRW file) is 40 with GP2000 series units and 20 with other models. (When Data Sampling is designated, the quantity of data sampling is included.)

### ◆ Word Address

Enter the Word Address used to indicate where the Trend graph's data is stored.

**Reference** For details of the Word Address for block display when the graph type is designated as "Block" in the [Graph Settings] area, refer to *Tag Reference Manual, 2.31.5 Block Display Mode (for Device Direct Access)*.

### ◆ Offset

This function can be selected when "Block" is selected as the graph type on the Graph Settings tab. The address in which graph data are stored can be designated as Offset. The Offset setting becomes valid when the device Word Address is used as the Word Address. **Reference** *Tag Reference Manual, 2.31.5 Block Display Mode (for Device Direct Access)*.

### ◆ Line

Specify the type and color of the line in the trend graph.

### ◆ Dot

Specify the type and color of the dots when the data is displayed in dots. This function is available only with the GP2000 Series units. This option is active only when the graph type is set to "Block Display". This option cannot be used together with the "Fill Below Line" option of the trend graph.

■ Trend Graph [Shape/Color] Attributes

The Trend Graph's border color, division color (Axis Color), and Trend Graph's display area color (Graph Area Color) can be selected.

▼ **Reference** ▲ 2.1 Parts ■ *Selecting Colors*

■ Trend Graph [Alarm Settings] Attributes

If desired, an alarm's settings can be set here.

▼ **Reference** ▲ 2.1 Parts ■ *Alarm Settings*

■ Trend Graph [Assist Line] Attributes



• Options for the assistant line can be set only when "Block Display" and "Scale" are selected in the [Graph Settings] tab.

◆ Draw Line

Click the desired assistant line button -  ,  or  - and check "Line". You can now specify the position (direct/indirect addressing), type and color of the selected assistant line.

▼ **Reference** ▲ *Tag Reference Manual 2.31 Trend Graph Display*

**Data stored in D0102 is displayed on the Trend Graph**

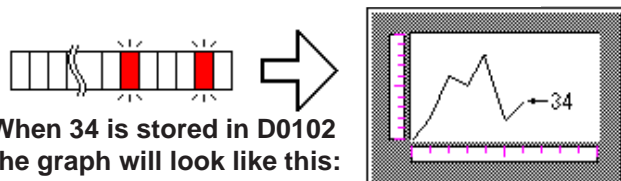

When 34 is stored in D0102 the graph will look like this:

Axis Settings  
 \* Sample 20  
 \* Scroll 19  
 \* Sampling Time 10 sec  
 \* Axis Div. (Ver.) 10  
 " " (Hor.) 10

PROCEDURE	REMARKS
-----------	---------

(1) Select the [Parts] menu - [Trend Graph] command, or click on the  icon.

(2) After clicking on the [General Settings] tab, select the data format.

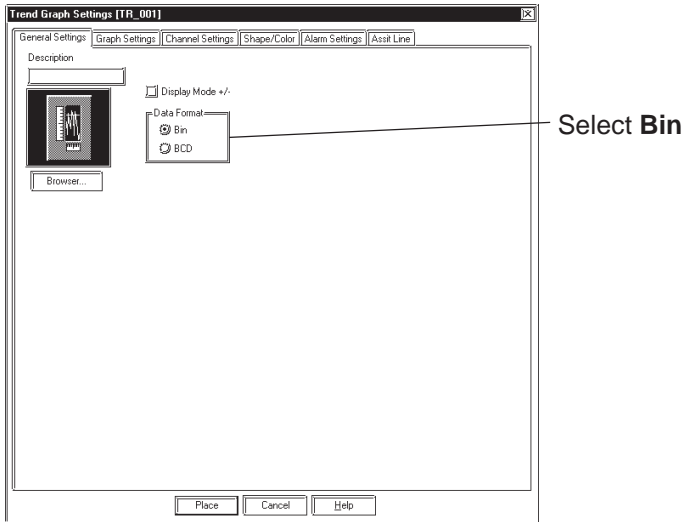

Select Bin

Data in the range of 0 to 100 can be displayed on the Trend Graph. When the data range is from -100 to 100, check the Display Mode +/- check box.

(3) Select a Part Shape from the Browser. You can also use the Alarm Settings area to enter Alarm settings and select Colors, if desired.

**Reference** 2.1 Parts ■ Selecting a Part Shape

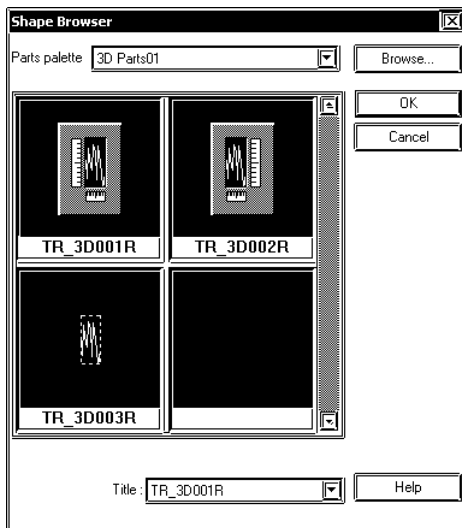



PROCEDURE	REMARKS
-----------	---------

**(4) In the [Graph Settings] area, select the Graph Type and Direction, and enter the number of Data Samples and Axis Divisions.**

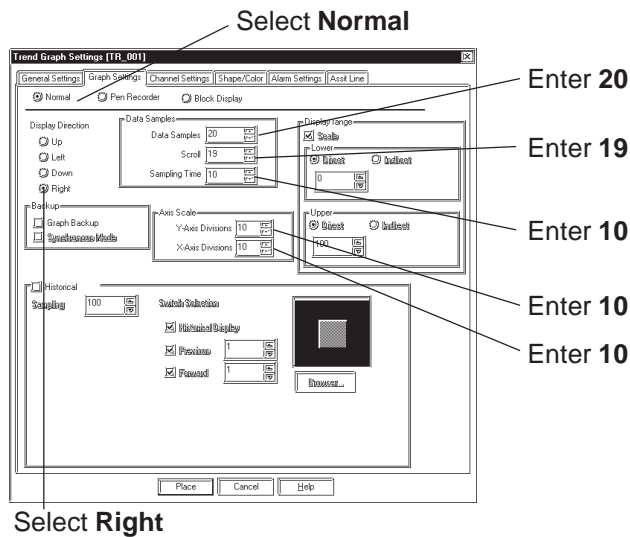

When "Block" is selected as the graph type, the "Data Record Display" setting is disabled.

The "Display range" settings can be designated when the graph type is set to "Block Display".

**[When Data Record Display Setting is Disabled]**



**(5) In the Channel Setting area, enter the Number of Channels, then enter each channel's Word Address and select the desired colors.**

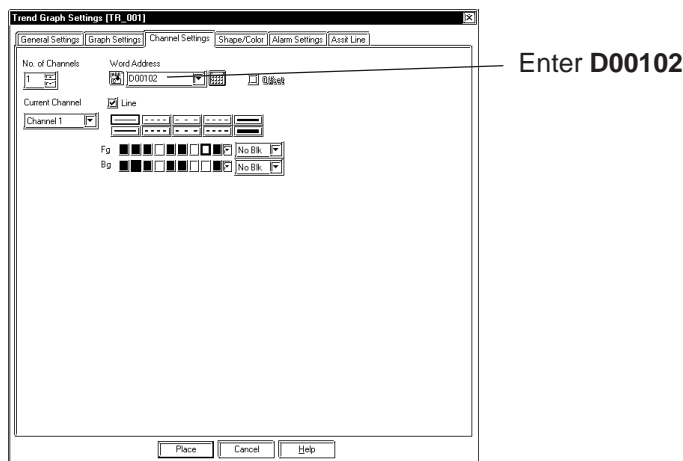



In this example, since the Number of the Channels is "1", you only need to enter one Word Address.

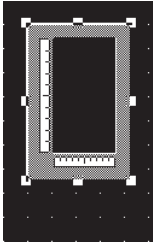

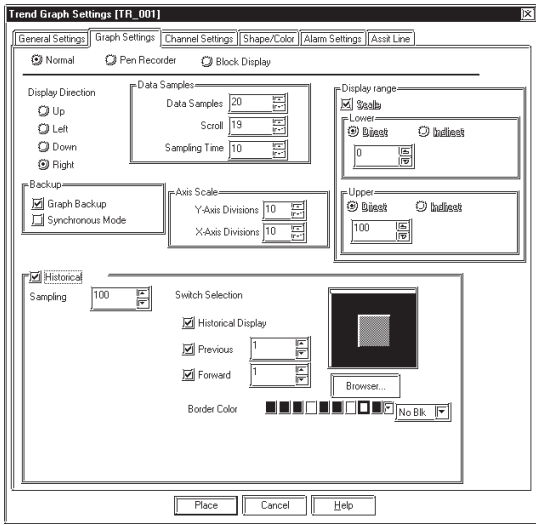
If the more than one channel is used, be sure to enter the Word Address and select the Color for each channel before placement.

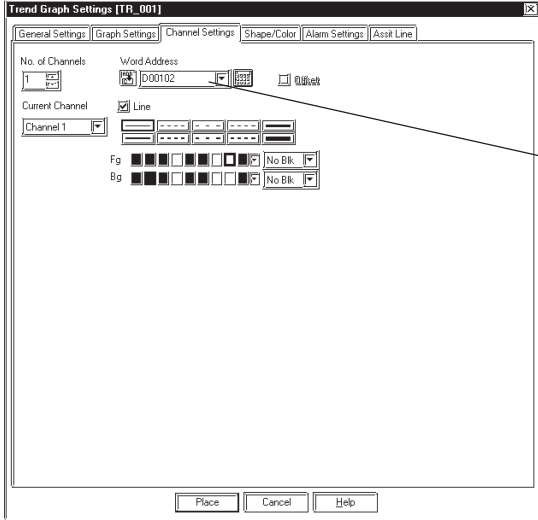
For parts using two or more word addresses and trend graph channels, confirm that the word addresses will not overlap; otherwise, an error may occur in the GP.

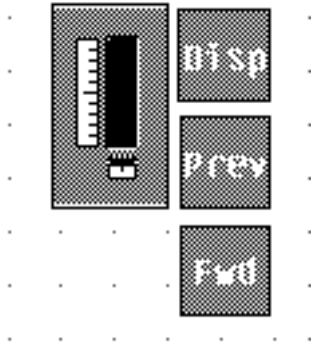
PROCEDURE	REMARKS
<p>(6)After all of Part’s attributes have been entered or selected, click on the  button.</p> <p>The Trend Graph’s outline will appear in the Base screen, next to your cursor.</p> <p>(7)Click on the point where the Trend Graph’s top left corner is to be placed.</p> <p>If desired, use the Trend Graph’s handles to alter its size, after placement.</p> 	<p>Up to 20 channels can be designated for a Project file (including the Data Sampling frequency number) is 40 with the GP2000 series units, and 20 with the other models.</p> <p>Up to 8 Trend Graph display areas can be placed on a single screen. Data Record Display can be set up to only one of those trend graphs.</p> <p>To cancel the placement, click on the  icon.</p> <p>To change a Part’s size, refer to <b>Reference 2.4.3 Scaling Up/Down</b></p> <p>Double-clicking on any Part placed on the screen automatically calls up that Part’s attribute settings.</p> <p><b>Reference 2.4.14 Changing Attributes</b></p>
<p>[When Data Record Display Setting is Enabled]</p> <p>(5)Put a check mark in the Data Record Display checkbox.</p> <p>In this example, since the Number of the Channels is “1”, you only need to enter one Word Address.</p> 	<p>Checking the Historical checkbox automatically calls up the Backup settings.</p> <p><b>Reference</b> For details on Historical Display and Backup functions, refer to <i>Tag Reference Manual, 2.31 Trend Graph Display.</i></p> <p>In the initial settings for the default switches (automatically placed switches), Historical Display, Previous and Forward are all enabled. When using switches, place a check mark in every checkbox.</p>

PROCEDURE	REMARKS
<p><b>(6) In the Channel Setting area, enter the Number of Channels, then enter each channel's Word Address and select the desired colors.</b></p> <p>In this example, since the Number of the Channels is "1", you only need to enter one Word Address.</p>  <p><b>(7) After all of Part's attributes have been entered or selected, click on the  button.</b></p> <p>The Trend Graph's outline will appear in the Base screen, next to your cursor.</p> <p><b>(8) Click on the point where the Trend Graph's top left corner is to be placed.</b></p> <p>If desired, use the Trend Graph's handles to alter its size, after placement.</p> 	<p>If the more than one channel is used, be sure to enter the Word Address and select the Color for each channel before placement.</p> <p>For parts using two or more word addresses and trend graph channels, confirm that the word addresses will not overlap; otherwise, an error may occur in the GP.</p> <p>Up to 20 channels can be designated for a Project file (including the Data Sampling frequency number) is 40 with the GP2000 series units, and 20 with the other models.</p> <p>Up to 8 Trend Graph display areas can be placed on a single screen. Data Record Display can be set up to only one of those trend graphs.</p> <p>To cancel the placement, click on the  icon.</p> <p>The trend graph with the default switches (automatically placed switches) has been grouped. To change its size or attributes, ungroup it first by clicking on the  icon.</p> <p><b>Reference</b> <a href="#">2.4.12 Group/Ungroup</a>, <a href="#">2.4.3 Scaling Up/Down</a>, <a href="#">2.4.14 Changing Attributes</a></p> <p>Only one trend graph part with the Data Record Display setting can be placed on each screen. Do not place a function switch designated with the "Trend Key" setting in the same screen on which a function switch has been automatically placed on the screen.</p>

**2.1.13 Keypads**

Here, pre-made keypads are used to enter data to a designated Word Address. In order to input data via the keypad, it is necessary to first create a Keypad Input display.

**Reference** 2.1.14 Keypad Display

**Keypad [Description] Attributes**

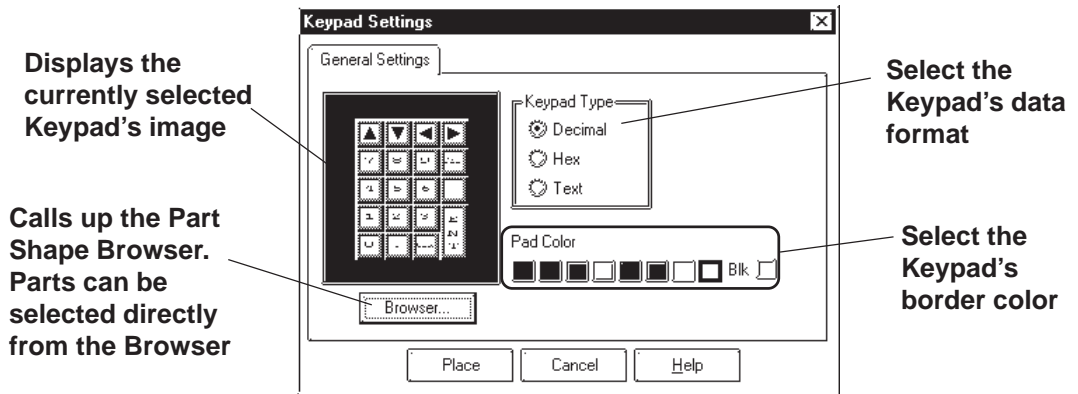

**Keypad Type**











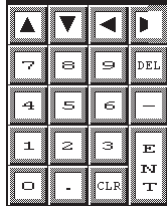
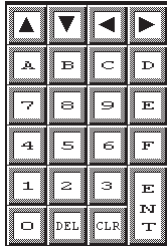



First, a Keypad type needs to be selected that will be suitable for the data format specified. To select a Keypad type, simply click on the Browser and the selection of available Keypads will be displayed.

**Pad Color**

The Keypad's border color (Pad Color) can be selected here.

■ Keypad Key Functions

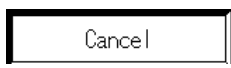
The various Keypad Key functions are shown in the table below.

	Decimal	Hexadecimal	
Keypad Specs			
Common Keys	 - 	<b>Numeric value keys</b> (for Hex, the keys are 0 to F). Inputs the corresponding value in the display.	
		<b>Delete key</b> Deletes the character above the cursor.	
		<b>Clear key</b> Clears the entire display. If the  is pressed after clearing, 0 is stored in the Device Word Address.	
		<b>Enter key</b> Registers the set value and writes it to the Device Storage Address. Then, the cursor moves to the next display and awaits next input.	
	 	<b>Cursor keys</b> Moves the cursor right and left within the display.	
	 	<b>Jump keys</b> Moves to the next Key Display without entering the set value. You can use these keys to jump to the area where you wish to enter data.	
	<b>Dec. Only keys</b>	<b>Dec. / Text Only keys</b>	
		/	
			
			Cancels the set value. When using Keypad Display's Pop-up Keypad, the Pop-up Keypad closes without registering the input value.
			Cancels the set value. When using Keypad Display's Pop-up Keypad, the Pop-up Keypad closes without registering the input value.

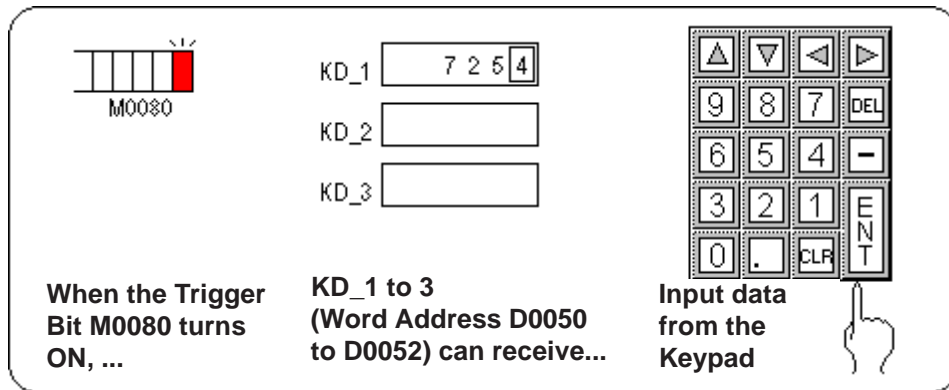

■ **Placing a Keypad**

The procedure for creating and placing a keypad is shown below.

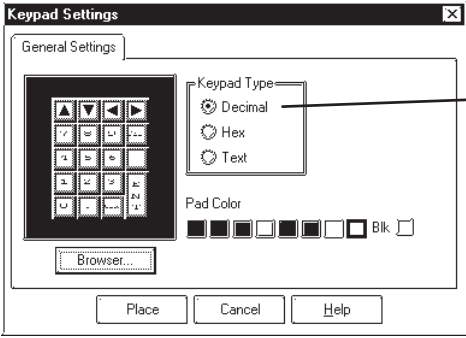
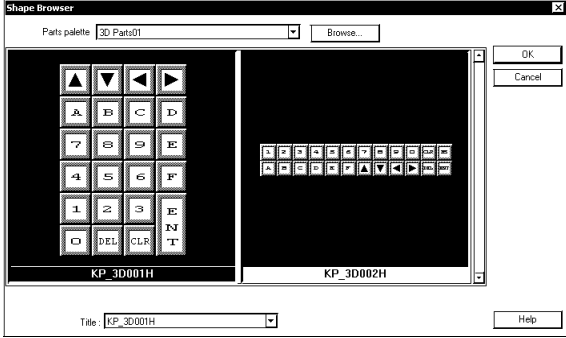

▼ **Reference** For how to create the display area for the keypad shown here, refer to **2.1.14 Keypad Display**.

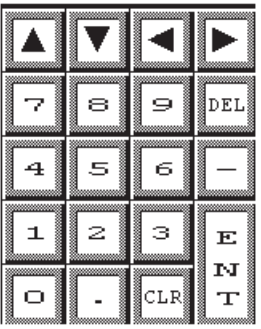
PROCEDURE	REMARKS
<p>(1) Select the [Parts] menu - [Keypad] command, or click on the  icon.</p> <p>(2) Select a Keypad Data Format Type.</p>  <p>(3) Select a Keypad Shape from the Browser. If desired, select a color from the Shape/Color area.</p> 	<p>▼ <b>Reference</b> 2.1 Parts ■ <i>Selecting a Part Shape</i></p>

PROCEDURE	REMARKS
<p>(4)After all of the Keypad’s attributes have been entered or selected, click on the  button. The Keypad’s outline will then appear in the Base screen, next to your cursor.</p> <p>(5)Click on the point where the Keypad’s top left corner is to be placed.</p> 	<p>To cancel the placement, click on the  icon.</p> <p>Double-clicking on any Part placed on the screen automatically calls up that Part’s attribute settings.</p> <p><b>Reference</b>  2.4.14 <i>Changing Attributes</i></p>



- Regular Keypad parts have all been previously grouped. Therefore, to create a new keypad, simply un-group the Keypad and arrange the pieces as you like.

**Reference**  2.4.12 *Group/Ungroup*

- The pre-made Keypad Input Displays that support the User-assignable input order feature are KP\_3D005D, KP\_3D006D, KP\_PL004D, KP\_3D004H, KP\_3D005H, and KP\_PL003H.

**Reference**  2.1.14 *Keypad Display*

**2.1.14 Keypad Display**

This section describes the procedure for creating an area for displaying the data input from the keypad.

Touching the Keypad Input Display can automatically call up a pop-up keypad. When not using the pop-up keypad, place an additional keypad separately from the Keypad Input Display.



- A pop-up keypad is automatically set when the Keypad Input Display [Popup] selection is set to [Exists]. Setting up an additional keypad is not required.
- K-tag functions can be set up (except for the operation function). Also see "2.12 K Tag (Key Input)" in the Tag Reference Manual.
- The Keypad Input Display cannot be set up simultaneously with the CSV Display, Logging Display or N699-tag.



**The pop-up keypad is available only with GP-377, GP77R and GP2000 Series units.**

**■ Keypad Display [General Settings] Attributes**

These items trigger the Keypad Input Display to accept input.

Enter the Word Address used to store display data

Enter comment data here

The currently selected Part's image will appear here

Calls up the Part Shape Browser. Parts can be selected directly from the Browser

When this is enabled/selected, the input cursor will move in the designated order and then wait in the next field. If the same Group number is entered, the cursor will move as designated in the Group. Available only with GP2000 Series units.

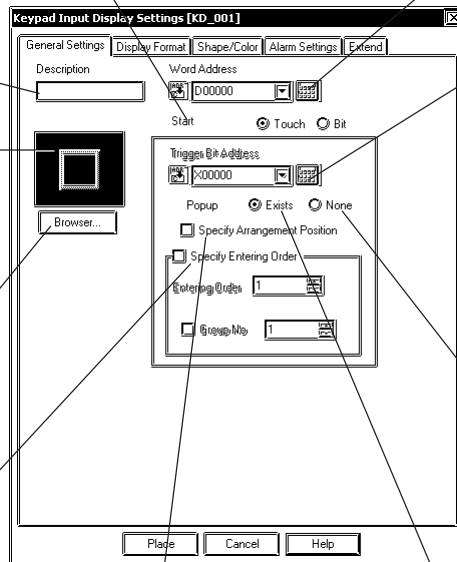

When this is selected/enabled, you can designate the location (coordinates) where the Popup Keypad will appear. Available only with GP2000 Series units.

If [Exists] is selected, touching the Keypad will automatically display a data entry keypad.

When "Bit" is selected for the "Start Input" option, enter the trigger bit for making the Keypad enter the waiting mode for key input. Use a keyboard for key entry, and enter the data.

If [None] is selected, touching the Keypad Input Display waits for input. Use a numeric input keypad part. Available only with GP2000 Series units.



◆ **Word Address**

The Word Address is used to store the keypad display's data.

◆ **Start****[Bit]**

When the designated Start Bit turns ON, the cursor moves to the designated input area and waits for input.

For the setting example:  ■ *Using a Keypad to Input Values*

◆ **When using [Bit] method for data input****[Touch]**

When the Keypad Input Display is touched, the input field's color will reverse and wait for input. The Start Bit Address is disabled.

◆ **Popup [Exists]**

When the Keypad Input Display is touched, the data entry Keypad will appear.

If [Exists] is selected, after the Input Display is placed on the screen, the popup keypad's position can be designated. If this feature is not selected (disabled), touching the Keypad Input Display automatically displays the popup keypad.

For a setting example:  ■ *Using a Keypad to Input Values*

◆ **Keypad Input Display's [Touch] feature is Selected/Enabled ([Specify Entering Order] is disabled)**

- The popup keypad is available only on GP-377, GP77R and GP2000 Series units.
- The popup keypad designation feature is only available if the Popup item [Exists] is selected.

◆ **Popup [None]**

When the Keypad Input Display is touched, the Keypad Input Display automatically enters a "wait" condition for input. If a numeric data entry keypad is placed on the screen, data entry is possible. For keypad creation examples,  2.1.13 Keypads

For a setting example:  ■ *Using a Keypad to Input Values*

◆ **When using [Touch] method for data input (Popup Keypad is disabled) ([Specify Entering Order] is selected)**

- The popup [None] feature is available only on GP2000 Series units.

◆ Specify Entering Order

When this feature is selected/enabled, the input order of the cursor follows the order selected here and waits in the designated place for data entry. [Entering Order] can be from 1 to 255. If [Group No] is selected and a group number is entered, the data entry cursor's movement order will follow that of the other Keypad Input Displays registered to that group. Group No can be any number from 1 to 10.



- The [Specify Entering Order] feature is available only on GP2000 Series units.
- When only the data input order is designated, Group No "0" is recognized. Any Input Displays set for "0" will operate normally on the GP.

■ Keypad Display [Display Format] Attributes

When selected, the address storing the data to be displayed is specified indirectly.

The decimal point is not included in the display digits. Enter the No. of Display Digits

Enter the No. of Digits after the decimal point

Select the data to be displayed. **Reference** Tag Reference Manual, 2.12 K-tag (Key Input)

Select the Data Length and Data Format here.

Character size can be selected here

◆ Absolute

Handles 16-bit or 32-bit data. **Reference** Tag Reference Manual, 2.12 K-tag (Key Input)

Also designate the Data Format, Code, and Data Length of the data to be displayed.

When "Dec" is selected, put a check mark in the "Code +/-" checkbox to enable display of negative data values.

◆ No. of Display Digits

Here, the number of digits displayed, to the right of the decimal point, is input.

◆ Decimal Places

Here, the number of digits to the right of the decimal point is input.

When using 32 bit data, the relationship between the top and bottom of the Word Address will differ depending on the device used.

**Reference** Device (PLC Connection) Manual



**Note:** When the No. of Display Digits is set to 5 and the Decimal Places is set to 2, a value appears on the Keypad Input Display as shown below.

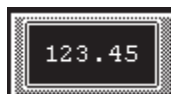

Even if the Display & Write Data Format is set to BCD, "." and "\_" are displayed on the Popup Keypad. Set the Alarm Settings to prevent "." and "\_" from entering.

**Reference** *Tag Reference Manual, 2.12.5 Notes on Entering BCD Data Keypad Display Input [Alarm Settings] Attributes*

#### ◆ Character Size

The label's character size is selected here.

**Reference** *2.2.9 Text*

#### ■ Keypad Display [Color/Shape] Attributes

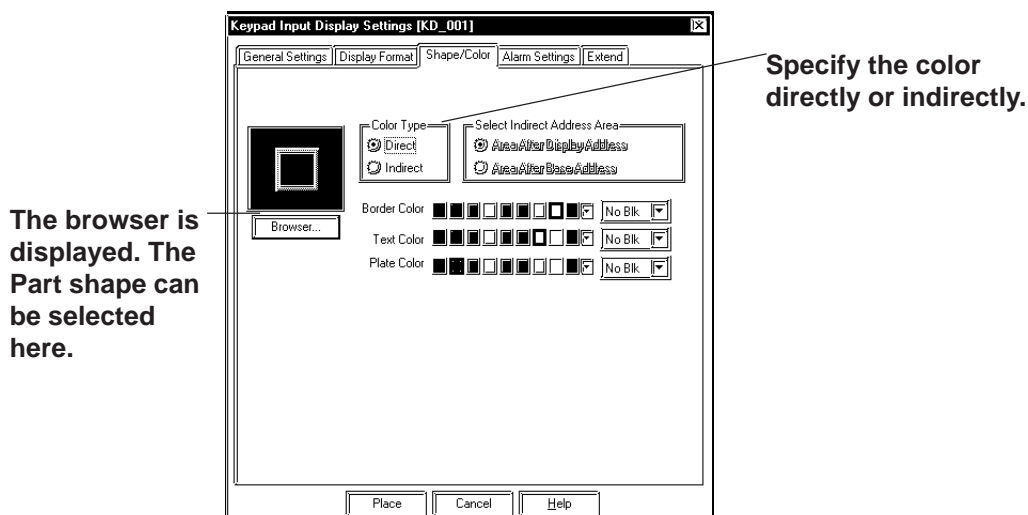

The Keypad Display's border color, data display color (Text), and interior color (Plate) are selected here.

#### ◆ Color Type

**Direct** Directly designates the color settings.

**Indirect** This option is enabled when the Data Format is set to "Absolute" and the Alarm is set to "OFF". The Text color and Plate color settings can be designated indirectly. Designate the color attributes to the address displayed right under the "Text color" and "Plate color". Note that this setting is not available with the GP270. **Reference** *Tag Reference Manual, 2.10.4 H-tag/ Object Drawing Data/Color attributes*

#### ■ Keypad Input Display [Alarm Settings] Attributes

Set up alarms if necessary.

**Reference** *Tag Reference Manual, 2.12 K-tag (Key Input)*

## ■ Keypad Display [Extend] Attributes

Use this tab to designate the Input Style, Display Style, and Interlock function.

**Supported by the GP2000 Series only**

**Specify the ON/OFF status of the Interlock function. (This function can be set up only when the pop-up keypad is used.)**

**Specify the Display Style.**

**This item designates the address used to store the Input status when Keypad Input Display data entry is completed. Available only on GP2000 Series units.**

### ◆ Input Style

#### • Auto Clear OFF

The previous input is not cleared and displayed in the input area. The new input is appended to existing data. To clear the existing values, enter "CLR" from the Touch Keypad.

#### • Auto Clear ON

The previous input is cleared when the first character (except the cursor keys, ENT, DEL and BS keys) is entered.

#### • Auto Clear & Input Check

When barcode input is performed in this mode, the Auto Clear function is enabled and the input data are monitored so that it matches the No. Display Digit. If the data length is inappropriate, it is not written into the word address. When data is input from the Touch Keypad, only the Auto Clear function is enabled.

#### • Barcode Input

Selecting this feature enables input from the Touch Keypad and barcode readers.

### ◆ Display Style

- Shift Left
- Shift Right

Select the display style from the Shift Left and Shift Right. The data will appear, starting from the side designated here. The Shift Left is selected by default.

- **Zero Suppress**

Select this option to omit the leading zeros of display data. E.g. When the Display Length is 4 and the Zero Suppress is NOT selected, 25 appears as 0025.

- **Zero Display**

When this option is clicked, and the Device data is 0, the value 0 will display.

- **7 Segment Display**

When this option is selected, numerical values are shown on a 7-segment display. Only the GP2000 Series supports the 7 Segment Display.

 **Note:** When a GP type other than the GP2000 Series is selected and the "7 Segment Display" option is enabled, the following alarm appears.

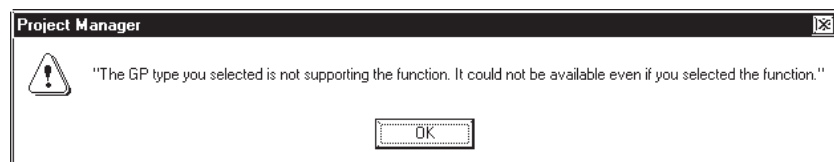

To clear the alarm, disable the "7 Segment Display" option.

- ◆ **Interlock**

Only when a bit designated via Interlock Address is in a state that has been selected via [Touch available condition], the pop-up keypad becomes effective. Whether the touch is effective in ON state or in OFF state is selectable here.

 **Note:** This function is available only with the GP-377, GP77R and GP2000 series.

Touch Available Condition	Interlock Address Status	Touch Available/Not Available
Bit ON	ON	Touch Available
	OFF	Touch Not Available
Bit OFF	ON	Touch Not Available
	OFF	Touch Available

 **Note:**

- If the [Interlock] feature's [Touch available condition] is deselected (disabled) while data is being input, data entry can still continue. However, the interlock feature will not operate.
- If, during data input the Interlock feature all the Input displays are activated, the data entry cursor will disappear and data cannot be input.

◆ **Input Completion**

This item designates the bit address used to store the input status when Keypad Input Display data entry is completed.

When [ENT] of the keypad on the GP's screen is touched, the designated bit address turns ON. Turn this bit OFF via control of the connected device.





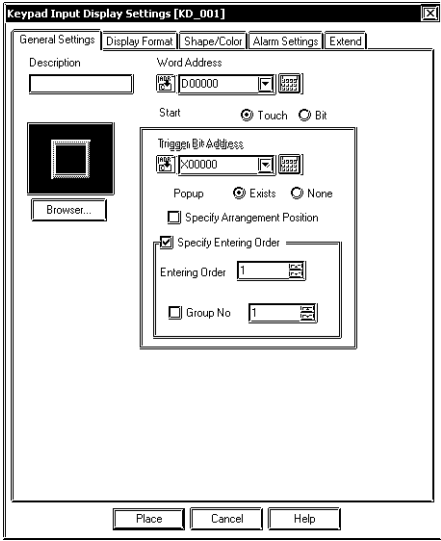

**Note:** This feature is available only on GP2000 Series units.

■ **Placing a Keypad Display**

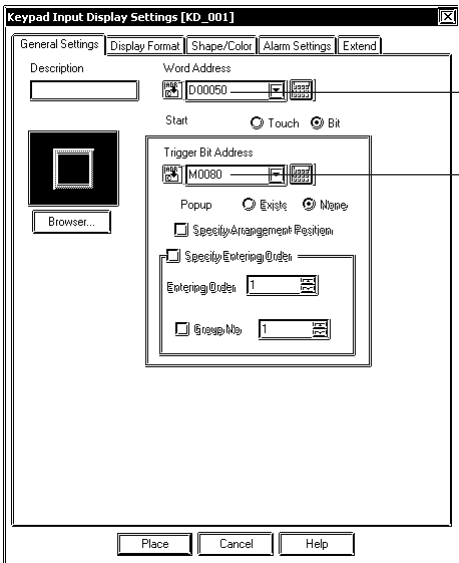
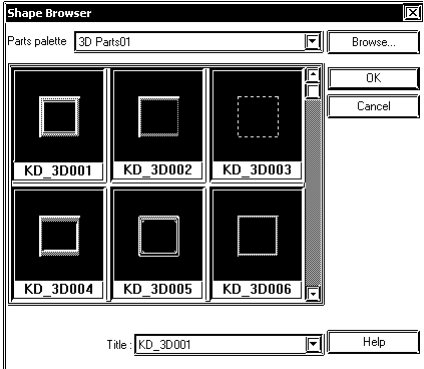
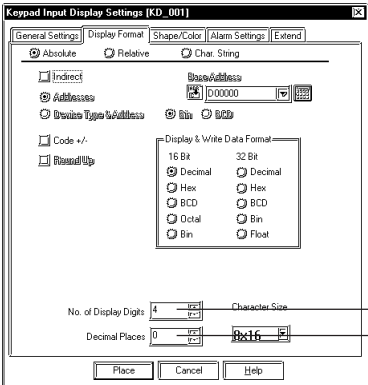
The Keypad Display's placement procedures are shown below.

PROCEDURE	REMARKS
<p>(1) Select the [Parts] menu - [Keypad Input Display] command, or click on the  icon.</p> <p>(2) Enter the following settings in the [General Settings] tab.                      Select to method used trigger the Keypad Input Display to accept input, i.e. either [Touch] or [Bit].                      [If Touch is selected]</p> <ul style="list-style-type: none"> <li>• <b>When using a Popup Keypad:</b>                              Select the Popup area's [Exists].                              If you wish to position the Popup Keypad in a specific location, select [Specify Arrangement Position].</li> </ul>  <ul style="list-style-type: none"> <li>• <b>When <u>not</u> using the Popup Keypad:</b>                              Select the Popup Area's [None].</li> </ul> <p>To set the Keypad Input Display's data entry cursor to move in the desired order, select [Specify Entering Order], and select the [Entering Order] and enter a value in the [Group No].</p>	<p>When Start is set to [Touch], the Trigger Bit Address will be grayed out (disabled).</p> <p>The [Specify Arrangement Position] feature is only available on GP2000 Series units.</p> <p>The [Specify Entering Order] feature is only available on GP2000 Series units. It is only available if the Start area's [Touch] is selected.</p>

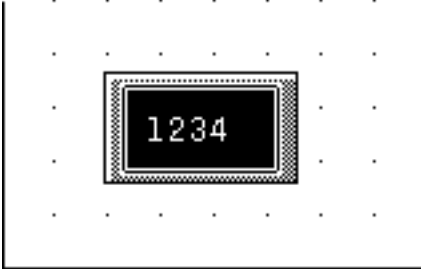
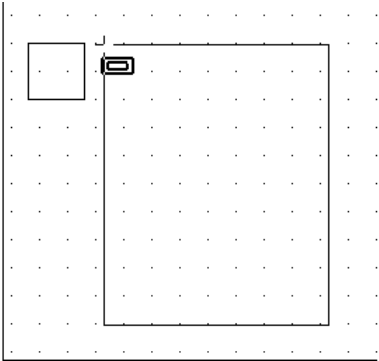
PROCEDURE	REMARKS
<p><b>[If Bit is selected]</b>  <b>Enter the Word Address and the Trigger Bit Address.</b></p> 	
<p><b>(3) Select a Part Shape from the Browser.</b>                      If desired, select colors from the [Shape/Color] area and input the extension settings.</p> 	<p><b>Reference</b> 2.1 Parts ■ <i>Selecting a Part Shape</i></p>
<p><b>(4) In the [Display &amp; Write Data Format] area, specify the Data Display Format, No. of Display Digits, and Decimal Places (i.e. number of the digits after the decimal point) to be used. If desired, select the Character Size.</b></p> 	<p>When using 16-bit device and [Absolute] for the Display Format, if [Indirect] is selected and 32 Bit is used for [Display &amp; Write Data Format], 2 words will be needed for the [Word Address] and the Word address which contains the data as indirect each.</p>

PROCEDURE	REMARKS
<p><b>(5) After all of the Keypad Display's attributes have been entered and selected, click on the  button.</b></p> <p>The Keypad Display's outline will appear on the Base screen, next to your cursor.</p> <p><b>(6) Click on the point where the Keypad Display's top left corner is to be placed.</b></p> <p>If desired, use the Keypad Display's handles to alter its size.</p> <p>Even though the set value display area is scaled up or down, the character size will not change. To change the character size or position, directly select the characters inside the border.</p>  <p>If a Keypad-type Input Display's [Specify Arrangement Position] is selected, after you click on the Keypad Input Display icon and select [Place], a Popup Keypad size border will appear. Simply click on the desired position on the screen and the keypad will be placed there. Click again to display the keypad's handles.</p>  <p><b>(7) Repeat from step (1) to create Keypad Displays with Word Addresses "D00051" and "D00052".</b></p> <p>Except for the addresses, all settings should be the same.</p>	<p>When placing the Keypad Input Display, do not rotate it. Doing so will cause the Pop-up keypad to display in the incorrect orientation.</p> <p>To cancel the placement, click on the  icon.</p> <p><b>Reference</b> To change the Part's size, refer to <b>2.4.3 Scaling Up/Down</b></p> <p>Double-clicking on any Part placed on the screen automatically calls up that Part's attribute settings.</p> <p><b>Reference</b> <b>2.4.14 Changing Attributes</b></p> <p>If the  key is pressed when the display area's border is scaled up or down, its interior characters are also scaled.</p>



■ Using a Keypad to Input Values

The following explanation shows how to use the Keypad Input Display's [Touch] and [Bit] selections.

◆ When using [Bit] method for data input

The procedures for entering setting values via a Keypad on the GP screen are shown below.

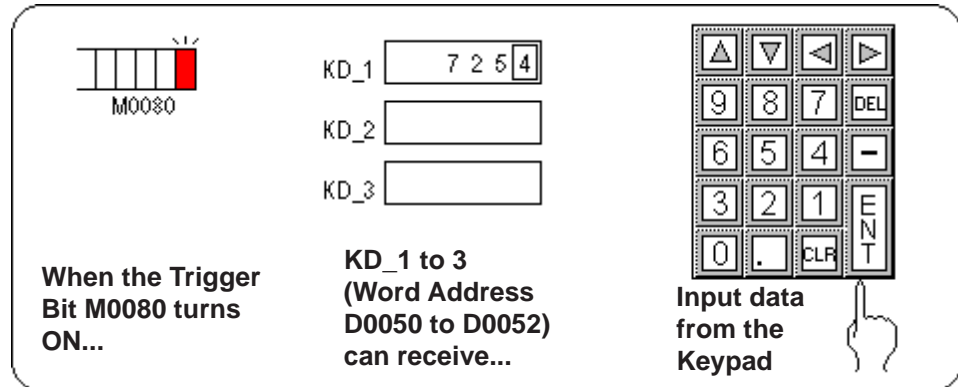

PROCEDURE	REMARKS
<p>(1) Here, three Direct Call-Ups have been set to share a common start bit.</p> <p style="text-align: center;">ID No.</p> <div style="display: flex; align-items: center; margin-bottom: 5px;"> <div style="border: 1px solid black; width: 40px; height: 15px; margin-right: 5px;"></div> <div style="margin-left: 5px;">— KD_1</div> </div> <div style="display: flex; align-items: center; margin-bottom: 5px;"> <div style="border: 1px solid black; width: 40px; height: 15px; margin-right: 5px;"></div> <div style="margin-left: 5px;">— KD_2</div> </div> <div style="display: flex; align-items: center;"> <div style="border: 1px solid black; width: 40px; height: 15px; margin-right: 5px;"></div> <div style="margin-left: 5px;">— KD_3</div> </div> <p>(2) Then, when the Device internal Trigger Bit M0080 turns ON,</p> <div style="text-align: center;"> <p>Device</p> </div> <p>(3) First, the Keypad Display KD_1's display reverses (highlights) and waits for input. The square box shown below represents the cursor's position.</p> <div style="display: flex; flex-direction: column; align-items: center;"> <div style="display: flex; align-items: center; margin-bottom: 5px;"> <div style="background-color: #cccccc; width: 40px; height: 15px; margin-right: 5px;"></div> <div style="border: 1px solid black; width: 10px; height: 10px; margin-left: 5px;"></div> </div> <div style="border: 1px solid black; width: 40px; height: 15px; margin-bottom: 5px;"></div> <div style="border: 1px solid black; width: 40px; height: 15px;"></div> </div>	<p>▼ <b>Reference</b> ▲ For how to create a Keypad, refer to <b>2.1.13 Keypads</b></p> <p>▼ <b>Reference</b> ▲ For how to create a Keypad Display, refer to <b>2.1.14 Keypad Display</b> ■ <b>Placing a Keypad Display</b></p>

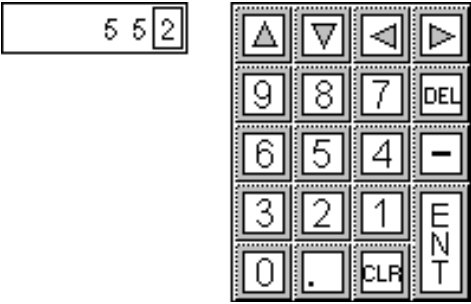
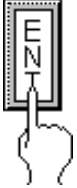
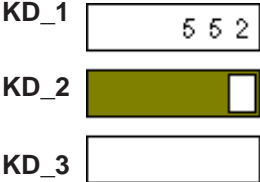
PROCEDURE	REMARKS
<p>(4) Press the Keypad's keys to input the desired value.</p>  <p>(5) Press the [ENT] key to register the value.</p>  <p>(6) The registered value will then be stored in Word Address D0050, which was designated in KD_1. Next, KD_2 will be highlighted and be ready to receive input.</p> 	<p>Set value display areas having a common Trigger Bit will enter a wait state in order, from the lowest ID number upwards. After the first value has been registered, the next value's display area will automatically be ready to receive input.</p> <div style="border: 1px solid black; padding: 5px; margin: 10px 0;"> <p>Keypad Input Display data entry is completed. (When designating a Bit Address)</p> </div> <p>After completing Keypad Display data entry, be sure to use the Device/PLC's control command to change the Input Completed bit from ON to OFF.</p>

◆ When using [Touch] method for data input (Popup Keypad is disabled)  
 ([Specify Entering Order] is selected)

The following explanation describes how to enter data via the Keypad.

When the [Touch] feature is selected and the Popup Keypad is disabled, touching the on-screen Input Display will cause that input area to change to reverse video. This indicates that cell/area of the keypad can accept input.

In the following example 6 Input displays are used, and all have [Specifying Input Order] selected. The settings for these 6 displays are as follows.

	Word Address	Input Order	Group No
KD_1	D00050	1	1
KD_2	D00051	2	
KD_3	D00052	3	
KD_4	D00053	1	2
KD_5	D00054	2	
KD_6	D00055	3	



**Note:** The [Specify Entering Order] feature is available only on GP2000 Series units.

KD\_1  KD\_4

KD\_1  KD\_2  KD\_5

Word address D0050 KD\_3  KD\_6

KD\_1  KD\_4

KD\_2  KD\_5

KD\_3  KD\_6

When the KD\_1 Keypad Input Display is touched. . .

The KD\_1 Keypad Input Display accepts input.

Enter the desired data from the keyboard (for specifying entering order), and confirm the entry by pressing the [ENT] key.

Next, in accordance with the data input order, the data entry field KD\_2 (Word Address D00051) will become active and ready to accept input.

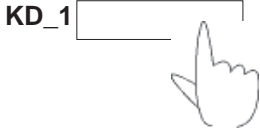
PROCEDURE	REMARKS																				
<p>(1) The following 6 input areas (KD_1 to KD_6) have been placed on the GP screen.</p> <p style="text-align: center;">ID Number</p> <div style="display: flex; justify-content: space-around; align-items: flex-start;"> <div style="text-align: center;"> <input style="width: 80px; height: 20px; border: 1px solid black;" type="text"/> KD_1         </div> <div style="text-align: center;"> <input style="width: 80px; height: 20px; border: 1px solid black;" type="text"/> KD_4         </div> </div> <div style="display: flex; justify-content: space-around; align-items: flex-start; margin-top: 10px;"> <div style="text-align: center;"> <input style="width: 80px; height: 20px; border: 1px solid black;" type="text"/> KD_2         </div> <div style="text-align: center;"> <input style="width: 80px; height: 20px; border: 1px solid black;" type="text"/> KD_5         </div> </div> <div style="display: flex; justify-content: space-around; align-items: flex-start; margin-top: 10px;"> <div style="text-align: center;"> <input style="width: 80px; height: 20px; border: 1px solid black;" type="text"/> KD_3         </div> <div style="text-align: center;"> <input style="width: 80px; height: 20px; border: 1px solid black;" type="text"/> KD_6         </div> </div> <p>(2) When the KD_1 Keypad Input Display is touched. . .</p> <div style="text-align: center; margin: 10px 0;">  </div> <p>(3) The touched KD_1 Keypad Input Display waits for input. The square box shown below represents the cursor's position.</p> <div style="display: flex; justify-content: space-around; align-items: flex-start;"> <div style="text-align: center;"> <div style="background-color: #cccccc; width: 80px; height: 20px; border: 1px solid black; position: relative;"> <div style="width: 20px; height: 20px; background-color: white; border: 1px solid black; position: absolute; top: 5px; left: 5px;"></div> </div> <input style="width: 80px; height: 20px; border: 1px solid black; margin-top: 5px;" type="text"/> </div> <div style="text-align: center;"> <input style="width: 80px; height: 20px; border: 1px solid black;" type="text"/> KD_4         </div> </div> <div style="display: flex; justify-content: space-around; align-items: flex-start; margin-top: 10px;"> <div style="text-align: center;"> <input style="width: 80px; height: 20px; border: 1px solid black;" type="text"/> KD_2         </div> <div style="text-align: center;"> <input style="width: 80px; height: 20px; border: 1px solid black;" type="text"/> KD_5         </div> </div> <div style="display: flex; justify-content: space-around; align-items: flex-start; margin-top: 10px;"> <div style="text-align: center;"> <input style="width: 80px; height: 20px; border: 1px solid black;" type="text"/> KD_3         </div> <div style="text-align: center;"> <input style="width: 80px; height: 20px; border: 1px solid black;" type="text"/> KD_6         </div> </div> <p>(4) Touch the appropriate key on the Keypad to enter the value.</p> <div style="display: flex; align-items: center; margin: 10px 0;"> <div style="margin-right: 20px;"> <div style="background-color: #cccccc; width: 80px; height: 20px; border: 1px solid black; position: relative;"> <div style="width: 20px; height: 20px; background-color: white; border: 1px solid black; position: absolute; top: 5px; left: 5px; text-align: center;">2</div> </div> </div> <div style="border: 1px solid black; padding: 5px;"> <div style="text-align: center; font-size: small;">Cancel</div> <table border="1" style="width: 100%; text-align: center; border-collapse: collapse;"> <tr> <td>▲</td><td>▼</td><td>◀</td><td>▶</td></tr> <tr> <td>7</td><td>8</td><td>9</td><td>DEL</td></tr> <tr> <td>4</td><td>5</td><td>6</td><td>-</td></tr> <tr> <td>1</td><td>2</td><td>3</td><td>ENT</td></tr> <tr> <td>0</td><td>CLR</td><td></td><td></td></tr> </table> </div> </div>	▲	▼	◀	▶	7	8	9	DEL	4	5	6	-	1	2	3	ENT	0	CLR			<p>Be sure to select only Input Displays that use the [Specify Entering Order] feature.</p> <p><b>Reference</b> For how to create a Keypad Display, refer to <b>2.1.14 Keypad Display ■ Placing a Keypad Display</b></p> <p>If while entering data you change the Input Display's Interlock touch status (Enabled to disabled, or vice-versa), the Keypad will become active. Continue to enter data normally and touch the Enter key to register the data, or touch [Cancel] / [ESC] to ignore the data. However, Keypad Input Displays have no built-in input cancel feature to delete entered data.</p>
▲	▼	◀	▶																		
7	8	9	DEL																		
4	5	6	-																		
1	2	3	ENT																		
0	CLR																				

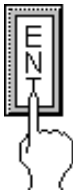
PROCEDURE	REMARKS
<p>(5) <b>Press the ENT key to register the value.</b> The Keypad will then close.</p>  <p>(6) <b>The data entered in display KD_1 is saved to Word Address D00050. The cursor then moves to KD_2, the display changes to reverse video and waits for input.</b></p> <p>KD_1 <input type="text" value="5 5 2"/></p> <p>KD_2 <input type="text" value=""/></p> <p>KD_3 <input type="text" value=""/></p> <p>Since displays KD_1 to KD_3 are designated as Group 1, after KD_3 input is finished, the cursor will return to KD_1 and wait for input. If KD_4 is touched, the cursor will jump to that display and entry is possible. Once entry is finished, the cursor will jump to the next display in Group 2.</p>	<p>Among multiple displays belonging to the same Group, the display with the lowest ID No will be the first to accept input.</p> <p>When this is selected/enabled, you can designate the location (coordinates) where the Popup Keypad will appear. Available only with GP2000 Series units.</p> <p>In the following cases, the cursor will not automatically jump to the next display.</p> <ul style="list-style-type: none"> <li>• Displays with Interlock enabled.</li> <li>• Displays where [Specify Entering Order] is disabled, or when Version 6.3 or earlier GP-PRO/PBII is being used.</li> </ul>

◆ Keypad Input Display's [Touch] feature is Selected/Enabled ([Specify Entering Order] is disabled)

The procedure for positioning the Keypad Input Display featuring the Pop-up Keypad is shown below.



- The Pop-up Keypad feature is available only with the GP-377, GP77R, and GP2000 series.
- The [Specify Entering Order] feature is available only on GP2000 Series units.

**When the KD\_1 Keypad Input Display is touched. . .**

**The Pop-up Keypad appears, and the touched display waits for input.**

**Input data using the Pop-up Keypad.**

PROCEDURE	REMARKS
<p>(1) The Keypad Input Display "KD_1" is displayed on the GP screen.</p> <div style="text-align: center;"> <p>ID Number KD_1</p> </div> <p>(2) When the KD_1 Keypad Input Display is touched. . .</p> <div style="text-align: center;"> </div> <p>(3) The Pop-up Keypad appears, and the touched display waits for input. The square box shown below represents the cursor's position.</p> <div style="text-align: center;"> </div>	<p><b>Reference</b> For how to create a Keypad Display, refer to <b>2.1.14 Keypad Display ■ Placing a Keypad Display</b></p> <p>When [Specify Arrangement Position] is not selected/disabled, the Pop-up Keypad will be automatically placed on the screen.</p> <p>When [Specify Arrangement Position] is selected/enabled, the Pop-up Keypad will appear in the designated position.</p>

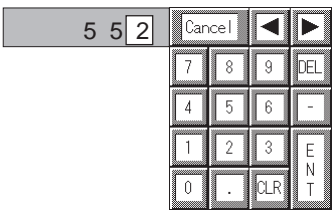
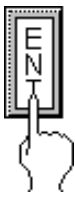
PROCEDURE	REMARKS	
<p>(4) Touch the appropriate key on the Pop-up Keypad to enter the value.</p> 	<p>In the following two cases, the pop-up keypad will disappear with no confirmation of the input during data input:</p> <ul style="list-style-type: none"> <li>• When the active Keypad Input Display is touched</li> <li>• When another Keypad Input Display is touched during data input (only when the [Use Pop-up keypad] feature is enabled for Keypad Input Display)</li> </ul> <p>The Keypad Input Display that has been touched becomes active and is displayed in reverse video, calling up the pop-up keypad for display on the screen.</p>	
<p>(5) Press the ENT key to register the value. The Pop-up Keypad will then close.</p> 		<p>When [Cancel] / [ESC] is touched, the Pop-up Keypad closes without registering the input value.</p>
<p>(6) The registered value will then be stored in Word Address D0050, which was designated in KD_1.</p> <p>KD_1 <input type="text" value="5 5 2"/></p>		<div style="border: 1px solid black; padding: 5px;"> <p>Keypad Input Display data entry is completed. (When designating a Bit Address)</p> </div> <p>After completing Keypad Display data entry, be sure to use the Device/PLC's control command to change the Input Completed bit from ON to OFF.</p>

◆ Notes for using Pop-up Keypad

- Do not specify [High Speed] from [Designated Window] of a U-tag when using Pop-up Keypad with the Keypad Input Display.
- Do not rotate the Keypad Input Display when you position it. Otherwise, the Pop-up Keypad will not appear in the proper orientation.

### ◆ Restrictions for using Pop-up Keypad



- If the Keypad Input Display selected does not use the Pop-up Keypad feature or if the trigger bit in the K-tag is set to ON, the Pop-up Keypad will not appear.
- If the Pop-up Keypad's [Specify Arrangement Position] is not selected/disabled, the Pop-up Keypad will appear to the right of the Keypad Input Display. If there is insufficient space to the right of the Keypad Input Display to display the Pop-up Keypad, the Keypad automatically appears in a position either above, below, or to the left of the Keypad Input Display.
- If the Pop-up Keypad's [Specify Arrangement Position] is not selected/disabled, and there is insufficient space in each of these positions, the Keypad will appear in the lower right corner of the screen. In this case, the Pop-up Keypad and the Keypad Input Display may overlap so that you cannot see the input value.
- The Pop-up Keypad is displayed as a local window. When two local windows are already displayed on the screen, the Pop-up Keypad does not appear even if the Keypad Input Display is touched. In this case, the Keypad Input Display will not wait for input.  
Also, if during numeric display data input two or more Local Windows are opened, input will stop and the currently input value will be deleted.
- When the pop-up keypad and other windows overlap, touch the desired window to bring it to the front.
- The tag size of the Keypad Input Display that uses the Pop-up Keypad is greater than those without the Pop-up Keypad by 60 bytes. (When the Pop-up Keypad is used with the initial setting, the Keypad Input Display capacity is 276 bytes, and 216 bytes when the Pop-up Keypad is not used.)
- When the Touch Available Condition of the Interlock function is disabled, the Pop-up Keypad is not displayed.
- When the Touch Available Condition is switched to OFF while input is being made on the Keypad Input Display, the Pop-up Keypad continues to function. Continue the input, and confirm the entry with the Enter key as usual, or press the Cancel key to cancel the input. However, note that touching the Keypad Input Display will not cancel the input.
- When the [Enter Specifying Order] feature is selected/enabled on an Input Display that uses the Pop-up Keypad feature, the Pop-up Keypad will be automatically selected, depending on the [Display/Write Data Format] feature's setting. If you wish to modify or change this Pop-up Keypad,

▼ **Reference** ▼ ■ *Editing the Pop-up Keypad (next page)*

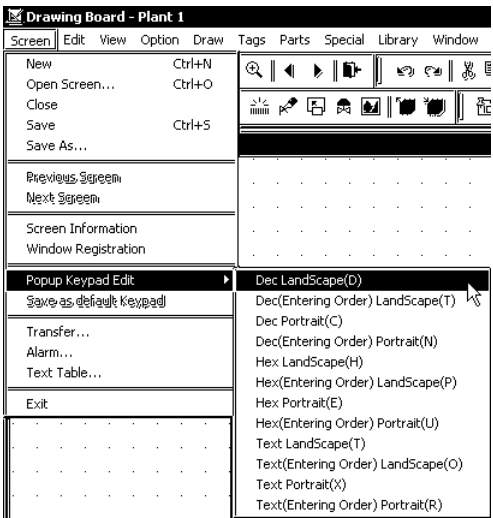
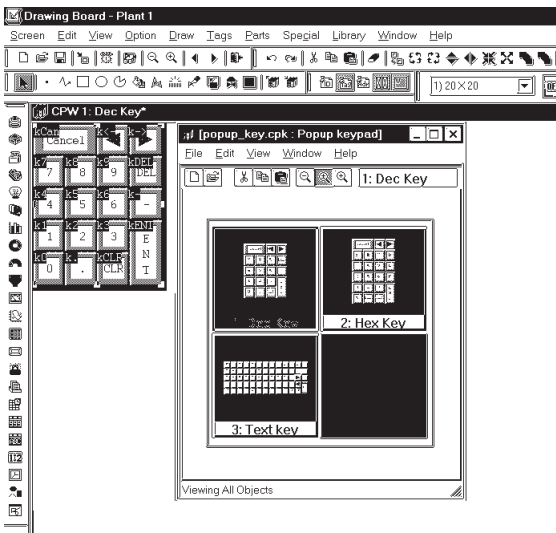

### ■ Editing the Pop-up Keypad

When the Start area's [Touch] and the Popup area's [Exists] features are selected, the [General Settings] tab of the [Keypad Input Display], a keypad is displayed that is preset with the [Display Data Format] settings in [Display Format]. However, the keypad settings can be edited to your preference.

PROCEDURE	REMARKS
<p>(1) Select the [Screen] menu - [Popup Keypad Edit] command.</p> <p>(2) Select the type of Pop-up Keypad to use: [Dec Landscape], [Dec (Entering Order) Landscape], [Dec Portrait], [Dec (Entering Order) Portrait], [Hex Landscape], [Hex (Entering Order) Landscape], [Hex Portrait], [Hex (Entering Order) Portrait], [Text Landscape], [Text (Entering Order) Landscape], [Text Portrait], [Text (Entering Order) Portrait]. The editing screen for the Pop-up Keypad appears.</p>  <p style="text-align: center;">↓</p> 	<p>When "GP***** Vertical Type" is selected as the GP Type, a pop-up keypad for the vertical type is displayed. When editing the pop-up keypad, select a keypad designed for the vertical type.</p> <p>The Popup Keypad displayed via the [Specify Entering Order] feature should only be used when the Keypad Input Settings screen's [Specify Entering Order] feature has been enabled.</p> <p>The library browser automatically opens. You can select a keypad from the library.</p> <p>The CPK file displayed here cannot be edited.</p> <p>You can also create a keypad as desired.</p> <p><b>Reference</b> 3.3 <i>Creating a Keypad: the Keypad Screen</i> ■ <i>Creating a Keypad (3)</i></p> <p>Do not use the   keys. They are disabled on a pop-up keypad that is not used for the [Specify Entering Order] feature.</p> <p>For ST series units, the Pop-up Keypad library's 20-dot unit Keypad will not operate even when selected / set.</p> <p>For ST Unit usage restrictions,</p> <p><b>Reference</b> 2.12.2 <i>Restrictions</i></p>

PROCEDURE	REMARKS
<p><b>(3)Edit the Pop-up keypad.</b>  <b>When changing the size and place of the Pop-up Keypad, a clear area must be changed. Specify a clear area to surround the entire pop-up keypad.</b></p> <p><b>(4)Select [Save] from the [Screen] menu or click the  icon to save the pop-up keypad you have edited.</b>  This will be used as the Pop-up keypad within the project.</p>	<p>When the range of the clear area is specified, the X-axis can be specified in units of eight dots. Fractions will be automatically translated into eight-dot units. The Y-axis can be specified arbitrarily.</p> <p>Clear Area is reset using the [Tag] -&gt; [Clear Area] selection. Selecting Clear Area allows the clearing of sections that will not be displayed when switching between different size keyboards.</p> <p>When saving the edited Pop-up keypad, select [Save as default Keypad] from the [Screen] menu. The pop-up keypad will be used as the default keypad for all future projects.</p>

■ Using the Time-Base function

- The Time-Base function is featured in PLCs manufactured by Siemens Corporation (S5 and S7 Series), and cannot be used with other devices.

The following table lists the supported protocols:

Siemens AG	SIEMENS S5 90-115 Series
	SIEMENS S5 135-155 Series
	SIEMENS S5 3964 (R) Protocol
	SIEMENS S7-200 PPI
	SIEMENS S7-200 via MPI
	SIEMENS S7-300/400 (ETHER)
	SIEMENS S7-300/400 via MPI
	SIMATIC S7 via 3964/RK512
PROFIBUS	PROFIBUS-DP

- This function is supported only by GP2000 Series (except for the GP2000H Series) and ST Series.
- A total of 16 bits of data are used, with the upper four bits showing the Time-Base mode, and the remaining 12 bits showing the display data. These 12 bits are processed using 3 digits of BCD data.
- Time-Base data can have decimal points, spaces or zeroes (“0”), with the character “s” always included on the right. (See table below)

Upper 4 bits	Remaining (Lower) 12 bits			Display Range
Time-Base Mode	BCD (3 digits)			
0 (0.01s)	0 to 9	0 to 9	0 to 9	0.00s to 9.99s
1 (0.1s)				0.0s to 99.9s
2 (1 s)				0 s to 999 s
3 (10s)				0s to 9990s



**Note:** If the digit entered for the Time-Base mode is not 0, 1, 2, or 3, it is treated as “3”.

Clicking the “Time-Base” selection in the Keypad Input Display Part’s Display Format tab, enables the Time-Base function.

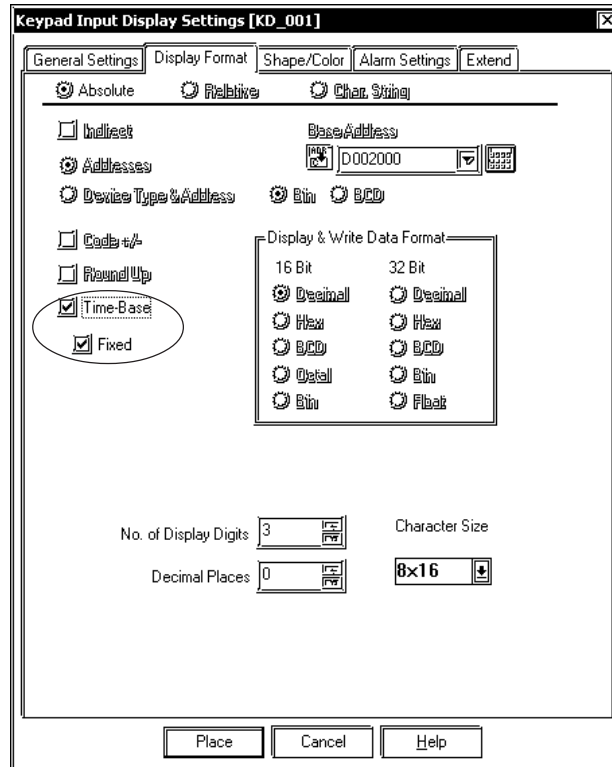

When the Keypad Input Display Part’s Time-Base feature is enabled, the “Fixed” function becomes available.

◆ **When “Fixed” is selected**

This function retains/keeps the number of decimal points set in the Time-Base function selection during input. (Upper 4 bit values designate the Time-Base mode.)

Input Value	Value shown in Keypad Input Display			
	0 (0.01s)	1 (0.1s)	2 (1s)	3 (10s)
0	0.00s	_0.0s	__0_s	___0s
2	2.00s	_2.0s	__2_s	___20s
1.2	1.20s	_1.2s	Input not accepted <sup>(A)</sup>	Input not accepted <sup>(A)</sup>
12	2.00s	12.0s	_12_s	_120s
1.23	1.23s	_1.3s <sup>(C)</sup>	Input not accepted <sup>(A)</sup>	Input not accepted <sup>(A)</sup>
12.3	2.30s <sup>(B)</sup>	12.3s	Input not accepted <sup>(A)</sup>	Input not accepted <sup>(A)</sup>
123	3.00s <sup>(D)</sup>	23.0s <sup>(B)</sup>	123_s	1230s

- (A) Since Time-Base mode selections 2 and 3 have no decimal places, decimal point input is not accepted. If decimal point values have been entered, please press the Pop-up Keypad’s [Cancel] button, or enter a value with no decimal points.
- (B) To ensure the cursor does not move below the decimal point, the “1” digit of the data entered is deleted.
- (C) Since only 1 digit is allowed to the right of the decimal point, the first character to the right of the decimal point, “2”, is deleted.
- (D) To ensure the cursor does not move below the decimal point, the “1” and “2” digits entered are deleted.

◆ When “Fixed” is not selected

This setting is used to improve the accuracy of the values displayed, without selecting the Time-Base mode.

Input Value	Value shown in Keypad Input Display			
	0 (0.01s)	1 (0.1s)	2 (1s)	3 (10s)
0 <sup>(A)</sup>	0.00s	←	←	←
0.0	0.00s	←	Cannot display	Cannot display
2 <sup>(B)</sup>	2.00s	←	←	Cannot display
1.2 <sup>(C)</sup>	1.20s	←	Cannot display	Cannot display
12 <sup>(D)</sup>	Cannot display	12.0s	←	Cannot display
1.23	1.23s	Cannot display	Cannot display	Cannot display
12.3	Cannot display	12.3s	Cannot display	Cannot display
123	Cannot display	Cannot display	123_s	Cannot display
1230	Cannot display	Cannot display	Cannot display	1230s
1234 <sup>(E)</sup>	Cannot display	Cannot display	Cannot display	Cannot display

← ..... Indicates that display is possible, but will be displayed using the highest-precision possible.

Cannot display ..... The entered value cannot be displayed in the selected Time-Base mode.

- (A) Can be displayed using any type of Time-Base mode, however it will be displayed using the highest-precision Time Base mode [0].
- (B) Values can be displayed using Time-Base modes [0], [1], or [2], however it will be displayed using the highest-precision Time Base mode [0].
- (C) Values can be displayed using Time-Base modes [0], [1], or [2], however it will be displayed using the highest-precision Time Base mode [0].
- (D) Values can be displayed using Time-Base modes [1], or [2], however it will be displayed using the higher-precision Time Base mode [1].
- (E) Value cannot be displayed using any of the Time-Base modes and cannot be entered. Either press the Pop-up Keypad’s [Cancel] button, or enter a value that can be displayed.

**2.1.15 Alarm Display**

When the device Monitor Bit has been turned ON, messages registered in the Alarm Summary by the Alarm Editor, can be displayed in a list.

**Reference** Chapter 5 CREATING AND EDITING ALARMS

Message display order is decided according to which Monitor Bit is in the lowest position in the Alarm Summary display area. It is recommended that Monitor Bit assignment begins from the message with the highest priority. Be sure to input only one message per line. The characters of a message that exceed one line will be truncated.

The number of the characters that can be displayed in one line will vary depending on the character size and GP type. When the size is 1 x 1, the maximum number of characters that can be displayed per line for each GP model is:

Maximum Number of Characters	GP Type
40	GP-H70, GP-270, GP-370, GP-377, GP-377R, GP-2301H, GP-2300, GP-2301
80	GP-470, GP-570, GP-571, GP-870, GP-477R, GP-577R, GP-2401H, GP-2400, GP-2401, GP-2500, GP-2501
100	GP-675, GP-2600, GP-2601

**Alarm Summary [Description] Attributes**

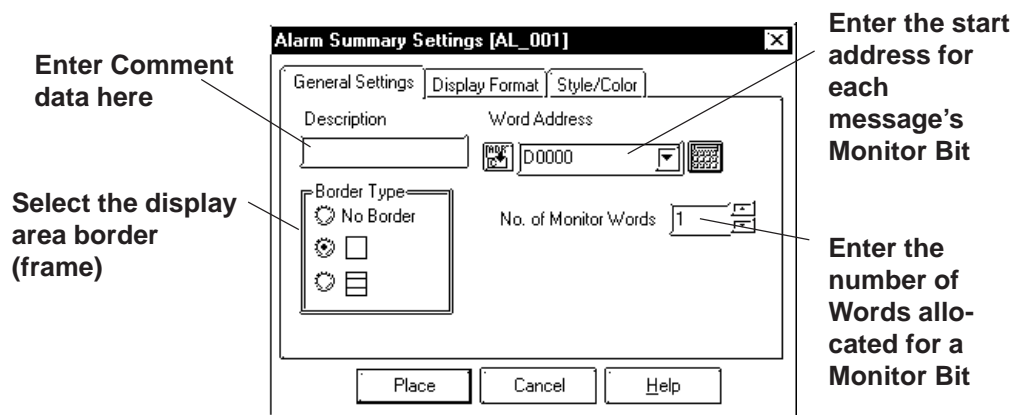

**Border Type**

The display area frame types are No Border, Outside, and Outside + Inside.

◆ **Word Address**

The Monitor Bit's first address for the messages specified by the Alarm Editor is input. Input this address in word units.

E.g.) How to designate a Word Address (MELSEC-A Series - Mitsubishi):  
When designating the Word Address for the input/output or internal relay, the Word Address is designated from the Least Significant Bit.

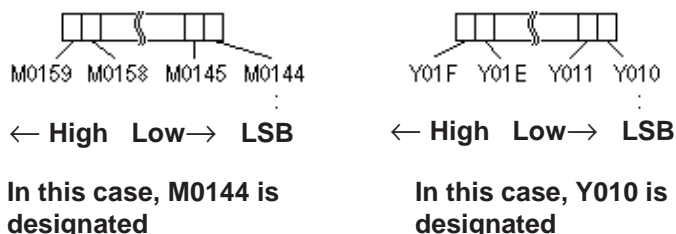

*Important*

**When a variable (GLC symbol) is used as an address, an integer array must be designated. For an integer array, the space required for consecutive addresses needs to be allocated. If the space (addresses) needed for the continuous addresses' array is not reserved/set up, the Part/feature will not operate correctly.**

**Also, be aware that during Online Edit, the addition and deletion of variables may not operate correctly.**

◆ **No. of Monitor Words**

Here, the number of words a Monitor Bit is assigned and entered. Up to 100 words can be monitored.

■ **Alarm Summary [Display Format] Attributes**

Designates from which existing error message will the display begin

Designates the No. of Lines of a message that can be displayed on one screen

Designates the maximum No. of Characters per line

### ■ Display Start Line

Among the messages whose Monitor Bit is turned ON, the Start Line designates from which message the display starts.



#### **Note:** When the Alarm Summary display cannot fit in a single screen:

Only one Alarm Summary display can be placed on a screen. When the number of messages to be displayed does not fit on one screen, create Alarm Summary displays on multiple screens, so that the screens will switch to display all the messages. To display all error messages continuously, specify each screen's Start Line as follows:

The first screen: ..... The starting line

The second screen: ..... The number of display lines on the first screen + 1

.

.

.

The nth screen: ..... The number of display lines on any screen  $\times (n-1) + 1$

### ◆ No. of Display Lines

Designates the maximum number of alarm message lines that can be displayed on one screen. Up to 50 lines can be displayed.

### ◆ No. of Display Char.

Designates the maximum number of characters that can be displayed on a line. The screen's limit is 100 characters per line. However, the maximum number of characters for each GP unit will vary depending the model.

### ■ Alarm Summary [Style/Color] Attributes

The display area color when a message is cleared (Clear Color) is selected.

**▼ Reference ▲** 2.1 Parts ■ *Selecting Colors*



■ Placing an Alarm Summary Display Area

The Alarm Summary Display Area's setting procedure is shown below.

	Bit Address	Type	Message
1	X00010	Summary	ErrorCode030 Unit 0D5
2	X00050	Summary	ErrorCode040 Unit 0D5
3	X00051	Summary	ErrorCode041 Unit 0D6

ErrorCode030 Unit 0D5
ErrorCode040 Unit 0D5
ErrorCode041 Unit 0D6
⋮

**100 Alarm Messages, have been assigned to bits M0800 ~ M0899 in the Alarm Editor**

**Appear on the screen in a Summary Display, at 10 lines by 30 characters per display.**

PROCEDURE	REMARKS
-----------	---------

(1) Select the [Parts] menu - [Alarm Display] command, or click on the icon.

(2) In the [General Settings] tab, input the Word Address, No. of Monitor Words, and select one of the Show Border options.  
Here, since the Word Address range is from M0800 to M0899, enter "7" for the number of Monitor Words.

▼ **Reference** 2.1.15 Alarm Display ■ Alarm Summary [Description] Attributes ◆ Word Address

Enter M0800

Enter 7



Select Border type

(3) In the [Display Format] tab, input the Display Start Line, No. of Display Lines, and No. of Characters. In the [Style/Color] tab, select the Clear(ing of Data) Color, if desired.

Enter 1

Enter 10

Enter 30

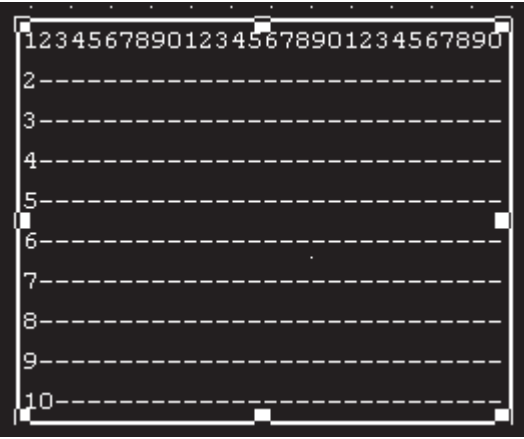
PROCEDURE	REMARKS
<p>(4)After all of the Part’s attributes have been entered and selected, click on the <input type="button" value="Place"/> button. The Alarm Summary display area’s border will appear in the Base screen, next to your cursor.</p> <p>(5)Click on the point where the Alarm Summary display area’s top left corner is to be placed. If desired, use the Alarm Summary display handles to alter its size. When the Alarm Summary display is scaled up or down, the displayed character size will also change, according to the border’s size.</p>	<p>To cancel placement, click on the  icon.</p> <p><b>Reference</b> To change the Part size, refer to refer to <b>2.4.3 Scaling Up/Down</b></p> <p>Double-clicking on any Part placed on the screen automatically calls up that Part’s Attribute Settings dialog box.</p> <p><b>Reference</b> <b>2.4.14 Changing Attributes</b></p> <p> <i>Important</i></p> <p><b>Be sure to use the Alarm Summary’s display area only for displaying Alarm Messages, i.e. never place, overlap, or overlay another Part or object in this area.</b></p>
	

### 2.1.16 File Name Display

Data registered in the Filing Data settings is displayed.



**Set up the Filing Data Settings before placing the File Name Display. For information on registering the Filing Data:**

**Reference** *Tag Reference Manual, 4.2 Filing Data (Recipe) Function*

#### ■ File Name Display [General Settings] Attributes

Enter a description if desired

Enter the ID number for the File Name Display and its function switch

Enter the File No. of filing data to be displayed.

Specify whether or not to use the LS area

Enter the start word address of the LS area

Set up the PLC Transfer Completed Bit Address.

#### ◆ Description

Enter a description using a maximum of 20 single-byte characters.

#### ◆ ID No.

The File Name Display is linked to its function switch (File Name Key). Specify the number to identify this link is here. This number is available up to 255.

#### ◆ File No.

Enter the file number registered in the Filing Data list (1 to 2047). The names under this number are displayed when the file is opened.

**Reference** *Tag Reference Manual, 4.2 Filing Data (Recipe) Function*

#### ◆ By Way of LS

When Filing Data is transferred between backup SRAM and the PLC, it can be modified on the GP screen by routing it via the LS area (the data is stored temporarily in the LS area). If data transfer via the LS area is used, specify the LS area's start-word address where Filing Data will be stored from. The address where the data can be stored is from LS0020 to LS2031, and LS2096 to LS4095 (LS2096 to LS8191 for GP2000 series).

#### ◆ PLC Transfer

This Bit is turned ON when filing data transfer to the PLC is completed. Since this Bit does not turned OFF automatically, to use the PLC Transfer Completed Bit again, turn it OFF beforehand.



**Note:** When the PLC Transfer Completed Bit Address has been entered, in the case where filing data cannot be transferred to the PLC, the GP's special relay LS2032 Bit 10 will be turned ON.

## ■ File Name Display [Display] Attributes

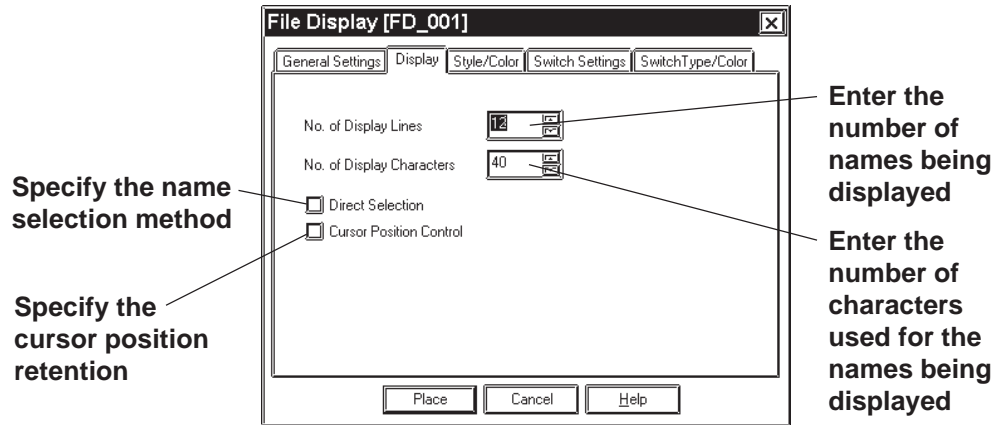

### ◆ No. of Display

Specify the number of Filing Data rows displayed on the GP. A maximum of 50 rows may be specified.

### ◆ No. of Display Characters

Specify the number of Filing Data characters used on each row. A maximum of 100 characters may be specified.

### ◆ Direct Selection

Select a File Name Display being placed on the GP by directly touching its border. If [Direct Selection] is not used, select the file name using the data scroll switches [Roll Up/Roll Down].

## ▼ Reference ■ File Name Display [Switch Settings] Attributes

### ◆ Cursor Position Control

Even when the screens are changed on the GP, the current screen's cursor position can be retained. When turning the GP's main power switch ON or resetting the GP, however, the cursor will appear in the first line.



**Note:** The cursor position will be stored for each ID No. To retain the cursor position, be sure that the File Name Display ID Nos. will not be overlapped through all the screens.

## ■ File Name Display [Style/Color] Attributes

Specify a color [display color (Fg)] for characters in the Filing Data display area, and a color [display color (Bg)] of the Filing Data display area.

## ▼ Reference 2.1 Parts ■ Selecting Colors

## ■ File Name Display [Switch Settings] Attributes

Set the function switches that are placed automatically.

### ▼ Reference ▲ 2.1.3 Function Switches

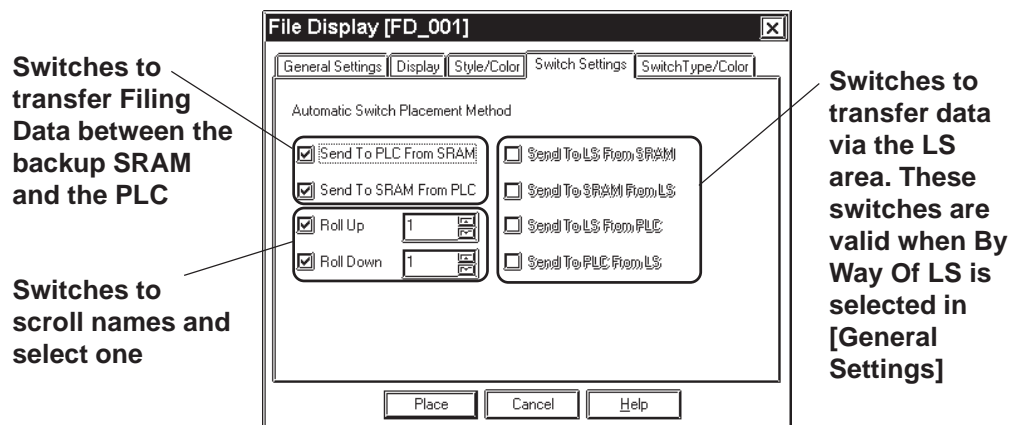

### ◆ Automatic Switch Placement Method

Automatically places the function switches for the selected names.

### ◆ Send To PLC From SRAM

Places the switch used to transfer Filing Data from the backup SRAM to the PLC.

### ◆ Send To SRAM From PLC

Places the switch used to transfer Filing Data from the PLC to the backup SRAM.

### ◆ Roll Up

Places the Roll Up key used to scroll names and select one. Touching the Roll Up key once will roll up names by the number specified here.

### ◆ Roll Down

Places the Roll Down key used to scroll names and select one. Touching the Roll Down key once will roll down names by the number specified here.

### ◆ Send To LS From SRAM

Places the switch used to transfer Filing Data from the backup SRAM to the LS area.

### ◆ Send To SRAM From LS

Places the switch used to transfer Filing Data from the LS area to the backup SRAM.

### ◆ Send To LS From PLC

Places the switch used to transfer Filing Data from the PLC to the LS area.

### ◆ Send To PLC From LS

Places the switch used to transfer Filing Data from the LS area to the PLC.

■ File Name Display [Switch Type/Color] Attributes

Specify colors (border colors) for the function switches which are placed automatically.

▼ **Reference** ▲ 2.1.3 Function Switches



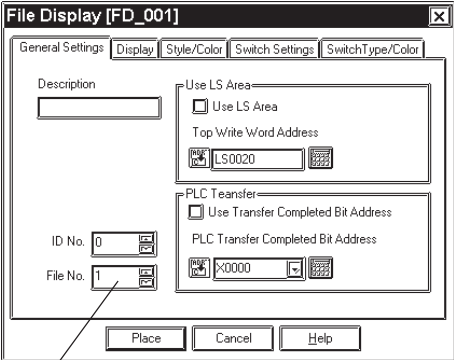

■ Place File Name Display

Shows how to call up the File Name Display.

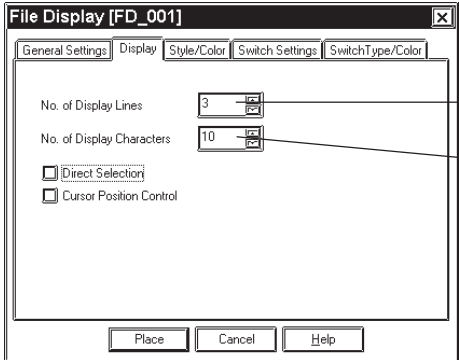
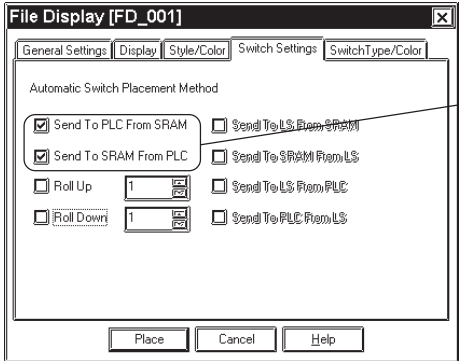
~20°C	<p><b>Registered File No. 1's filing data is displayed on the File Name Display with 3 display lines and 10 display characters. By pressing a function key (File Name Key), filing data can be transferred from the SRAM to the PLC, or from the PLC to the SRAM.</b></p> <p>▼ <b>Reference</b> ▲ For filing data list and registering filing data, refer to <i>Tag Reference Manual, 4.2 Filing Data (Recipe) Function.</i></p>
21 ~35°C	
36°C ~	
SRAM →PLC	PLC → SRAM

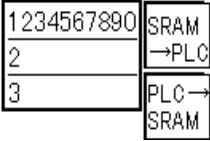
PROCEDURE	REMARKS
<p>(1) Select the [Parts] menu - [File Name Display] command, or click on the  icon.</p> <p>(2) In the [General Settings] tab, enter the File No. of filing data to be transferred and the File Name Display's ID No. Here, since File No. 1's data is transferred, enter "1" for the file number. The File Name Display's ID No. is "0".</p>  <p>Enter 1</p>	<p>▼ <b>Reference</b> ▲ ■ File Name Display [General Settings] Attributes</p> <p>To transfer Filing Data via the LS area, mark the check box for [Use LS Area] in the [Use LS Area].</p>

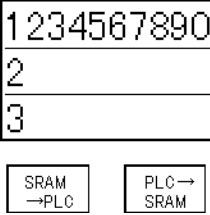
PROCEDURE	REMARKS
<p><b>(3) In the [Display] tab, specify the No. of Display Lines, Display Characters, Direct Selection, and Cursor Position Control.</b> If necessary, specify the display color in the [Style/Color] tab.</p>  <p style="margin-left: 400px;">Enter 3</p> <p style="margin-left: 400px;">Enter 10</p>	
<p><b>(4) In the [Switch Settings] tab, select the function switches which are being placed automatically, and specify the number of lines being rolled up or down.</b></p>  <p style="margin-left: 400px;">Select these two switches</p>	
<p><b>(5) Specify the border colors for the function switches in the [Switch Type/Color] tab.</b></p>	
<p><b>(6) After setting all the attributes, click on <span style="border: 1px solid black; padding: 2px;">Place</span>.</b> The frame of the File Name Display size will be displayed in the drawing area.</p>	

PROCEDURE	REMARKS
<p>(7) Click the mouse button where you want to place each attribute.</p>  <p>(8) Select the placed File Name Display. Then, select the [Edit] menu - [Ungroup] command, or click on the  icon to ungroup the File Name Display and alter each item's position and size.</p> 	<p>To cancel the placement, click on the  icon.</p> <p>The File Name Displays are grouped. To change any attribute, first ungroup the File Name Displays, and then change the attribute.</p> <p><b>Reference</b> 2.4.12 <i>Group/Ungroup</i></p> <p><b>Reference</b> 2.4.14 <i>Changing Attributes</i></p> <p>If the By Way Of LS area is selected, the address for the LS area can be changed after ungrouping the File Name Displays.</p>



### 2.1.17 Data Logging Display

Data created in the data logging settings can be displayed and edited on the GP unit.



- **After the data logging settings, place the Data Logging Display.**

**Reference** For registering logged data, refer to *Tag Reference Manual; 4.3 Logging Function*

- **The Data Logging Display does not operate in a window.**



- Only one Data Logging Display can be placed on each screen.
- The Logging Display cannot be set up simultaneously with the K-tag, N699 tag, Keypad Input Display or CSV Display.
- Data that could not be logged due to a read error is identified with “\*\*\*” in a cell.
- Data that is not logged is not displayed.

#### ■ Data Logging Display [General Settings] Attributes

Enter a comment, if necessary

Specify whether the data edit function is enabled or disabled

Specify whether the interlock function is enabled or disabled

Using a word address, specify the block number of data being displayed

Using a bit address, specify the interlock address

#### ◆ Block Number Address

On a block basis, specify the data being displayed. The logged data for the block number stored at the word address specified here will be displayed.

The block numbers that can be entered are between 0 and 2047, but the maximum of the effective range is [Number of Blocks] specified in [Trigger Settings] in the data logging settings. If [Number of Blocks] specified in [Trigger Settings] is 4, the block numbers are 0 to 3 (BIN values only).



- If any block number that does not exist is specified, no data will be displayed.
- When the loop function has been designated via [Trigger Settings] of the data logging settings, the Block Number Address will become ineffective.

### ◆ Data Edit

The logged data can be modified by directly touching the frame of each item in the Data Logging Display placed on the GP. If Data Edit is enabled, touching the cell of data that can be modified in the table will cause the buzzer to sound and allow you to enter data. If Data Edit is disabled, this touching will be invalid and the buzzer will not sound.



- Note:**
- The data that can be modified is only [Date] and [Value] that have been logged.
  - If a block or logged data is selected by changing the block number during on-screen modification of data, the data edit mode is canceled.
  - If the cell is moved beyond the display area, using the scroll keys during the data edit mode, the data edit mode is canceled.

### ◆ Interlock

The interlock can only be activated when the data edit capability is enabled. If the interlock is enabled, data can be modified only when the bit address for the interlock is ON. If the interlock is disabled, data can always be modified by touching it.



- Note:** If the bit address for the interlock is turned OFF during on-screen modification of data, the data edit mode is canceled.

## ■ Data Logging Display [Data Type] Attributes

Select a Border Type of the display area



Specify whether the scrolling of the totaling section is enabled or disabled

Enter the number of rows for the items displayed (0 to 40)

Enter the number of columns for the items displayed (0 to 25)

Enter a display interval (the number of dots) (0 to 10)

### ◆ Border Type

Select a border type of the display area from among three types, No Border, outer border  (1-dot lines), and outer border plus inner border  (the outer border and item use 2-dot lines, while the inner border uses 1-dot lines).

### ◆ Row

Specify the number of rows used to display logged data on the GP. A maximum of 40 rows may be specified.

◆ **Column**

Specify the number of columns used to display logged data on the GP. A maximum of 25 columns may be specified.

◆ **Spacing**

Specify spacing at which to display logged data on the GP. A maximum of 10 dots may be specified. This entry is only valid when the display area border type is specified as No. Border. Draw the border line using the drawing tool.



**Note:** The gap equivalent to the specified display spacing is provided between the cell and the border line. The entire cell is filled with the clear color specified in the Data Logging Display [Color] Attributes. However, the gap is not displayed in the clear color, but its background is displayed. If No Border is selected to draw an arbitrary border, ensure that the border is drawn using the same width as the specified display interval without overlapping the cell.

<Display Spacing>

◆ **Scroll data area**

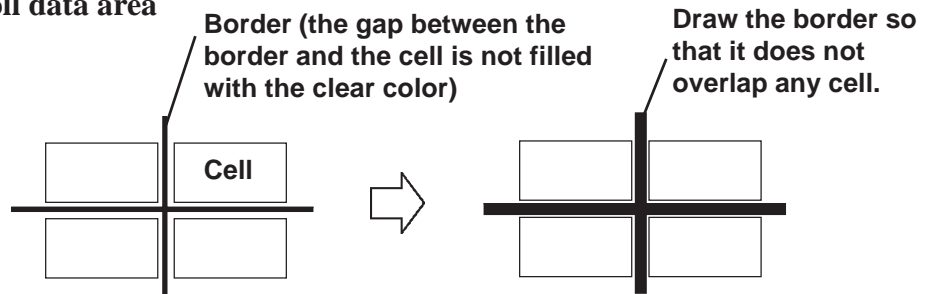

If the scroll data area is enabled, the totaling section is scrolled together with the data section. If the totaling section scroll is disabled, the totaling section always appears on the screen.

■ **Data Logging Display [Color] Attributes**

Select a color (clear color) displayed when the border of each item is cleared. **Reference** 2.1 Parts ■ *Selecting Colors*

### ■ Data Logging Display [Switch Settings] Attributes

The number of rows and that of columns specified in [Data type] are displayed on the Data Logging Display. If any data exceeding these numbers exists in the GP, use the function switches to scroll the data.

#### ▼ Reference ▲ 2.1.3 Function Switches

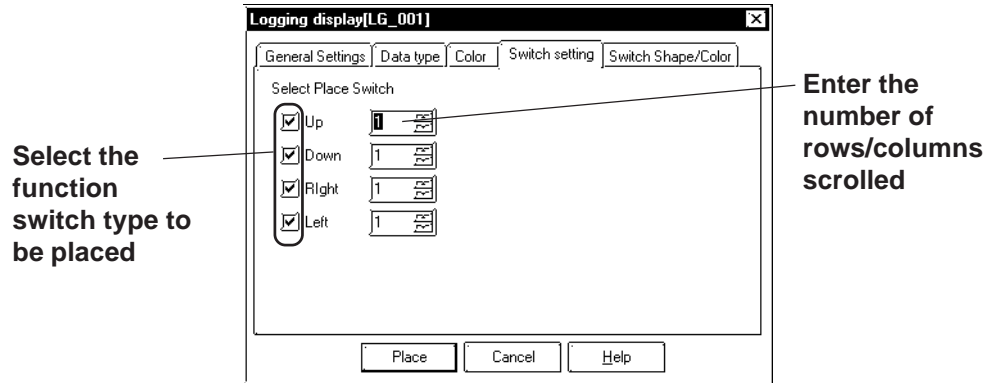

### ■ Data Logging Display [Switch Type/Color] Attributes

Specify a color (border color) of each function switch.

#### ▼ Reference ▲ 2.1 Parts ■ Selecting Colors

**■ Placing the Data Logging Display**

The procedure for setting the Data Logging Display is described below:

The logged data for the block number stored at the block number designated address is displayed.

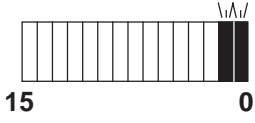

If 3 is stored at D0100.

➔

	Date	Time	Data1	
1st	98/10/16	09:14:00	144	LP
2nd	98/10/16	09:14:00	145	EM
3rd	98/10/16	09:14:01	146	R
4th	98/10/16	09:14:01	147	
5th	98/10/16	09:14:01	148	
TOTAL			730	L

The logged data in block No. 3 will be displayed.

PROCEDURE	REMARKS
-----------	---------

(1) Select the [Parts] menu - [Data Logging Display] command, or click on the  icon.





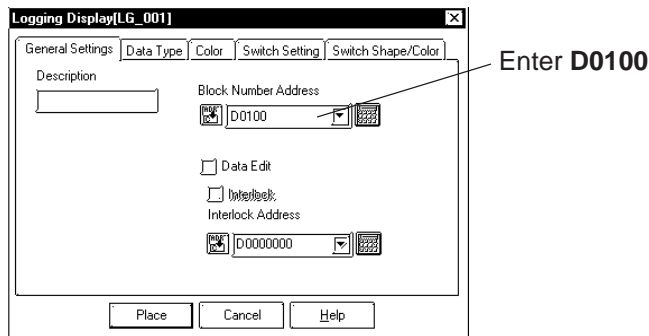

(2) In the [General Settings] tab, specify the block number designated address, data edit, and whether the interlock is enabled or disabled.  
Specify D0100 for the block number designated address.

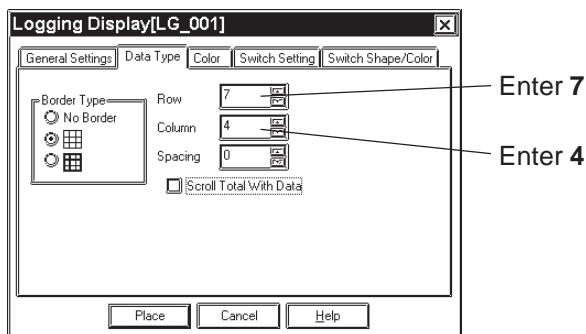
**Reference** 2.1.17 ■ Data Logging Display [General Settings] Attributes ◆ Block Number Address

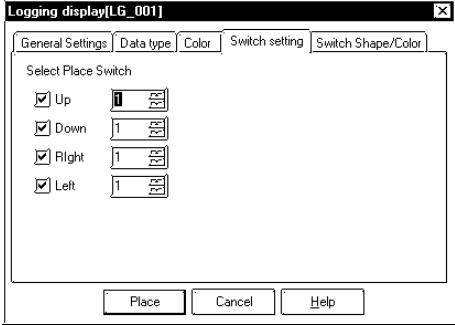

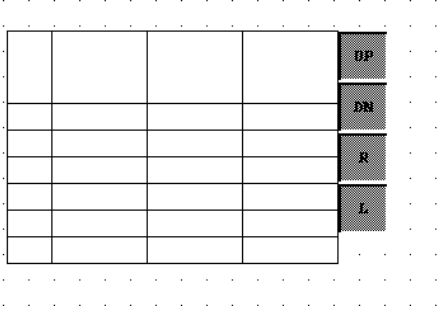
(3) In the [Data Type] tab, specify the display settings.  
If necessary, select a clear color in the [Color] tab.



PROCEDURE	REMARKS
<p>(4) In the [Switch Settings] tab, select the function switch type that is to be placed automatically, and specify the number of rows, columns scrolled.</p> <p>If necessary, select a color for the special switch in the [Switch Type/Color] tab.</p>  <p>(5) After entering and selecting all the attributes, click on the  button.</p> <p>The border of the Data Logging Display size will be displayed in the drawing area.</p> <p>(6) Click on the point where the function switch is to be placed.</p> 	<p>To cancel the placement, click on the  icon.</p> <p>The Data Logging Displays are grouped. To change any attribute, ungroup the Data Logging Displays by clicking on the  icon beforehand.</p> <p><b>Reference</b>  2.4.12 <i>Group/Ungroup</i></p> <p>If you double-click on the function switch placed on the screen, the address confirmation screen for parts will appear, enabling you to change the address.</p> <p><b>Reference</b>  2.4.14 <i>Changing Attributes</i></p>

### 2.1.18 Data Transfer Display

The Data Transfer Display allows you to manually transfer the data-transferring CSV data from the CF Card to the PLC or from the PLC to the CF Card. This area is used to display the names of the data-transferring CSV files on the CF Card and execute the transmission. When placed together with the CSV Display, the CSV file selected with the Data Transfer Display area can be viewed, edited, and printed via the data display area of the CSV Display.

**Reference** For the CSV Display, refer to *2.1.19 CSV Display*.



**Important**

- **The CSV Data Transfer function is available only on the GP2000 series.**
- **Be sure to configure the parameters of the CSV Data Transfer function and edit the CSV data before placing the Data Transfer Display on the screen.**

**Reference** For the procedures for configuring the parameters of the Data Transfer Display function and CSV data editing, refer to *Tag Reference Manual, 4.4 CSV Data Transfer Function*.



- **Do not place more than one Data Transfer Display on a single Base screen. Otherwise, a malfunction of the switch may result.**
- **Up to 32 Data Transfer Displays can be set up in one Project. When 33 or more are set up, the Data Transfer Displays will not function.**

#### ■ Data Transfer Display [General Settings] Attributes

Enter the description as necessary.

Designate a word address for the Transfer Status Address.

◆ **Transfer Status Address**

To transfer data, store the following status in the Transfer Status Address.

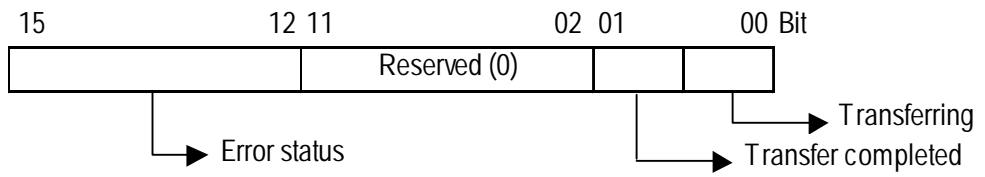

Error Code	Error Message	Description
0	Completed successfully	The processing is completed successfully.
1	Reserved	
2	No transfer condition No.	The Group No. (transfer condition No.) corresponding the file No. specified for CF-to-PLC or PLC-to-CF transfer setting does not exist.
3	LS area range error	In a CF-to-PLC data transfer in which the start address of the transfer is specified as being in the LS area, a data transfer is attempted to the address outside the specified range of the LS area.
4	No CF Card	No CF Card is inserted or cover of CF Card slot is open.
5	CF Card read error	Read-out from CF Card failed in a CF-to-PLC data transfer.
6	CF Card write error	Data writing onto the CF Card failed in a PLC-to-CF data transfer.
7	CF Card error	CF card is invalid (unformatted) or media inserted is not a CF Card.
8	Reserved	

The timing chart below shows the relationship between the data transfer and transfer status.

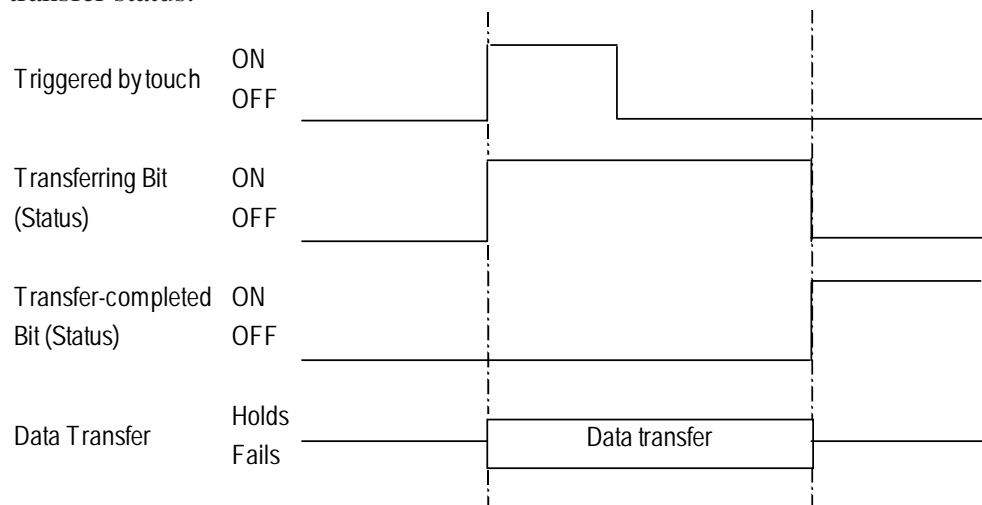

\* *The Transfer-completed bit address cannot be turned OFF via the GP side. Turn Off the bit address via the PLC.*



■ Data Transfer Display [Display] Attributes

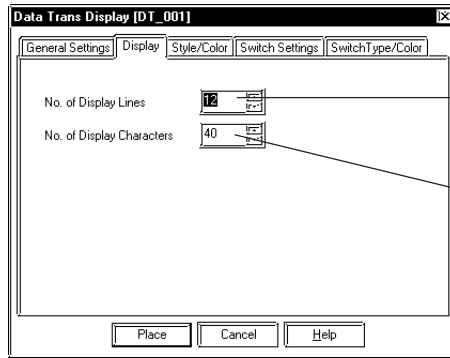

Specify the number of lines for displaying the data item (1 to 50).

Specify the maximum number of characters to be displayed in a line.

◆ No. of Display Lines

Specify the maximum number of lines for displaying messages on each screen. Up to 50 lines can be displayed on a single screen.

◆ No. of Display Characters

Specify the maximum number of single-byte characters to be displayed in a line. Up to 100 single-byte characters can be displayed per line. However, the display varies with the model.

■ Data Transfer Display [Style/Color] Attributes

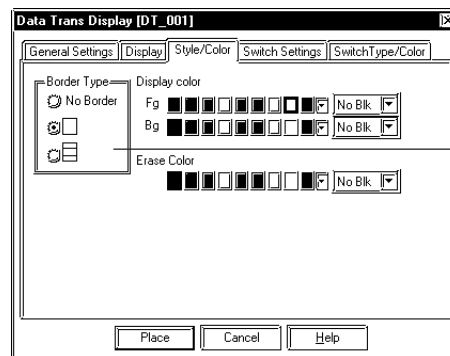

Select the desired border type for the display area.

◆ Border Type

Select from three types of borders: "No border", "Outer border", and "Outer and inner borders."

◆ Color

Select the desired text color when data are displayed (Display Color: Fg), the color inside the display area (Display Color: Bg), and the color for the display area that will be used when the data are cleared (Erase Color).

▼ **Reference** 2.1 Parts ■ **Selecting Colors**

## ■ Data Transfer Display [Switch Settings] Attributes

Configure the settings of the function switches automatically placed on the screen. **▼ Reference ▼** *2.1.3 Function Switches*

Switches for transferring data between the CF Card and PLC

Switches for scrolling and selecting data items (Data items can be scrolled between 1 and 100.)

Displays the selected CSV data on the CSV Display.

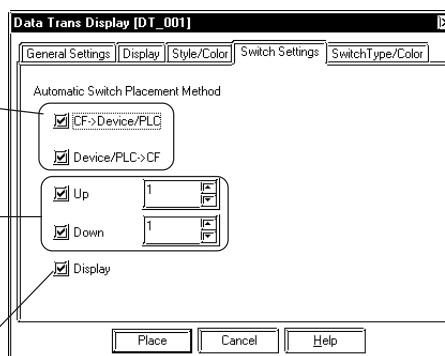

### ◆ CF → Device/PLC

Put a check mark in the checkbox to place a switch for transferring CSV files from the GP's CF Card to the PLC. When transferring two or more CSV files in one operation, select the desired files and touch the switch you have placed on the screen. **▼ Reference ▼** *Tag Reference Manual, 4.5 CSV Data Transfer Function*

### ◆ Device/PLC → CF

Put a check mark in the checkbox to place a switch for transferring CSV files from the PLC to the GP's CF Card. When transferring two or more CSV files in one operation, select the desired files and touch the switch you have placed on the screen. **▼ Reference ▼** *Tag Reference Manual, 4.5 CSV Data Transfer Function*

## ■ Data Transfer Display [Switch Type/Color] Attributes

Designate the border colors and shapes of the parts here.

**▼ Reference ▼** *2.1 Parts* ■ *Selecting Colors*

■ **Configuring a Data Transfer Display**

The procedure for configuring a Data Transfer Display is as shown below.

**<Data Transfer Display>**

00000	Unit 1
00001	Unit 2
00002	Unit 3
00003	Production Start Data
00004	Production Stop Data
00005	Test Data

CF->

->CF

UP

DOWN

DISP

**[Transferred data]**  
Data of File No. 1  
(ZR00000.CSV)

: Data	2002/1/19 9:30:00
: Group No.	1
: Group Name	Agitator No. 1
Item Name	Value
	150
	230
	300
	540
	18







**Data Transfer**

Select the data-transferring CSV file data on the CF Card (Group Name: Agitator No. 1), and touch

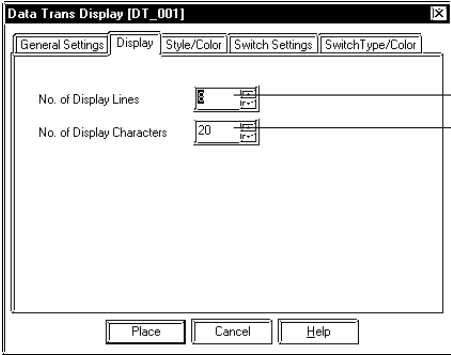
The data are transferred to the PLC according to the data transfer conditions of the specified Group Name.

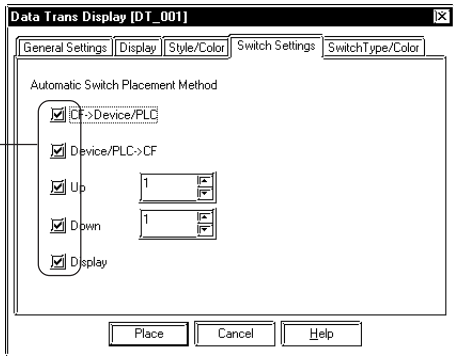
**Reference** For the procedures for transferring two or more data items and creating the data-transferring CSV data, refer to *Tag Reference Manual, 4.4 CSV Data Transfer Function.*

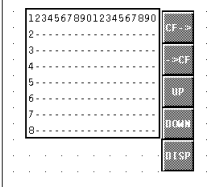
PROCEDURE	REMARKS
<p>(1) Select the [Parts] menu-[Data Transfer Display] commands, or click on the  icon.</p> <p>(2) In the [General Settings] area, set the Transfer Status Address. Enter "D0030" here.</p> <div style="border: 1px solid black; padding: 5px; margin: 10px 0;"> </div>	<p><b>Reference</b> 2.1.18 ■ <i>Data Transfer Display [General Settings] Attributes</i> ◆ <i>Transfer Status Address</i></p>

PROCEDURE	REMARKS
<p>(3) In the [Display] area, specify the number of Display Lines and number of Display Characters. Specify the borders and colors in the [Style/Color] area as necessary.</p> 	<p>In the example, the "Border Display" is designated to  (Outer and Inner borders).</p>
<p>(4) In the [Switch Settings] area, select the switches (Transfer directions, Scroll, Display) you want to place on the screen. If necessary, specify the border color and the shape of the part in the [Switch Tupe/Color] area.</p> 	<p>To cancel the placement, click on the  icon.</p> <p><b>Reference</b> To change a Part's size, refer to 2.4.3 <i>Scaling Up/Down</i>.</p> <p>Parts are grouped. To change a Part's attributes, ungroup the Parts and double-click on the desired Part on the screen.</p> <p><b>Reference</b> 2.4.14 <i>Changing Attributes</i></p>
<p>(5) After all of a Part's attributes have been entered or selected, click on the  button. A frame the size of the Transferring data display area appears in the screen creation area.</p>	<p>Do not overlap other Parts and drawings with the Transferring data display area. Be sure to use the area as a dedicated area for displaying the data.</p>
<p>(6) Click on the point where the Data Transfer Display is to be placed. Change the part size as necessary. When the Transferring data display area is scaled up/down, the size of the displayed text changes accordingly.</p> 	<p>When CSV Display is placed close to the Data Transfer Display, you can view the selected CSV file by touching the  switch on the GP screen. For details of the CSV Display setting,</p> <p><b>Reference</b> 2.1.19 <i>CSV Display</i></p>

### 2.1.19 CSV Display

The CSV file stored on the CF Card can be displayed, edited and printed with the CSV Display. Place the CSV Display together with the Data Transfer Display or File Manager Display.



- **The CSV Display feature is available only with the GP2000 series.**
- **The CSV Display will not function on Windows.**



- Only one CSV Display can be set up on each Base screen.
- The CSV Display cannot be set up simultaneously with the Logging Display, Keypad Input Display, K-tag or N699-tag.
- Do not rotate the CSV Display when placing it on the screen. Otherwise, the pop-up keypad used for editing the CSV data may not be displayed in proper orientation for the CSV Display.
- All CSV file data created with the GP can be displayed on the CSV Display as listed below.

Folder Name	File Name	Data Type
\log	ZL****.CSV	Logging Data
\trend	ZT****.CSV	Trend Graph Data
	ZS****.CSV	Sampling Data
\alarm		Alarm Data
	ZA****.CSV	◆ Alarm Active/Block 1 Data
	ZH****.CSV	◆ Alarm History/Block 2 Data
	ZG****.CSV	◆ Alarm Log/Block 3 Data

**Reference** For details of the CF Card, refer to *Tag Reference Manual, 4.7 Using the CF Card*.

- When the data currently being displayed on the CSV Display is modified (for example, when data are transferred from the PLC to the CF Card with the CSV data transfer function), the CSV Display displays the data of the CSV file from the beginning. The data currently being displayed on the CSV Display also cannot be deleted with the File Manager.

**Reference** For precautions about the display, refer to *Tag Reference Manual, 4.5.4 CSV Data Display Function (Combination)*.

## ■ CSV Display [General Settings] Attributes

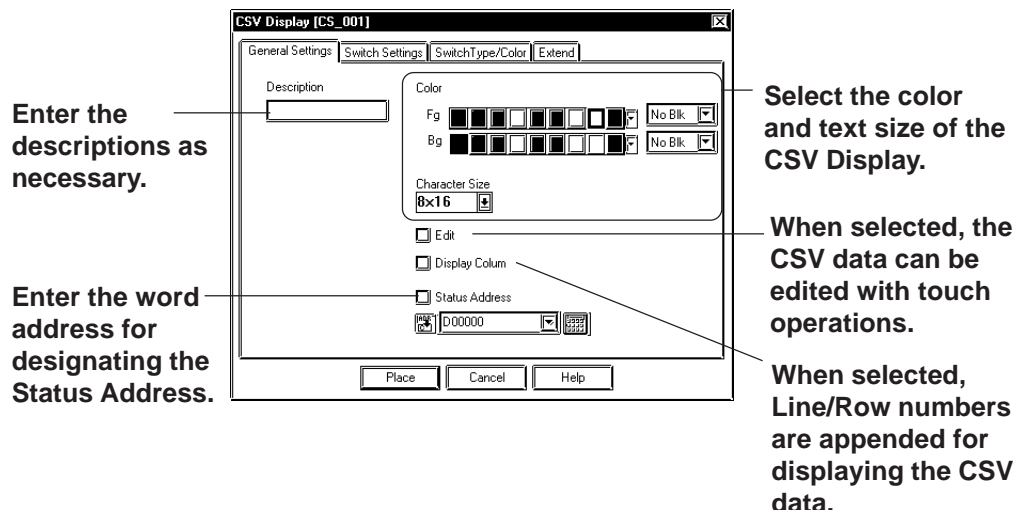

### ◆ Color

Select the colors for characters (Fg) and the background color of the display area (Bg).

▼ **Reference** ▲ 2.1 Parts ■ *Selecting Colors*

### ◆ Character Size

Specify the character size. ▼ **Reference** ▲ 2.2.9 Text

### ◆ Edit

When this function is enabled, touching the desired cell of the CSV data displayed on the CSV Display allows you to edit the data. (This function is disabled with the initial setting.)

### ◆ Display Column

When this function is enabled, the Line No. and Row No. will be displayed on the lines and rows of the CSV data display area. (This function is disabled with the initial setting.) The Line/Row numbers of the Column display are shown in bold typeface. The outer border of the Line/Row for the Column display and items are divided with 2-dot lines. The borderlines and numbers of the Column display cannot be printed.

◆ **Status Address**

When enabled, "Outputting the Edited Data" status, "Printing" status or the error status of the CF card processing is set to the specified address.

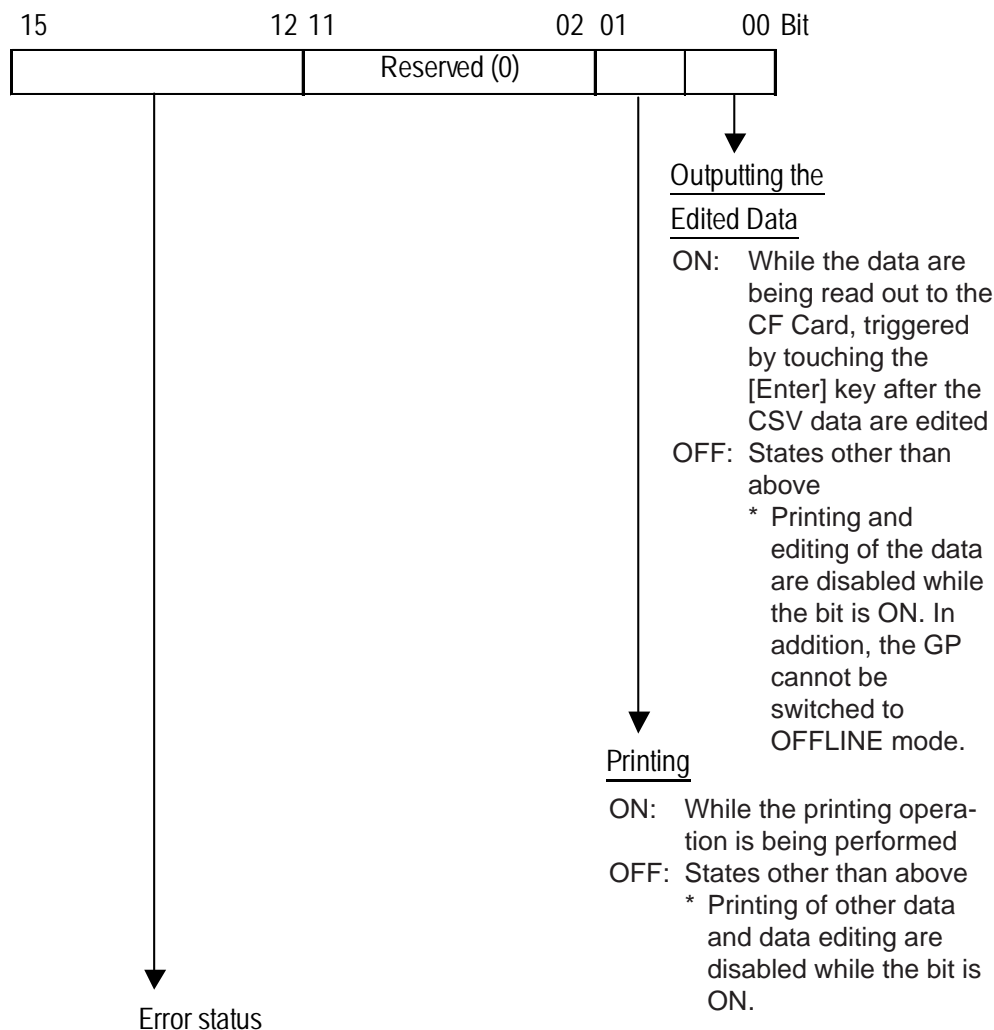

Error Code	Error Message	Description
0	Completed successfully	Processing is completed successfully.
1	Reserved	
2	Reserved	
3	Reserved	
4	No CF Card	No CF Card is inserted or cover of CF Card slot is open.
5	CF Card read error	Read-out from CF Card failed in a CF-to-PLC data transfer or the CF Card doesn't have sufficient free space.
6	CF Card write error	Data writing onto the CF Card failed in a PLC-to CF data transfer.
7	CF Card error	CF card is invalid (unformatted) or media inserted is not a CF Card
8	Reserved	

## ■ CSV Display [Switch Settings] Attributes

Switches used to scroll the items. (Specify the number of data items to be scrolled between 1 and 65,535.)

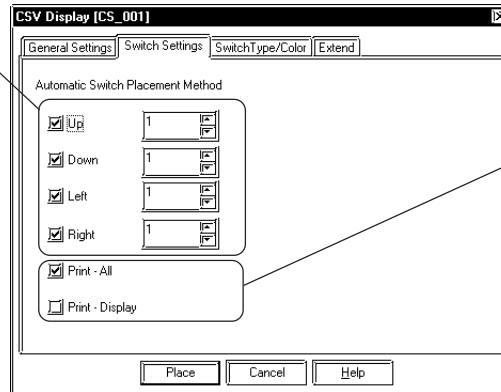

Switches used to execute print operations. Select whether to print all of the displayed CSV data or only the area displayed.

### ◆ Print

The switches are used to execute a print operation of all data of the current CSV data or only the area displayed.



- Note:**
- Up to 160 characters can be printed per line. Characters exceeding the limit are not printed.
  - The Column display is not printed.

## ■ CSV Display [Switch Type/Color] Attributes

The border colors and part types can be designated here.

**Reference** [2.1 Parts](#) ■ *Selecting Colors*

## ■ CSV Display [Extend] Attributes

When a check mark is put in the [Data Editing] checkbox on the [General Setting] area, the Interlock setting can be enabled.

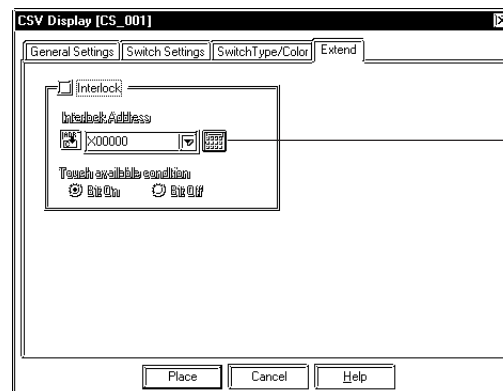

Designate whether to enable or disable the interlock function.



◆ **Interlock**

The switch becomes effective only when the bit designated via the [Interlock Address] is in a state that has been selected via the [Touch available condition]. Select whether the switch becomes effective in the state or OFF state of the [Touch available condition].

<b>Touch Available Condition</b>	<b>Interlock Address Status</b>	<b>Touch Available/Not Available</b>
Bit ON	ON	Touch available
	OFF	Touch not available
Bit OFF	ON	Touch not available
	OFF	Touch available

■ Placing a CSV Display

The procedure for configuring a CSV Display is as shown below.

Place the CSV Display along with the File Manger Display to display the specified CSV file. Similarly, the CSV Display displays the CSV file when placed in combination with the Data Transfer Display.

**Reference** For details of the File Manager Display, refer to 2.1.20 File Manager Display.

**Reference** For details of the Data Transfer Display, refer to 2.1.18 Data Transfer Display.

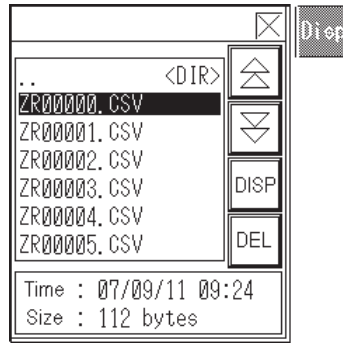

<File Manager Display>

1	2	UP
1	:DATE 2002/04/16	DN
2	:GROUP No. 1	LF
3	:GROUP NAME Unit 1	RT
4	ITEM NAME VALUE	PRN
5	300	
6	230	
7	300	
8	540	

<CSV Display>





PROCEDURE

REMARKS

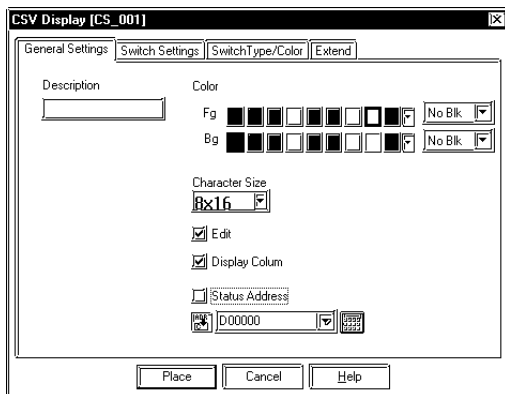
- (1) Select the [Parts] menu-[CSV Display] commands, or click on the  icon.
- (2) Specify the ON/OFF settings of Data Editing, Column Display, and Status Address on the [General Settings] area.  
Specify the Display Colors and Character Size if necessary.

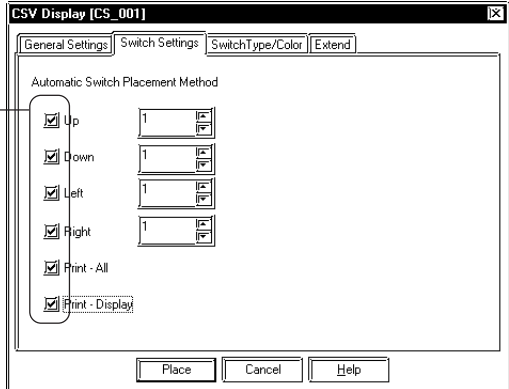
**Reference** For the procedures for setting up the File Manager Display, refer to 2.1.20 File Manager Display.

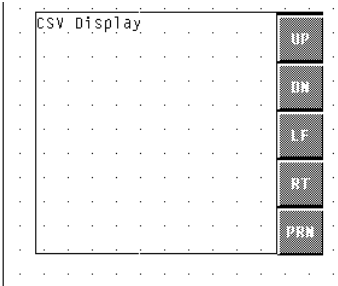

PROCEDURE	REMARKS
<p>(3) On the [Switch Settings] area, specify the switches (Scroll and Print switches) to be placed on the screen. If necessary, specify the border color and part type on the [Switch Type/Color] area.</p>  <p>(4) When [Edit] is enabled in the [General Settings] area, specify the ON/OFF status of the [Interlock] function in the [Extend] area.</p> <p>(5) After all of a Part's attributes have been entered or selected, click on the  button. A frame the size of the CSV data display area and a switch frame appears in the screen creation area.</p> <p>(6) Click on the point where the CSV Display is to be placed. Change the part size as necessary. When the CSV data display area is scaled up/down, the size of the displayed text changes accordingly.</p> 	<p>To cancel the placement, click on the  icon.</p> <p><b>Reference</b> To change a Part's size, refer to <a href="#">2.4.3 Scaling Up/Down</a>.</p> <p>Parts are grouped. To change a Part's attributes, ungroup the Parts and double-click on the desired Part on the screen.</p> <p><b>Reference</b> <a href="#">2.4.14 Changing Attributes</a></p> <p>Do not overlap other Parts and drawings with the CSV data display area. Be sure to use the area as a dedicated area for displaying the data.</p>

## 2.1.20 File Manager Display

The File Manager Display displays a list of the folder/file structure on the CF Card. Touching the Display switch displays or hides the File Manager Display in the pop-up window.

**Reference** *Tag Reference Manual, 4.6 File Manager Display Function*

When placed together with the CSV Display, the CSV file selected via the File Manager display area can be viewed, edited and printed via the data display area of the CSV Display.

**Reference** For details of the CSV Display, refer to *2.1.19 CSV Display*.



- **The File Manager Display feature is available only with the GP2000 series.**



- Only one File Manager Display can be placed on each Base screen. Even when two or more Display keys of the File Manager Display are set up/touched, the operation is interlocked with the single File Manager Display.
- The settings of the File Manager Display (shape of the display area except for the switch, borderlines and colors, etc.) cannot be edited with the Screen Creation Editor.
- The File Manager Display is displayed as a local window. If two local windows are already displayed on the screen, the File Manager Display will not appear even if the Display key of the File Manager Display is touched. In this case, the File Manager Display will not wait for input.
- When the File Manager Display and other windows overlap, touch the desired window to bring it to the front.
- When placing a U-tag on the same screen with the File Manager Display, do not specify [High Speed] in the U-tag's [Designated Window].
- When the Index Text Tables are switched, the File Manager Display is closed. To display (activate) the File Manager Display, touch the  switch again.

### ■ File Manager Display [General Settings] Attributes

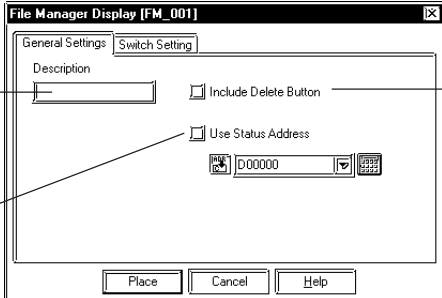

Enter a description if necessary.

Designate a word address for the Status Address.

Put a check mark to automatically place a switch that deletes the selected CSV file.

◆ **Delete button**

Deletes unwanted CSV files selected via the File Manager display area.



- The Delete button does not delete read-only CSV files.
- After deleting the unwanted file(s), the File Manager display area displays the CSV files in a list starting with the file with the oldest file No.
- When used together with the CSV Display, the CSV file currently being displayed on the CSV Display cannot be deleted.

◆ **Status Address**

Stores the status of the CF Card error code.

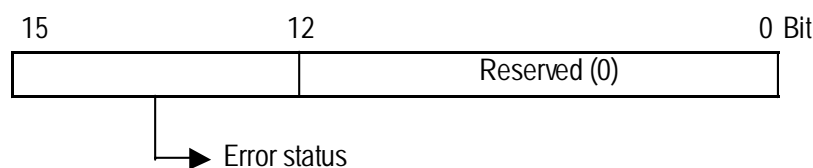

Error Code	Error Message	Description
0	Completed successfully	Processing is completed successfully.
1	Reserved	
2	Reserved	
3	Reserved	
4	No CF Card	No CF Card is inserted or cover of CF Card slot is open.
5	CF Card read error	Read-out from CF Card failed in a CF-to-PLC data transfer.
6	Reserved	
7	CF Card error	CF card is invalid (unformatted) or media inserted is not a CF Card
8	CF Card delete error	Deletion of files on CF Card failed.

■ **File Manager Display [Switch Setting] Attributes**

Put a check mark to automatically place the Display key.

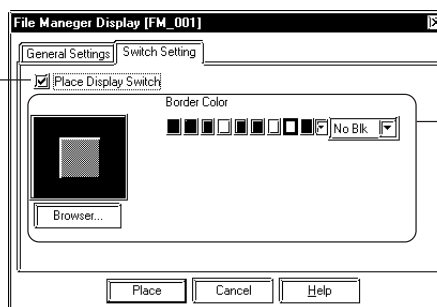



Specify the color and the switch type only when the [Place Display Switch] option is enabled.

■ **Placing a File Manager Display**

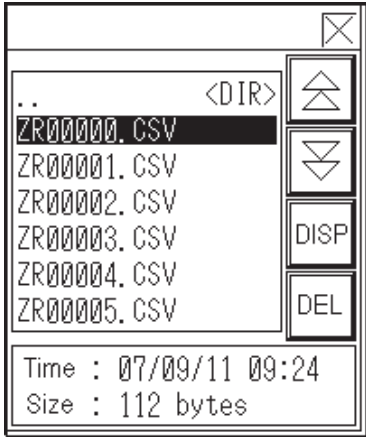
The procedure for configuring a File Manager Display is as shown below.





The File Manager Display displays the file information on the CF Card in list form. Touching the function switch (File Manager DISP) displays the File Manager Display in a pop-up window.

Use the  and  keys to scroll the list up and down.

Use the  (Display) key to select the desired file name.\*

Use the  (Delete) key to delete the specified file.

*\* When CSV Display is placed together with the File Manager Display, touching the  key on the File Manager Display after selecting the desired CSV file allows you to view, edit, and print the CSV data via the CSV Display.*

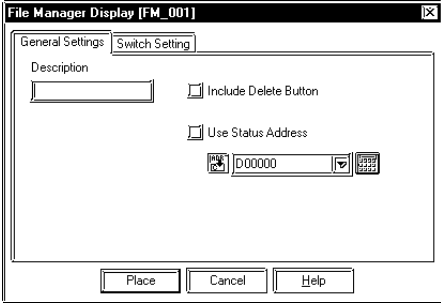
PROCEDURE	REMARKS
<p>(1) Select the [Parts] menu-[CSV Display] commands, or click on the  icon.</p> <p>(2) Specify the ON/OFF settings of the Delete button and the Status Address on the [General Settings] area. In this example, the Delete button is not placed and Status Address is set to OFF.</p> <div style="border: 1px solid black; padding: 5px; margin-top: 10px;">  </div>	

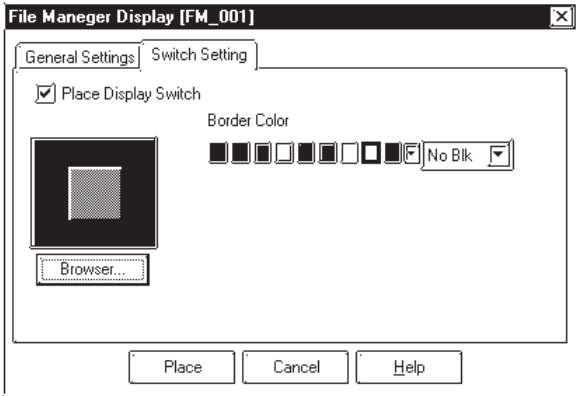
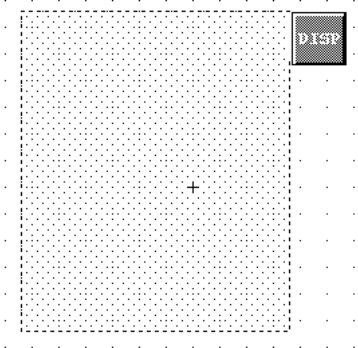
PROCEDURE	REMARKS
<p>(3) Specify the presence/absence of the Display switch in the [Switch Settings] area. If necessary, specify the part color/type as well. Here, set the Display Switch to "Present".</p>  <p>(4) After all of a part's attributes have been entered or selected, click on the <input type="button" value="Place"/> button. A frame the size of the File Manager display area and a switch frame appears on the screen creation area.</p> <p>(5) Click on the point where the File Manager Display is to be placed.</p> 	<p>Designate the point at which the File Manager Display is to be placed in 40-dot increments for the X coordinate, and 20-dot increments for the Y coordinate. If the designation of the placement position differs from the above units, the position of the File Manager Display on the GP may become misaligned.</p> <p>The File Manager Display cannot be scaled up or down.</p> <p>Parts are grouped. To change a Part's attributes, ungroup the Parts and double-click on the desired part on the screen.</p> <p><b>Reference</b> 2.4.14 <i>Changing Attributes</i></p> <p><b>Reference</b> For the operation of the File Manager Display on the GP, refer to <i>Tag Reference Manual, 4.6 File Manager Display Function</i>.</p>

**2.1.21 Numeric Displays**

This Part displays the device Word Address numeric data as an absolute value.

**■ Numeric Display [General Settings] Attributes**

Enter Comment data here

Display's the currently selected Part's image

Calls up the Part Shape Browser

Enter the Word Address where the display data is stored

◆ Word Address

Here, input the Word Address where the display data is to be stored.

**■ Numeric Display [Display Format] Attributes**

Select the Data Format and Data Length

Specify the Display Style.

Enter the total number of digits used (not including the decimal point) in the display

Enter the number of digits to be displayed after the decimal point

Select the size used for the label's characters

Supported by the GP2000 Series only

◆ Data Display Format

Here, the Data Display Format, Code, and data length are selected. Choose a data format of either Decimal (base 10), BCD, Hexadecimal (base 16), or Octal (base 8). With the Code +/- check box  checked, when you select "Decimal", negative numeric data can also be displayed.



**When using a GLC Symbol for a Word Address or a Trigger Bit Address, be sure to select "32 Bit" data display format.**



◆ **No. of Display Digits**

Here, enter the total number of digits used (not including the decimal point) in the display.



**Note:** When the No. of Display Digits is set to 5 and the Decimal Places is set to 2, a value appears on the Numeric Display as shown below.

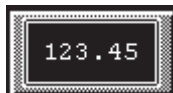

◆ **Decimal Places**

Here, enter the number of digits to be displayed after the decimal point

The types of numeric data that can be used with each data format are listed below.

Data Form	Code	Data Length	No. of Display Digits	Decimal Places	Alarm Range	
Dec	+/-	16 bit	1-5	0-4	+ only	0-65535
					+/-	-32768-32767
		32 bit	1-10	0-9	+ only	0-4294967295
					+/-	-2147483648-2147483647
BCD	+	16 bit	1-4	0-3	0-9999	
		32 bit	1-8	0-7	0-99999999	
Hex	+	16 bit	1-4	/	0-FFFF	
		32 bit	1-8		0-FFFFFFFF	
Oct	+	16 bit only	1-6		0-177777	

The relationship between upper and lower position Word Addresses when 32 bit data is used will differ depending on each Device/PLC Type.

▼ **Reference** ▲ *Device/PLC Connection Manual*

◆ **Character Size**

The label's Character Size is selected here.

▼ **Reference** ▲ *2.2.9 Text*



**Note:** Only when the GP type is the GP-77R , GP-377, or GP2000 series, is the 8 x 16 setting valid. For any GP other than the GP-77R , GP-377 or GP2000 series, selecting 8 x 16 in the editor will display 16 x 16 on the GP.

◆ **Display Style**

- **Shift Left**

- **Shift Right**

Select the display style from the Shift Left and Shift Right. The data will appear, starting from the side designated here. The Shift Right is selected by default.

- **Zero Suppress**

Select this option to omit the leading zeros of display data. E.g. When the Display Length is 4 and the Zero Suppress is NOT selected, 25 appears as 0025.

• **Zero Display**

When this option is clicked, and the device data is 0, the value 0 will display.

• **7 Segment Display**

When this option is selected, numerical values are shown on a 7-segment display. Only GP2000 Series units support the 7-segment Display. 7-segment display is possible only when the Character Size is “16X16”.

■ **Numeric Display [Shape/Color] Attributes**

Here, the Numeric Display area’s border color, value display color (Number color), and interior color (Plate color) are selected.

▼ **Reference** 2.1 Parts ■ *Selecting Colors*

■ **Numeric Display [Alarm Settings] Attributes**

If desired, specify a variety of Alarm settings.



▼ **Reference** 2.1 Parts ■ *Alarm Settings*

■ **Placing a Numeric Display**

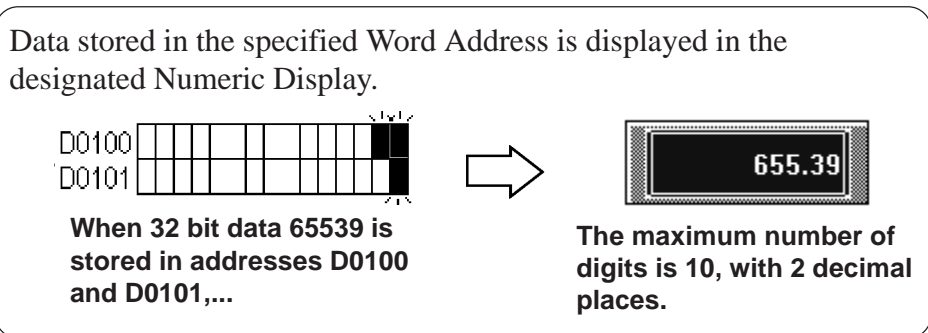
The procedure for placing a Numeric Display is shown below.

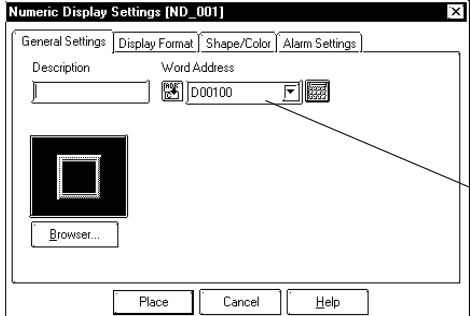

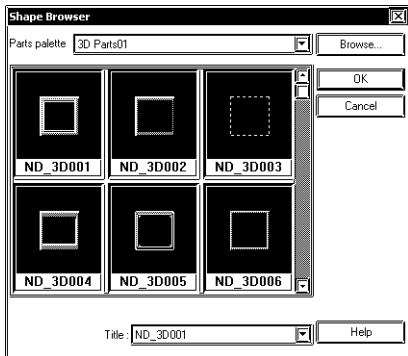
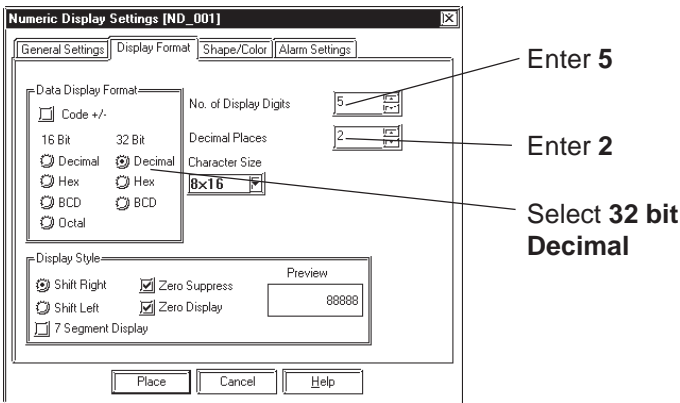
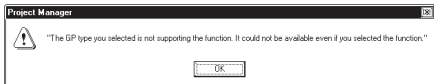
PROCEDURE	REMARKS
<p>(1) Select the [Parts] menu - [Numeric Display] command, or click on the  icon.</p> <p>(2) In the [General Settings] tab, input the Word Address used to store the display data.</p> 	

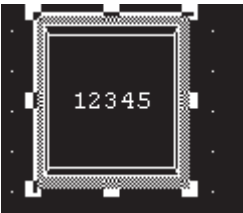
PROCEDURE	REMARKS
<p><b>(3) Select a Part Shape from the Browser.</b>                      If desired, set an Alarm and Colors from the [Alarm Settings] and [Shape/Color] area.</p> 	<p><b>Reference</b> 2.1 Parts ■ <i>Selecting a Part Shape</i></p>
<p><b>(4) In the [Display Format] area, specify the Data Display Format, and input the No. of Display Digits and the Decimal Places.</b>                      Specify the Character Size, if desired.</p> 	<p>Only the GP2000 Series supports the 7 Segment Display.</p> <p>When a GP type other than the GP2000 Series is selected and the "7 Segment Display" option is enabled, the following alarm appears.</p>  <p>To clear the alarm, disable the "7 Segment Display" option.</p>
<p><b>(5) After all of the Part's attributes have been entered and selected, click on the <b>Place</b> button.</b>                      The Numeric Display's outline will appear on the Base screen, next to your cursor.</p>	<p>To cancel the placement, click on the  icon.</p>
<p><b>(6) Click on the point where the Numeric Display's top left corner is to be placed.</b>                      If necessary, use the Numeric Display's handles to alter its size after placement.                      Regardless of whether the numeric data display area is scaled up or down, the character size will not change. To change the character size and position, select the characters inside the border directly.</p> 	<p><b>Reference</b> To change a Part's size, refer to 2.4.3 <i>Scaling Up/Down</i></p> <p>Pressing the <b>Ctrl</b> key while re-sizing an area's border will also re-size that area's characters.</p> <p>Double-clicking on any Part placed on the screen automatically calls up that Part's attribute settings.</p> <p><b>Reference</b> 2.4.14 <i>Changing Attributes</i></p>

■ Using the Time-Base function

- The Time-Base function is featured in PLCs manufactured by Siemens Corporation (S5 and S7 Series), and cannot be used with other devices. The following table lists the supported protocols:

Siemens AG	SIEMENS S5 90-115 Series
	SIEMENS S5 135-155 Series
	SIEMENS S5 3964 (R) Protocol
	SIEMENS S7-200 PPI
	SIEMENS S7-200 via MPI
	SIEMENS S7-300/400 (ETHER)
	SIEMENS S7-300/400 via MPI
	SIMATIC S7 via 3964/RK512
PROFIBUS	PROFIBUS-DP

- This function is supported only by GP2000 Series (except for the GP2000H Series) and ST Series.
- A total of 16 bits of data are used, with the upper four bits showing the Time-Base mode, and the remaining 12 bits showing the display data. These 12 bits are processed using 3 digits of BCD data.
- Time-Base data can have decimal points, spaces or zeroes (“0”), with the character “s” always included on the right. (See table below)

Upper 4 bits	Remaining (Lower) 12 bits			Display Range
Time-Base Mode	BCD (3 digits)			
0 (0.01s)	0 to 9	0 to 9	0 to 9	0.00s to 9.99s
1 (0.1s)				0.0s to 99.9s
2 (1s)				0s to 999s
3 (10s)				0s to 9990s



**Note:** If the digit entered for the Time-Base mode is not 0, 1, 2, or 3, it is treated as “3”.

Clicking the “Time-Base” selection in the Numeric Display Part’s Display Format tab, enables the Time-Base function.

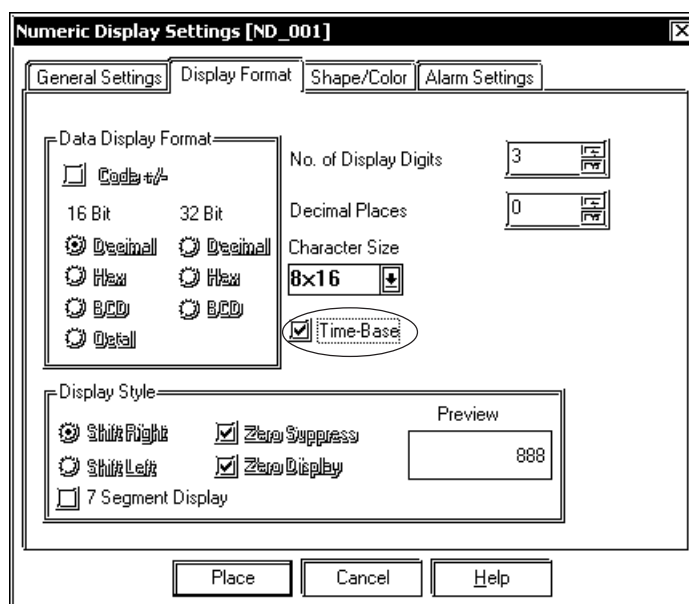

**2.1.22 Message Display**

This display is used to show single-line alarm messages in response to changes in the device Word Address data. Select the message from Direct Text or Text registered in the Text Table Editor.



**Text registered in the Text Table Editor is available only with GP377/GP77R/GP2000 Series units.**

**Message Display [General Settings] Attributes**

The screenshot shows the 'Message Display Settings [MW\_001]' dialog box. It has two tabs: 'General Settings' and 'Messages'. The 'Messages' tab is active, showing a 'Description' field, an 'Address' field with a dropdown menu set to 'Bit' and a numeric input '000000', and a 'Mode' section with radio buttons for 'Bit' and 'Word'. Below these are 'Border Color' (a color palette), 'Center Arrangement' (a checked checkbox), 'Alignment' (three icons for left, center, and right), and 'Character Size' (a dropdown menu set to '8x8'). At the bottom are 'Place', 'Cancel', and 'Help' buttons. Callouts point to various elements: 'Enter Comment data here' points to the Description field; 'The currently selected Part Shape is displayed here' points to a square icon; 'Calls up the Part Shape Browser; Part Shapes can be selected directly from the Browser' points to a 'Browser...' button; 'Centers the Text registered in the Text Table Editor within a box/border' points to the 'Center Arrangement' checkbox; 'Select the Word or Bit Address to be monitored' points to the Address field; 'Select a Border color' points to the 'Border Color' palette; 'Select the type of alignment desired for the text of the Display' points to the 'Alignment' icons; 'Select the Operation Mode' points to the 'Mode' radio buttons; and 'Select a Character Size' points to the 'Character Size' dropdown.

◆ **Address**

Enter an Address to be monitored. Select either Bit Address or Word Address according to (operation) Mode.

◆ **Border Color**

The Message Display's Border color can be selected.

**Reference** 2.1 Parts ■ *Selecting Colors*

◆ **Center Arrangement**

When this feature is enabled, the text block of the text registered in the Text Table Editor is centered within a box/border. This feature is only available for when signifying the text in [Browse Text Table].

**Reference** 4.6.3 ■ *Selecting the index character string*

◆ **Alignment**

Here, the text's alignment can be selected.

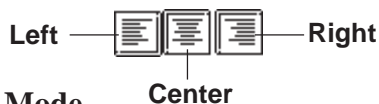

◆ **Mode**

There are two methods to change messages displayed on the Message Display, i.e. via Bit's turning ON/OFF and Word state changes. Here, select either mode.

**Mode: When selecting Bit**

Messages will change according to the specified Bit Address's ON/OFF changes.

**Mode: When selecting Word**

Messages will change according to the state changes of the designated bits, consecutively from the specified Address's 00 bit. According to the number of the messages (either 2, 4, 8, or 16), a bit is automatically assigned from the specified Address's 00 bit.

Numbers of Messages	Number of Bits Used
2	1
4	2
8	3
16	4

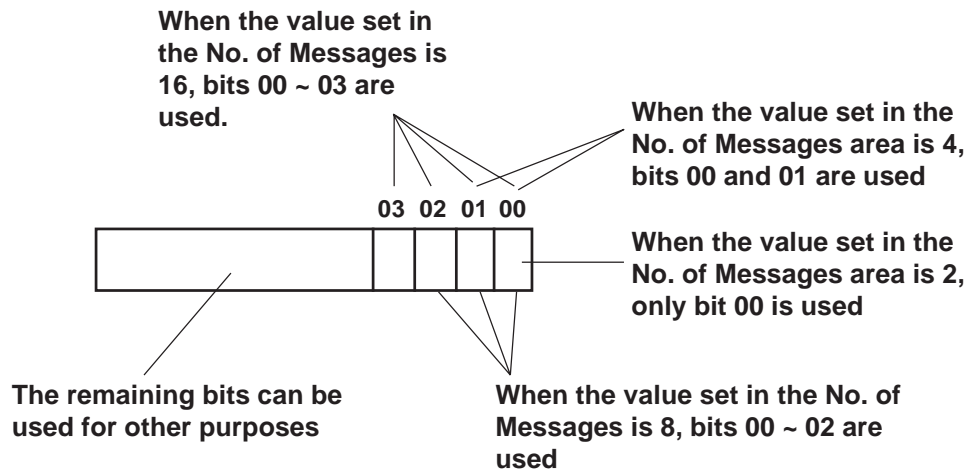

## ■ Message Display [Messages] Attributes

(Operation Mode example: When using Word Address)

The screenshot shows the 'Message Display Settings [MW\_001]' dialog box. It has two tabs: 'General Settings' and 'Messages'. The 'Messages' tab is active, showing options for 'Direct' and 'Browse Text Table'. The 'Direct' option is selected. Below this are fields for 'No. of Messages' (set to 4) and 'Display Characters' (set to 10). A 'Message' field contains '0 1 2 3'. There are 'Style' options: 'Normal' (selected), 'Bold', and 'Raised'. A 'Color' section has 'Text Color' and 'Plate Color' dropdowns, both set to 'No Blk'. A 'Selected Message' field contains 'Undefined'. There are 'Delete', 'Copy from Description', and 'Copy to All' buttons. At the bottom are 'Place', 'Cancel', and 'Help' buttons.

Annotations for the screenshot:

- Select the text type for the message entry. (Points to the 'Direct' radio button)
- Enter the message's text here. (Points to the 'Selected Message' field)
- Deletes the currently selected message, and specifies the message (and its color) as undefined. (Points to the 'Delete' button)
- Enter the number of messages (states) here. (Points to the 'No. of Messages' field)
- Enter the maximum number of characters only when "Direct Text" is selected. (Points to the 'Display Characters' field)
- The state indication buttons appear according to the No. of Messages. (Points to the 'Message' field)
- Select the Character Type. (Points to the 'Style' section)
- Select the message's (display) Color. (Points to the 'Color' section)
- Copies all the characters in the Selected Message field to all states only when "Direct Text" is selected. (Points to the 'Copy to All' button)
- Copies the characters in the Description field to the Selected Message field only when "Direct Text" is selected. (Points to the 'Copy from Description' button)

### ◆ Direct

The text entered in the Selected Message field is placed directly as fixed character strings.

The message is displayed in a single line. Up to 16 types of messages can be displayed in each Message Display.

### ◆ Browse Text Table

Select or add the Text registered in the Text Table Editor. Two or more lines of messages can be displayed.

▼ **Reference** 4.6.3 ■ *Selecting the character string* ◆ *Entering the character string*

### ◆ No. of Messages

The number of the messages (number of states) can be selected from 2, 4, 8, and 16.

### ◆ Display Characters

Here, the maximum number of characters displayed in a message is selected. Up to 40 characters can be input. If the number of a message characters exceeds the specified value, characters that do not fit in the area will be truncated.

◆ **Message**

According to the No. of Messages, designate a message for each state.

**Operation Mode: Bit**  Off  On

Designate a message for each state (ON and OFF).

**Operation Mode: Word**  0  1  2  3

As many buttons as the number of the specified messages will be displayed.

Designate a message for each state.

◆ **Selected Message**

Enter the message in this field with the "Direct" option selected. After entering a message, the message will be displayed in the selected color(s).

The default value setting is "Undefined".

▼ **Reference** ▲ To select the "Browse Text Table" option, refer to **4.6.3**  
 ■ *Selecting the character string* ◆ *Entering the character string*.

◆ **Color**

Here, each message's display colors can be selected.

Default settings are = Char. color - White; Plate (background) color - Blue.



**■Placing a Message Display**

The Message Display setting procedure is shown below. (When using a Word Address in "Direct Text" mode)

Message No. 0 (When the data in the Word Address is "0"):	None	
Message No. 1 (When the data in the Word Address is "01"):	Signal A Operation	
Message No. 2 (When the data in the Word Address is "10"):	Signal B Operation	
Message No. 3 (When the data in the Word Address is "11"):	Signal A & B Operation	



...displays in response to changes in the Word Address data.

→

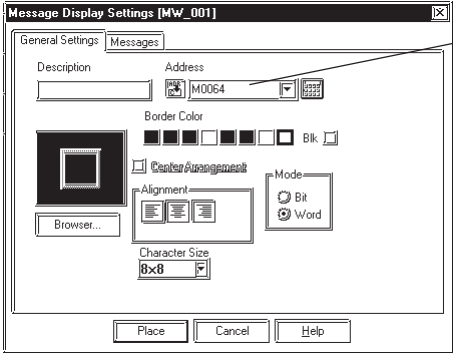
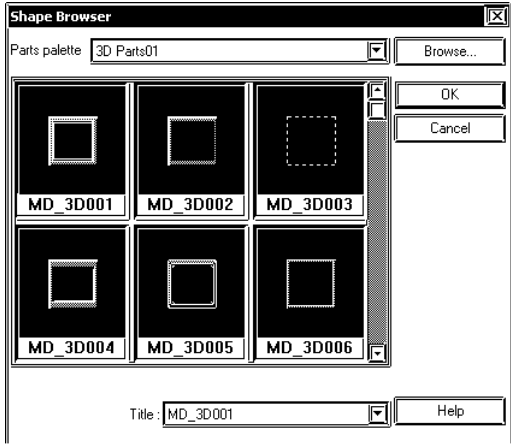
A message from those listed above, allocated to the specified Word Address...

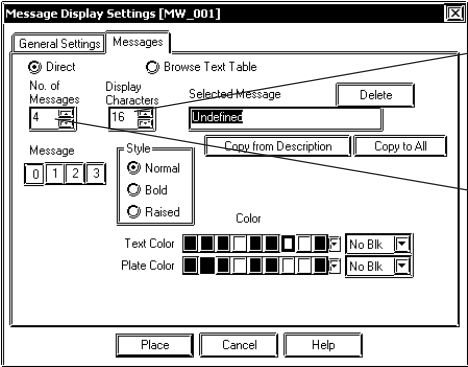
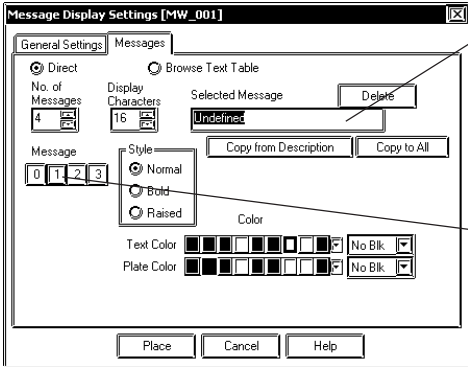
PROCEDURE	REMARKS
<p>(1)Select the [Parts] menu - [Message Display] command, or click on the  icon.</p> <p>(2)In the [General Settings] tab, input a Word Address. Select the message's Border Color, Text Alignment and Character Size, if desired.</p>  <p>Enter M0064</p>	<p>If the message is displayed on more than one line with the Index character strings, the characters are always center-aligned.</p> <p>When a string registered in the String Table Editor requires more than one sentence, the alignment becomes "Centered".</p>
<p>(3)Select a Part Shape from the Browser.</p> 	<p><b>▼Reference</b> 2.1 Parts ■ <i>Selecting a Part Shape</i></p>

PROCEDURE	REMARKS
<p>(4) Enter the number of Messages and number of Display Characters with the "Direct Text" option selected in the [Message] area.</p>  <p>Enter 16</p> <p>Enter 4</p> <p>(5) Enter your Alarm Messages.                  Select the message number to be registered and enter the message. When displaying a border with no message, be sure to delete the words "Undefined". Select Colors and Character Size, if necessary.                  (Example) When registering the message "A Unit Operating" as message Number 1:</p>  <p>Enter A Unit Operating</p> <p>Select 1</p> <p>(6) After all of the Part's attributes have been entered and selected, click on the <input type="button" value="Place"/> button.                  The Message Display's outline will appear on the Base screen, next to your cursor.</p>	<p><b>Reference</b> If selecting the "Browse Text Table" option, refer to 4.6.3 ■ Selecting the character string ◆ Entering the character string.</p> <p>Any characters entered that are over the limit specified in step (4) will be cut from the GP's display.</p> <p>If the text "Undefined" is not deleted, it will be registered and then displayed as a message.</p>

PROCEDURE	REMARKS
<p>(7) Click on the point where the Message Display's top left corner is to be placed on the Base Screen.</p> <p>If necessary, use the Message Display's handles to alter its size after placement.</p> <p>The message, corresponding to the message number designated in the Dialog box, is displayed on the Message Display.</p> <p>Regardless of whether the Message Display is scaled up or down, the character size will not change. To change the character size and position, directly select a character inside the text box.</p> 	<p>To cancel the placement, click on the  icon.</p> <p><b>Reference</b> To change the Part's size, refer to <b>2.4.3 Scaling Up/Down</b></p> <p>When the Message Display is scaled up (larger), the message characters may not be displayed in the correct position. In that case, use the pull down menu [Edit] menu's [Align...] command to adjust the position.</p> <p><b>Reference</b> <b>2.4.9 Align</b></p> <p>Double-clicking on any Part placed on the screen automatically calls up that Part's Attribute Settings dialog box. Also, clicking on the message numbers allows you to view the message's display status.</p> <p><b>Reference</b> <b>2.4.14 Changing Attributes</b></p>



- Changing the state via the Parts State Change Tool Bar after placing a Part allows you to check each state's Library display condition.
- Every time a part's screen is opened, the Part's state will be reset to 0.
- If a state which has not been defined is designated, the Message Display may show nothing. For example, when the number of messages is 16 and only states 0 to 3 actually have a message registered, designating states 4 to 15 displays only message frames.

### 2.1.23 Date Displays

Date display data is created using the GP's internal calendar and formatted as;

February 11th, 2001, or 01/02/11; however, the date format can be changed.

#### ■ Date Display [General Settings] Attributes

The screenshot shows the 'Date Display Settings [DD\_001]' dialog box. It has a 'General Settings' tab. The 'Description' field is empty. The 'Character Size' is set to '8x16' and the 'Date Format' is 'yy/mm/dd'. There is a checkbox for '7Segment Display' which is checked. Below this are three color selection fields: 'Border Color', 'Text Color', and 'Plate Color', each with a color palette and a 'No Blk' option. At the bottom are 'Place', 'Cancel', and 'Help' buttons. Annotations point to various parts of the dialog:

- 'Enter Comment data here' points to the 'Description' field.
- 'The currently selected Part's image is displayed here' points to a small square icon in the center.
- 'Calls up the Part Shape Browser. Parts can be selected directly from the Browser' points to the 'Browser...' button.
- 'Select the Data Format' points to the date format dropdown.
- 'The time is shown on a 7-segment display. Supported by the GP2000 Series only.' points to the '7Segment Display' checkbox.
- 'Select the Border (frame), Text and Plate (background) colors' points to the color selection fields.

#### ◆ Data Format

The following display formats are available:

yy/mm/dd  
 dd/mm/yy  
 mm/dd/yy  
 20yy/mm/dd\*<sup>1</sup>  
 dd/mm/20yy\*<sup>1</sup>  
 mm/dd/20yy\*<sup>1</sup>

(yy: year, mm: month, dd: day)

#### ◆ Color

The Date Display's border color, character display color (Text), and interior color (Plate) can be selected here.

**Reference** 2.1 Parts ■ *Selecting Colors*

#### ◆ Character Size

The label's Character Size is selected here.

**Reference** 2.2.9 *Text*

#### ◆ 7 Segment Display

When this option is selected, numerical values are shown on a 7-segment display. Only the GP2000 Series supports the 7 Segment Display.



\*1 The characters used for the display of 2000's first two characters ("20") are single-byte characters.

■ **Placing a Date Display**

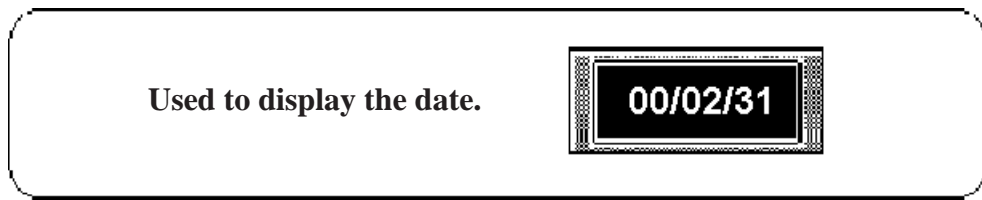
The Date Display placement procedure is shown below.

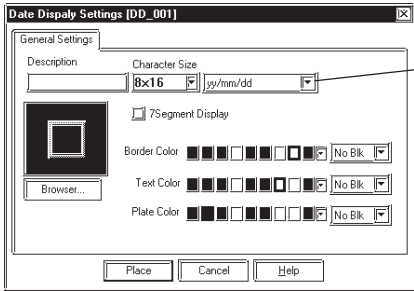
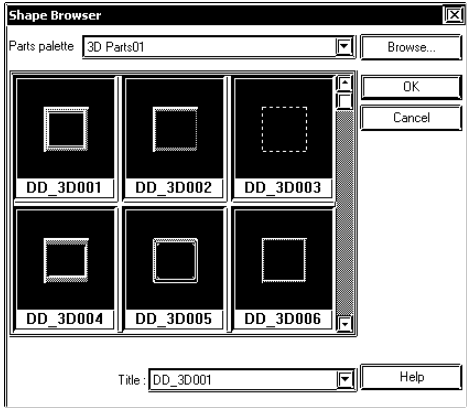
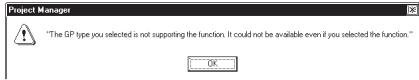

PROCEDURE	REMARKS
<p>(1) Select the [Parts] menu - [Date Display] command, or click on the  icon.</p> <p>(2) In the [General Settings] area, select a display format.</p>  <p>(3) Select a Part Shape from the Browser. If desired, select Colors and Character Size.</p>  <p>(4) After all of the Part's attributes have been entered and selected, click on the [Place] button. The Date Display's outline will appear in the Base screen, next to your cursor.</p>	<p>Only the GP2000 Series supports the 7 Segment Display.</p> <p>When a GP type other than the GP2000 Series is selected and the "7 Segment Display" option is enabled, the following alarm appears.</p>  <p>To clear the alarm, disable the "7 Segment Display" option.</p> <p><b>Reference</b> 2.1 Parts ■ <i>Selecting a Part Shape</i></p>

PROCEDURE	REMARKS
<p>(5) <b>Click on the point where the Date Display's top left corner is to be placed.</b></p> <p>If desired, use the Date Display's handles to alter its size. Regardless of whether the Date Display is scaled up or down, the character size will not change. To change the character size and position, directly select the characters inside the border.</p> 	<p>To cancel the placement, click on the  icon.</p> <p><b>Reference</b> To change a Part's size, refer to <b>2.4.3 Scaling Up/Down</b></p> <p>Double-clicking on any Part placed on the screen automatically calls up that Part's attribute settings.</p> <p><b>Reference</b> <b>2.4.14 Changing Attributes</b></p> <p>When scaling up or down the display area, if the  key is pressed at the same time, the characters will scale in unison with the border.</p>

**2.1.24 Time Displays**

Time Display areas can be created, based on the GP's internal calendar function. Time will be expressed in 24 hour format.

(E.g.) 2:25 pm → 14:25

Only one Time Display Part can be used per screen.

**Time Display [General Settings] Attributes**

The screenshot shows the 'Time Settings [TD\_001]' dialog box with the following callouts:

- Enter Comment data here:** Points to the 'Description' text field.
- The currently selected item's image appears here:** Points to a preview window showing a square with a border.
- Character Size:** Points to the 'Character Size' dropdown menu, which is set to '8x16'.
- Supported by the GP2000 Series only:** Points to the 'Seconds Display' and '7Segment Display' checkboxes.
- The time is also shown in seconds:** Points to the 'Seconds Display' checkbox.
- The time is shown on a 7-segment display:** Points to the '7Segment Display' checkbox.
- Select Border, Character, and Plate colors:** Points to the 'Border Color', 'Text Color', and 'Plate Color' color selection grids.
- Calls up the Part Shape Browser. Part Shapes can be selected directly from the Browser:** Points to the 'Browser...' button.

◆ **Color**

Here, the Time Display's Border color, character display color (Text), and background color (Plate) can each be selected.

**Reference** 2.1 Parts ■ *Selecting Colors*

◆ **Character Size**

The label's Character Size is selected here.

**Reference** 2.2.9 *Text*

◆ **Seconds Display**

The time is also shown in seconds. This feature is only available with the GP2000 Series.

Example: To display "nine twenty-five and ten seconds": → 09:25:10

◆ **7 Segment Display**

When this option is selected, numerical values are shown on a 7-segment display. Only the GP2000 Series supports the 7 Segment Display.



**Note:** When a GP type other than the GP2000 Series is selected and the "Seconds Display" and "7 Segment Display" options are enabled, the following alarm appears.

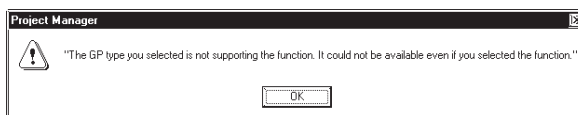





To clear the alarm, disable the "Seconds Display" and "7 Segment Display" options.

■ **Placing a Time Display**

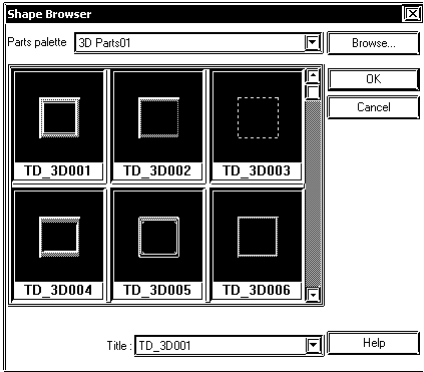
The Time Display is placed using the following procedure.

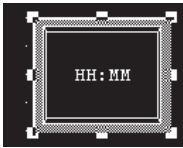

PROCEDURE	REMARKS
<p>(1) Select the [Parts] menu - [Time Display] command, or click on the  icon.</p> <p>(2) Select a Part Shape from the Browser. If desired, select Colors and Character Size.</p>  <p>(3) After all of the Part's attributes have been entered and selected, click on the  button. The Time Display Part's outline will appear on the Base screen, next to your cursor.</p> <p>(4) Click on the point where the Time Display's top left corner is to be placed. Change the size if necessary. Regardless of whether the Time Display is scaled up or down, the character size will not change. To change the character size and position, select the characters directly.</p> 	<p><b>Reference</b> 2.1 Parts ■ <i>Selecting a Part Shape</i></p> <p>To cancel the placement, click on the  icon.</p> <p><b>Reference</b> To change a Part's size, refer to 2.4.3 <i>Scaling Up/Down</i></p> <p>When scaling up or down the display area, if the  key is pressed simultaneously, the characters are also scaled up or down together with the border.</p> <p>Double-clicking on any Part placed on the screen automatically calls up that Part's attribute settings.</p> <p><b>Reference</b> 2.4.14 <i>Changing Attributes</i></p>



### 2.1.25 Picture Displays

Registered Library items are displayed according to device Word Address changes. Parts and Tags, however, cannot be displayed in these displays. Up to 16 different kinds of Library items can be displayed on a single

**Reference** y.

2.5 Libraries



**The Picture Displays will not be displayed on the GP when transferred, if the GP has not been connected to the PLC yet.**

#### Picture Display [Description] Attributes.

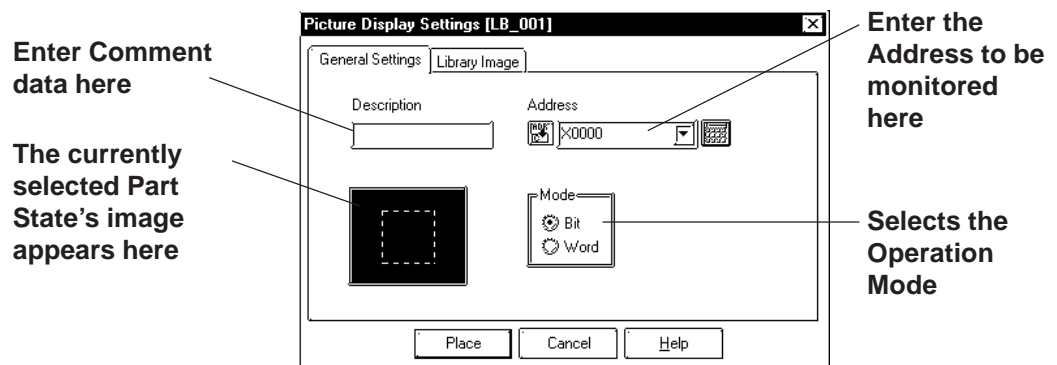

#### ◆ Address

Here, either a Bit or Word Address is entered, after first selecting a Type (either Bit or Word).

#### ◆ Mode

There are two methods used to switch the Library images displayed on the Picture Display; one is Bit access and the other is Word access. Select either of these.

#### Mode: When selecting Bit

Messages will change according to the specified Bit Address's ON/OFF changes.

**Mode: When selecting Word**

Messages will change according to the state changes of the designated bits, consecutively from the specified Address's 00 bit. According to the number of the messages (either 2, 4, 8, or 16), a bit is automatically assigned from the specified Address's 00 bit.

Numbers of Messages	Number of Bits Used
2	1
4	2
8	3
16	4

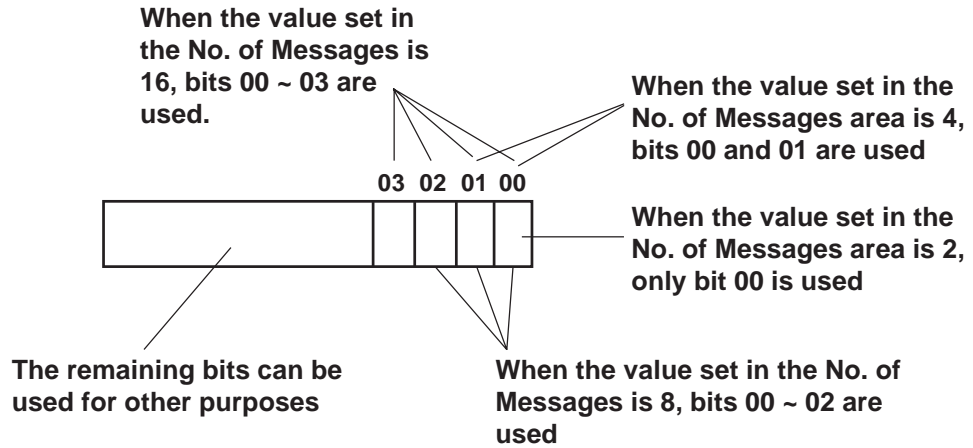

■ **Picture Display [Library Image] Attributes**

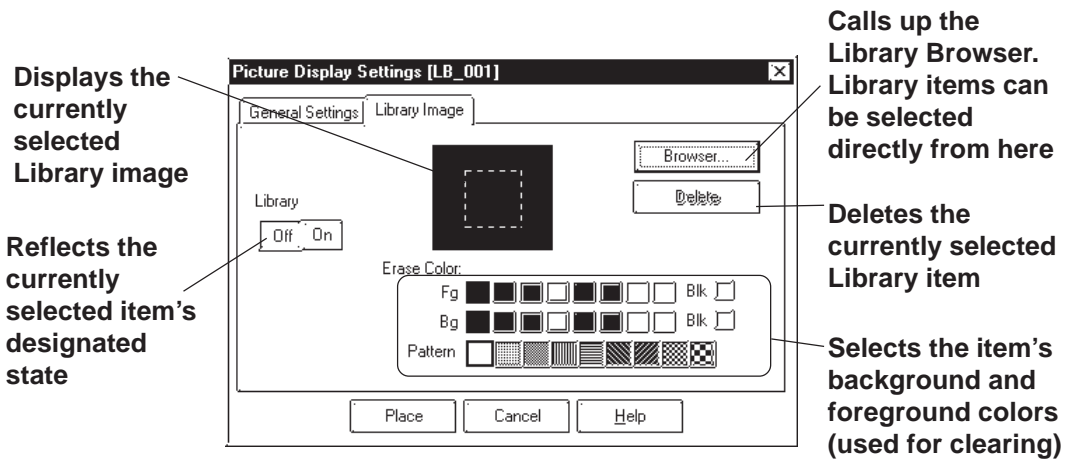

◆ **Browser**

When clicking on the  button, the Library Browser (Library list) will appear. Select a desired Library from this list and drag it to the inside of the Library image display border on the Dialog box.

▼ **Reference** 2.5 Libraries

◆ **Delete**

The selected Library item is deleted and the display will disappear.

◆ **No. of Lib.**

Displays only when Type's Word is selected. The number of Library images (number of states) to be displayed on the Picture Display can then be input. Select any of 2, 4, 8, or 16.

◆ **Library**

Here, the Library item used for each state is specified. Settings will differ depending on the Type selection.

**Mode: When selecting Bit**

Specify a Library item's ON and OFF states, respectively.

**Mode: When selecting Word**

The number of buttons will match the designated number of Library items. Specify a Library item for each state.



**Changing the state via the Parts State Change Tool Bar after placing a Part allows you to check each state's Library display condition.**

◆ **Color**

The background square colors (Clear Fg, Clear Bg) and pattern (Pattern) are selected. The default settings are black. The square colors can be selected so as to match the Picture Display placement area background's color.

**<Back Ground Square>**

The Library item to be displayed while the GP is running needs the filled square for the background to be the rearmost, so that the items(images) do not overlay each other when they are switched. When designating a Library item, the GP-PRO/PBIII for Windows program will draw this colored square automatically.

Right after the Library item(s) is/are placed, the background square will match the size of the largest Library item designated. After the items are placed, it can be scaled larger or smaller, independently from the Library items.



For a state with no designated Library item, only a background square will be displayed and it will become the Library's deletion screen, i.e. it will be overlaid on top of an existing item to "delete" that item.

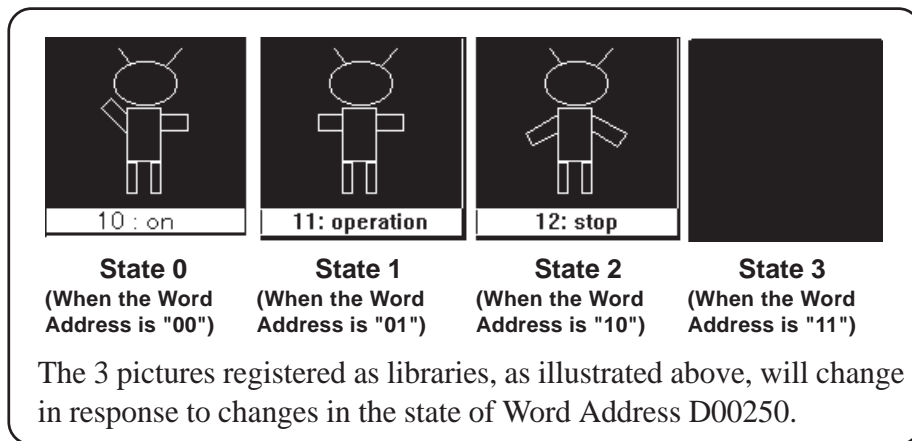

■ Placing a Picture Display

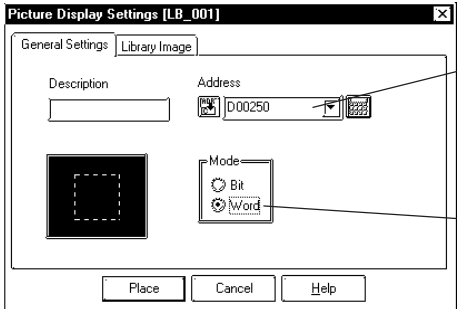
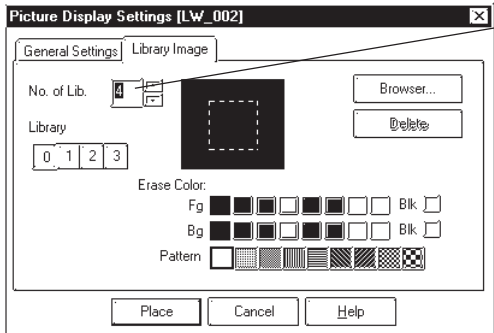
The Picture Display's creation procedure is shown below.

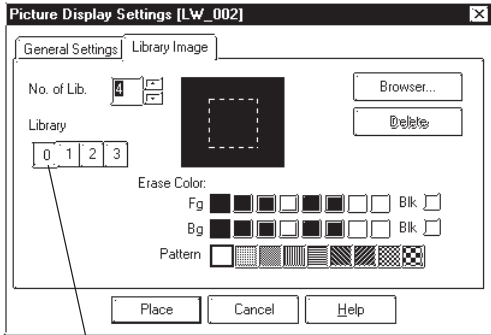
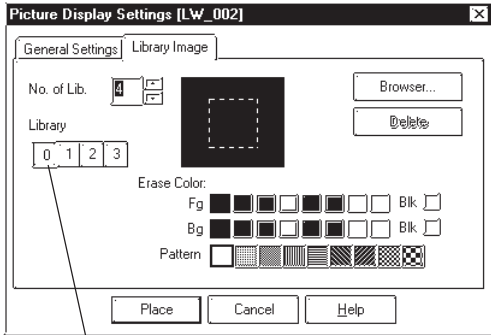

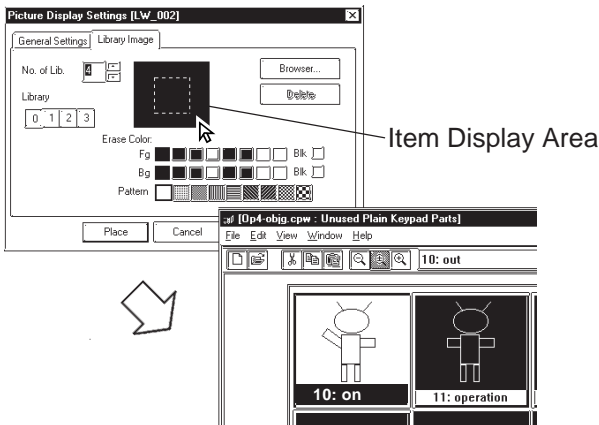
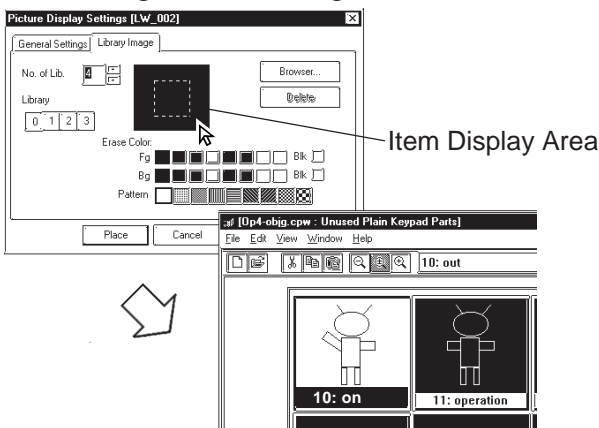
PROCEDURE	REMARKS
<p>(1) Select the [Parts] menu - [Picture Display] command, or click on the  icon.</p> <p>(2) In the [General Settings] area, enter an Address and select a Mode.</p>  <p>(3) In the [Library Image] area, input the No. of library items (No. of Lib.) used.</p> 	

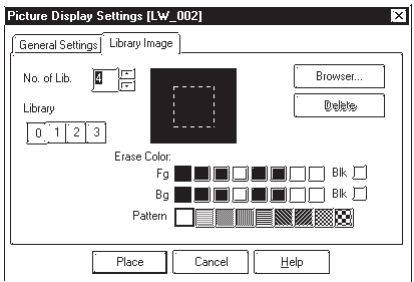
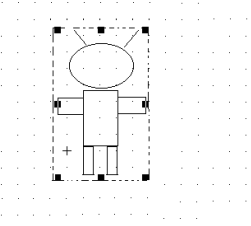
PROCEDURE	REMARKS
<p>(4) Select a state (to register an item as), and then click on the  button. Here, perform settings for state 0.</p>  <p>Select 0</p>	
<p>(5) Select a Library to be displayed for state 0 from the Browser.</p> 	<p><b>Reference</b> 2.5 Libraries</p> <p>To select a Library from a file different from the currently displayed one, click on the Library Browser's  icon.</p>
<p>(6) Drag the selected item to the Dialog box's black item display area. Select foreground or background Colors, if desired.</p>  <p>Item Display Area</p>	<p><b>Reference</b> 2.5 Libraries</p>

PROCEDURE	REMARKS
<div style="text-align: center; margin-bottom: 10px;">  </div>  <p><b>(7)For States [1] and [2], repeat steps (4) ~ (7). Since State [3] is used to delete Library item from the screen, nothing is specified for it.</b></p> <p><b>(8)After all of the item's attributes have been entered and selected, click on the [Place] button.</b> The Picture Display's outline will appear on the Base screen, next to your cursor.</p> <p><b>(9)Click on the point where the Picture Display's top left corner is to be placed.</b> Here, the Picture Display's border (dotted line or filled square) and the Library item will appear. At this time, the Library item corresponding to the state currently selected in the Dialog box is displayed on the Picture Display. Regardless of whether the Picture Display's border is scaled up or down, the Library item's size will not change. The border size is common through all the Libraries. The Library item's size and position can be altered by clicking directly on its inside border.</p> <div style="text-align: center; margin-top: 20px;">  </div>	<p>To delete a Library item, click on the  button.</p> <p>To cancel the placement, click on the  icon.</p> <p>Double-clicking on any Part placed on the screen automatically calls up that Part's attribute settings. Also, switching the states allows you to view the Library display status.</p> <p><b>Reference</b> 2.4.14 <i>Changing Attributes</i></p> <p>Changing the state via the Parts State Change Tool Bar after placing a Part allows you to check each state's Library display condition.</p>



- Every time the screen is opened, the state will be reset to 0.
- If a state with no Library registered is designated, nothing will be displayed on the Picture Display. For example, when the number of messages is 16 and only states 0 to 3 actually have a message registered, designating states 4 to 15 displays only background square frames.

**2.1.26 Window Parts**

Calls up the window onto the Base Screen (B). Register the windows to the Window Registration via the Window Screen (U). This operation is easier than using the U-tag.

**■ Window Parts Attributes**

Enter comment data here.

This displays the Window Number of the window registered on the Window Screen (U).

Select the Window Number you want to call up onto the Base Screen (B).

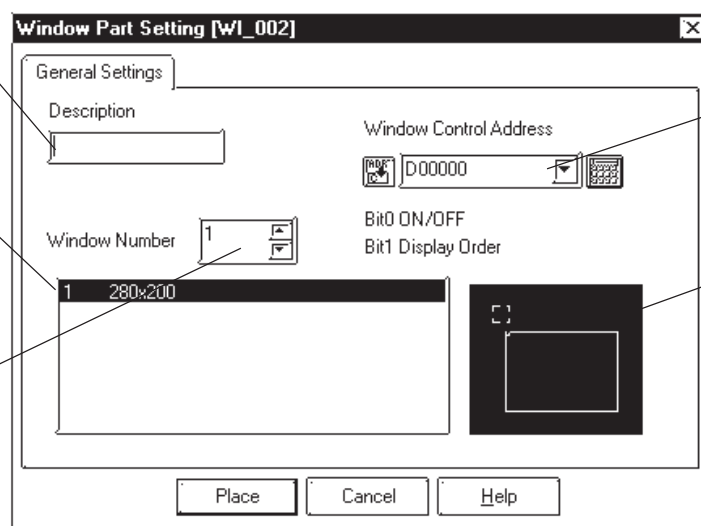

Specify the Window Control Address.

Preview the window associated with the selected Window Number in this area.

**◆ Window Control Address**

Enter the address to control the Hide/Show status of the windows.

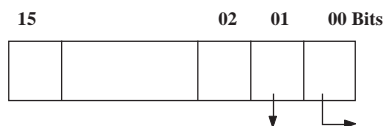

Show [0]: Hide the window

Changing the order of window layer [1]: Show the window

[0]: Touching the window will change the order of the layer.



[1]: Touching the window will NOT change the order of the layer.

**▼ Reference** 3.7.1 Overview of Window Display, 3.7.2 Window Registration on the U Screen

■ **Placing Window Parts**

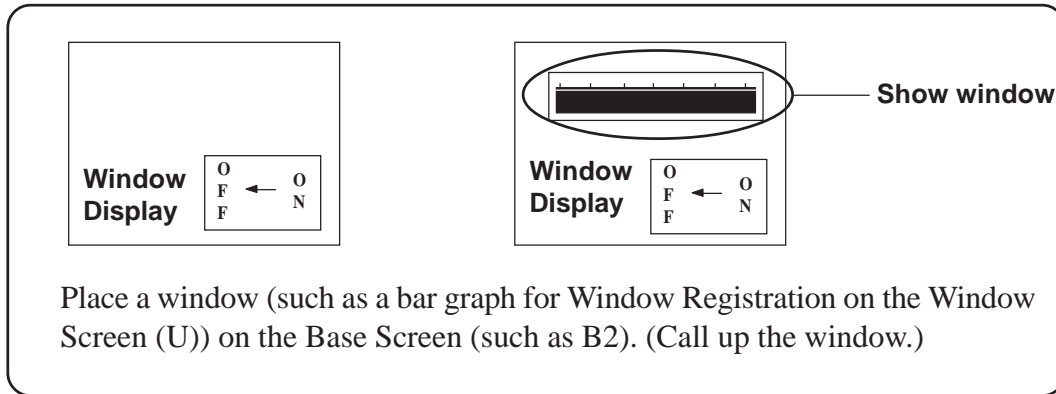
Procedure for placing Window Parts will be shown below.

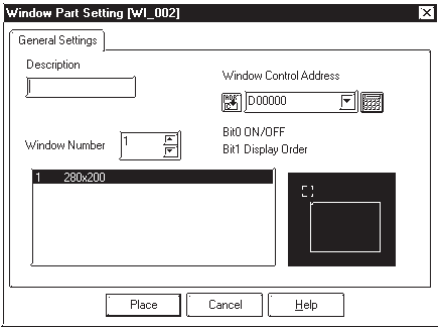

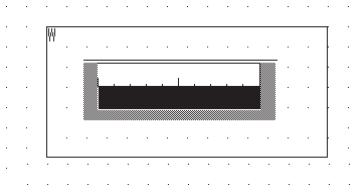
PROCEDURE	REMARKS
<p>(1) Select [Window Parts] from the [Parts] menu or click the  icon.</p> <p>(2) Select the window to be displayed on the Base Screen (B) from the "Window Number" field. Specify the Window Control Address as well.</p>  <p>(3) Click the  button after setting all attributes. The border of the window area is displayed on the drawing area.</p> <p>(4) Click on the point where the Window Part is to be placed.</p> 	<p><b>Reference</b> For Window Registration of parts on the Window Screen (U), refer to 3.7.2 <i>Window Registration on the U Screen</i>.</p> <p>When the specified area is overlapped by objects on the Base Screen, the object will be hidden while the window is displayed.</p>



## 2.2 Drawing

Straight lines, rectangles, and oval objects can be drawn, using drawing tools.

An object's attributes such as line types and colors are designated in its dialog box. After designating the object's attributes, move the cursor and start to draw the object directly in the drawing area.

**Note:** These objects can also be drawn via the Keypad and Trend Graph screens.

Usage Pattern			
<b>[Draw]</b>	→	Select a drawing command	→
	or		→
		Set any attributes	→
			Draw the object
Select a desired drawing icon from the Draw Tool Bar.			

### ■ Drawing Tools

Icons contained in the Draw Tool Bar and their corresponding drawing objects are as follows:

Icon	Object Types	Icon	Object Types
	Dot		Filled Polygon
	Line/Poly-line		Scale
	Square/Rectangle		Text
	Circle/Oval		Load Screen
	Arc/Pie		Load Mark
	Fill		

### ■ Selecting Line Types

10 selections are available for straight and poly-lines, and for graph divisions. 6 selections are available for rectangles, circles, arcs and pie sections.

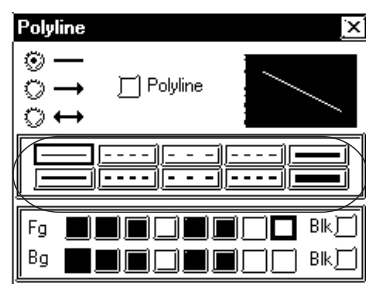

Select one of these patterns

## ■ Selecting Colors

For color and blink attribute settings, use the procedure same as for Parts.

▼ **Reference** ▲ 2.1 Parts ■ Part Attributes - Selecting Colors

## ■ Tiling Patterns

Nine different tiling patterns are available. These patterns can be selected for squares, circles, filled squares and polygonal objects. When combining foreground (Fg) and background (Bg) colors, a variety of filled patterns can be drawn.

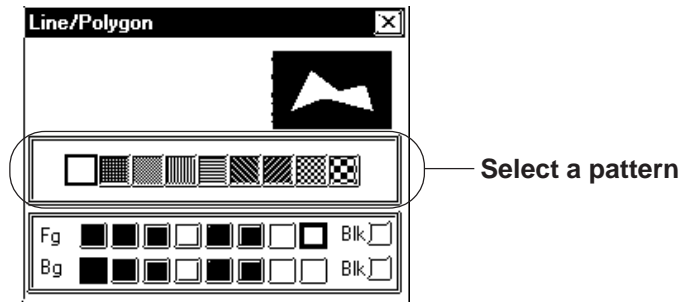

When a square or circle is drawn, only the line type will be displayed initially. To display the pattern selections, check the Fill check box. (check mark will appear)

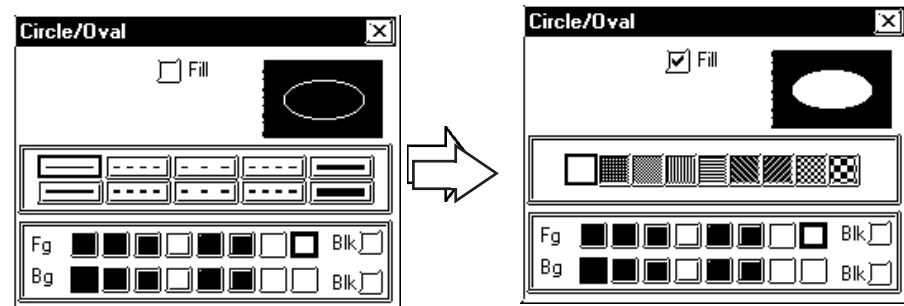



**2.2.1** Dot

Dots can be drawn in 1, 2, 3, and 5 dot units. To draw a dot, simply click on the desired point.

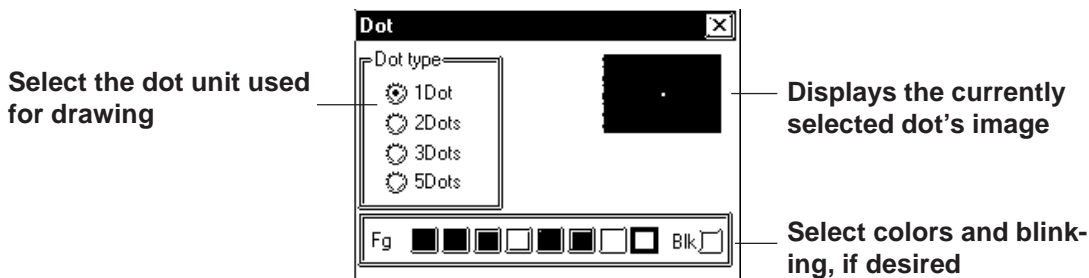
**■ Dot Attributes**

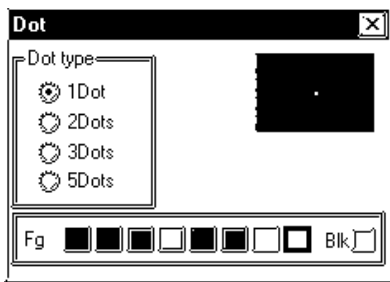
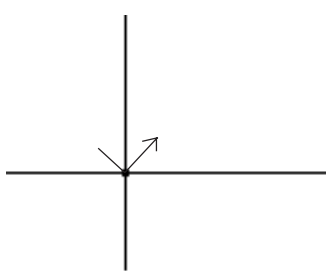

**■ Creating a Dot**

PROCEDURE	REMARKS
<p>(1) Select the [Draw] menu - [Dot] command, or click on the  icon.</p> <p>(2) Set the attributes of a dot to be drawn. Select a dot type and colors, if desired.</p>  <p>(3) Move the cursor to the drawing area. A dot will be drawn at the point clicked on.</p> 	<p>If an arrow (<math>\rightarrow</math>) is selected, the line's end point will become an arrow.</p> <p>When using the keyboard to draw a dot, move the cursor to the desired point and press the  key.</p> <p>To cancel/delete the dot, click on the  icon.</p> <p>Double-clicking on any object drawn on the screen automatically calls up that object's Attribute Settings dialog box.</p> <p><b>Reference</b> <a href="#">2.4.14 Changing Attributes</a></p>

**2.2.2 Line/Poly-line**

In order to draw a line, simply click to designate the line's start and end points. A continuous straight line can also be drawn; holding down the key allows you to draw lines at precisely 0°, 45°, or 90° angles.

**Line/Polyline Attributes**

Selects a line type (with or without arrows)

Selects a line type

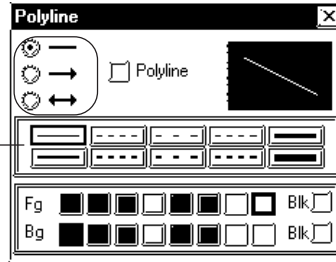

When drawing a polyline, check this box



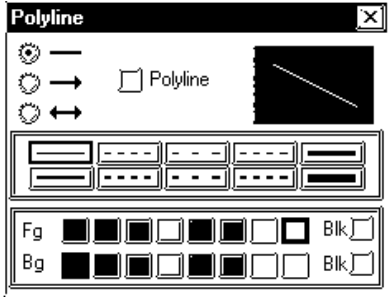
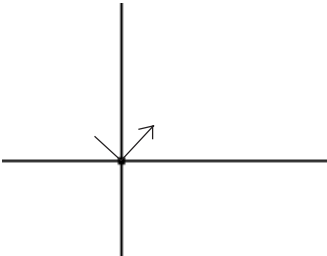

The currently selected line's image appears here

Select a color, and blinking, if desired

**Drawing a (Straight) Line**

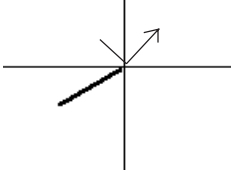
PROCEDURE	REMARKS
<p>(1) Select the [Draw] menu - [Line/Poly-line] command, or click on the  icon.</p> <p>(2) Set the attributes of a straight line to be drawn. If necessary, select the color and line type.</p>  <p>(3) Move the cursor to the drawing area, click on the line's starting point and drag the mouse to the end point.</p> 	<p>In step (4), while holding the <b>Ctrl</b> key down, a straight line at an angle of either 0, 45, or 90 degrees can also be drawn.</p> <p>When using the keyboard to draw a straight line, use the arrow keys to move the cursor to the start and end points and press the  key, to start and finish the line.</p>

PROCEDURE	REMARKS
<p>(4) Click again; a straight line is drawn (registered).</p> 	<p>To cancel the placement, click on the  icon.</p> <p>Double-clicking on any object drawn on the screen automatically calls up that object's attribute settings.</p> <p><b>Reference</b>  <b>2.4.14 Changing Attributes</b></p>

### ■ Drawing Polylines

When the Polyline check box is checked, Polylines can be drawn. Click on the starting point then drag the mouse, clicking the left mouse button at each point of the desired directional change of the line; and, click on the right mouse button at the end point of the line.



- When drawing, if the Keyboard's  key is pressed instead of clicking on the mouse right button, the start and end points of a polyline object will be automatically connected.
- You can draw a line that looks hand-drawn by holding down the mouse's left button when drawing a polyline.

**2.2.3 Square/Rectangle**

To draw a square, click on and designate the diagonal two points.

To draw a regular square, perform this operation while holding down the **Ctrl** key. By selecting a pattern before drawing, a filled square also can be drawn. Both normal (non-filled) and filled squares can be beveled.

■ **Square Attributes**

Check this check box when drawing a filled Square/Rectangle

Selects the type of Square/Rectangle

Selects a line (border) type

Select a Color and blinking, if desired

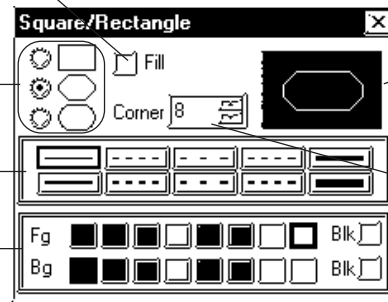

Displays the currently selected Square/Rectangle type

When selecting Corner, this number designates the number of dots used

<Filled Square/Rectangle Setting Screen>

Select one of the tiling patterns

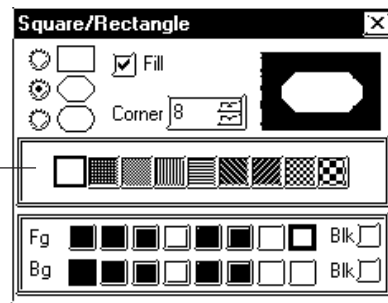

◆ **Square Shapes and Beveling types**

Square shapes and beveling types are as shown below.

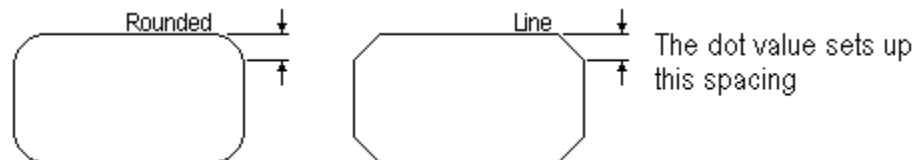

- Not beveled.
- All corners are beveled with straight lines.
- All corners are beveled with arcs.

When selecting Beveling, input a bevel dot number.

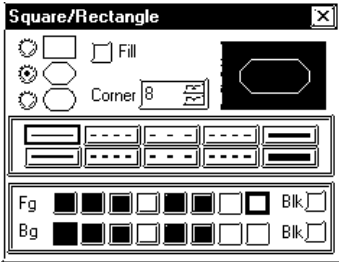
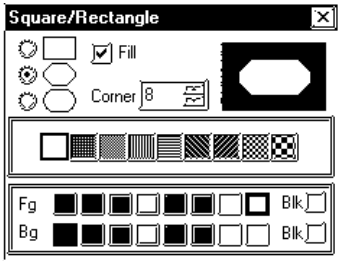
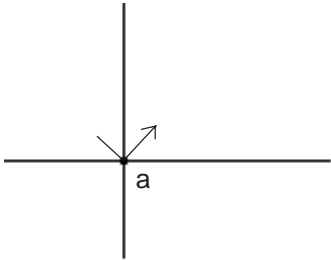
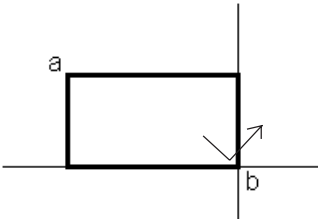

The dot value sets up this spacing

■ Drawing a Square/Rectangle

PROCEDURE	REMARKS
<p>(1) Select the [Draw] menu - [Square/Rectangle] command, or click on the  icon.</p> <p>(2) Set the attributes of the square/rectangle to be drawn. If desired, select the colors, line types, beveling type and dot. When drawing a filled square, check the Fill check box, instead of selecting line types.</p>  <p style="text-align: center;">↓ Select a pattern</p>  <p>(3) Move the cursor to the drawing area and click on the first of the diagonal's points, "a".</p>  <p>(4) Click on the diagonal's other point "b". The rectangle is automatically drawn (registered).</p> 	<p><b>Reference</b> 2.2.3 ■ <i>Square Attributes, Square Shapes and Beveling types</i></p> <p>In step (4), hold down the <b>Ctrl</b> key to draw a square.</p> <p>When using the keyboard to draw a square, use the arrow keys to move the cursor to the rectangle's two diagonal points and press the <b>↵</b> key to start and finish the rectangle.</p> <p>To cancel the placement, click on the  icon.</p> <p>Double-clicking on any object drawn on the screen automatically calls up that object's attribute settings.</p> <p><b>Reference</b> 2.4.14 <i>Changing Attributes</i></p>

**2.2.4 Circle/Oval**

To draw a circle or an oval, click on its center point and drag the mouse to the circumference point, and click again. Holding down the **[Ctrl]** key draws a perfect circle. To draw a filled circle or oval, select the desired pattern.

**Circle/Oval Attributes**

Check this check box, if a filled Circle/Oval is desired

Select a Line/Border type

Select a Fg and Bg color, and blinking, if desired

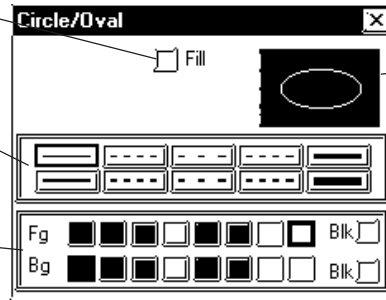

Displays the currently selected Circle/Oval image

<Filled Circle/Oval Setting Screen>

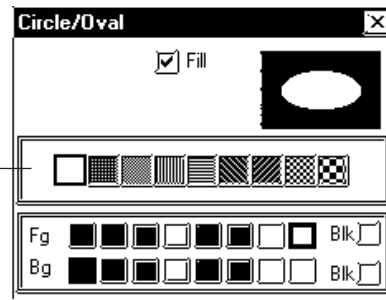

Select one of the Tiling patterns

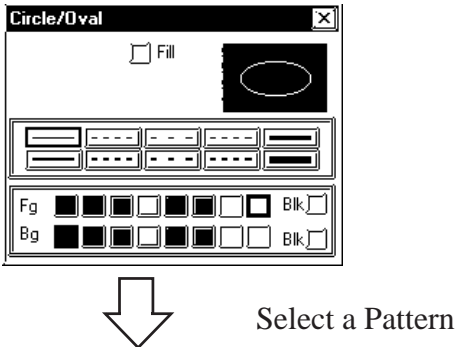

**Drawing a Circle/Oval**

PROCEDURE	REMARKS
<p>(1) Select the <b>[Draw]</b> menu - <b>[Circle/Oval]</b> command, or click on the  icon.</p> <p>(2) <b>Set attributes of an oval to be drawn.</b>                      Select colors and a line type, if desired. To draw a filled oval, check the <b>Fill</b> check box and select a pattern, instead of selecting a line type.</p> <div style="text-align: center;">  </div>	

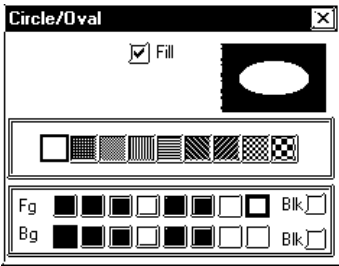
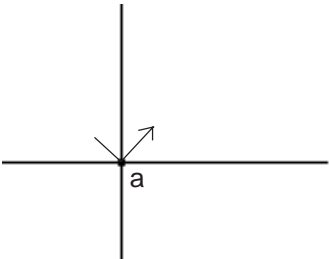
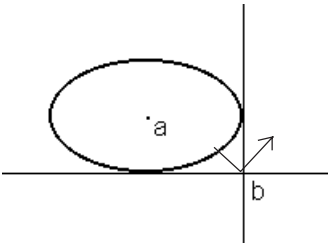

PROCEDURE	REMARKS
<div style="text-align: center;">  </div> <div style="text-align: center;">  </div> <p><b>(3) Move the cursor over the drawing area, and click on the center point, shown here by “a”.</b></p> <div style="text-align: center;">  </div> <p><b>(4) As the cursor is moved, the oval will expand or contract.</b> Click on the point shown by b. The drawn oval will be registered.</p> <div style="text-align: center;">  </div>	<p>In step (3), if the <b>[Shift]</b> key is held down, you can draw an oval which contacts a specified area (i.e. the side(s) of a square). This function is useful when drawing an inscribed circle and can also be used in step (4), together with the <b>[Ctrl]</b> key.</p> <p>To draw a regular circle, hold the <b>[Ctrl]</b> key down in step (4).</p> <p>When using the keyboard to draw an oval, use the arrow keys to move the cursor to the center point and then, to the point which defines its circumference (radius point), pressing the <b>[↵]</b> key each time.</p> <p>To cancel a drawing action, click on the  icon.</p> <p>Double-clicking on any object drawn on the screen automatically calls up that object’s attribute settings.</p> <p><b>▼ Reference ▲ 2.4.14 Changing Attributes</b></p>

**2.2.5 Arc/Pie**

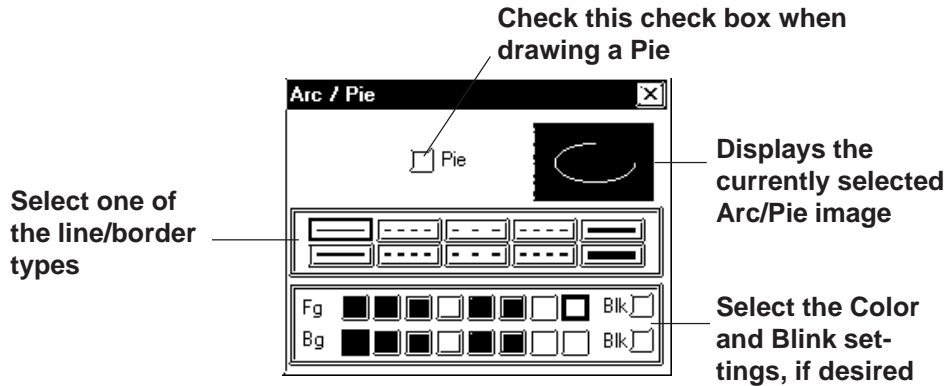

To draw an arc or pie, a portion of a circle must be selected. You will need to first draw a circle, and then, click on the arc's beginning and end points.

■ **Arc/Pie Attributes**

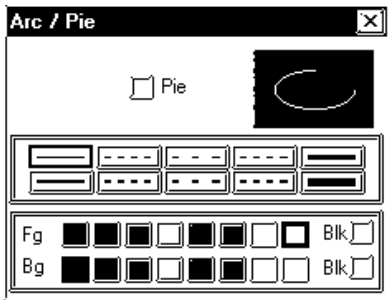
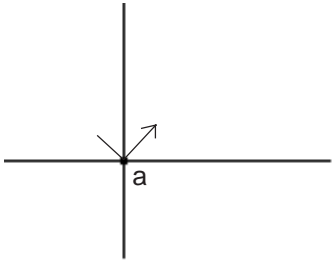

■ **Drawing an Arc**

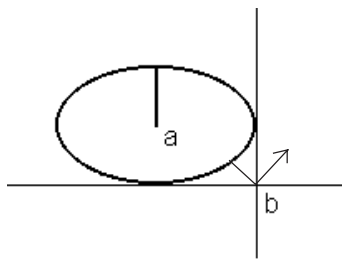
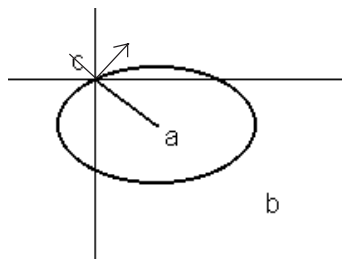
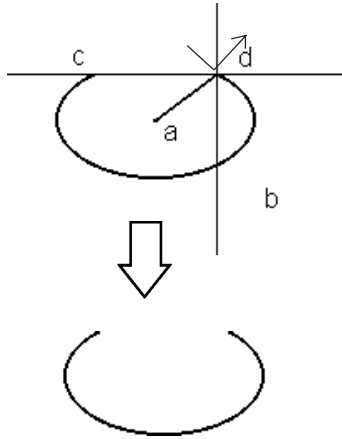
PROCEDURE	REMARKS
<p>(1) Select the [Draw] menu - [Arc/Pie] command, or click on the  icon.</p> <p>(2) Set the Arc's attributes. Select Colors and line type, if desired.</p>  <p>(3) Move the cursor to the drawing area and click on the oval's center point "a".</p> 	<p>In step (3), if the <b>[Shift]</b> key is held down, you can draw an oval which contacts a specified area (i.e. the side(s) of a square). This function is useful when drawing an inscribed circle and can also be used in step (4), together with the <b>[Ctrl]</b> key.</p>

PROCEDURE	REMARKS
<p><b>(4)Click on the oval’s radius point “b”.</b> An oval will appear and the arc’s base line will be displayed.</p> 	<p>In step (4), holding down the <b>Ctrl</b> key draws a circular arc.</p>
<p><b>(5)Click on the arc’s start point “c” or on its elongation.</b></p> 	<p>When using the keyboard to draw an arc, use the arrow keys to move the cursor first, to its center point, then, to another point on its circumference (radius point), and then, to its start and end points. Press the <b>Enter</b> key after specifying each of these points.</p>
<p><b>(6)Click on the arc’s end point “d”.</b> The arc will be drawn (registered).</p> 	<p>To cancel the drawing action, click on the  icon.</p> <p>Double-clicking on any object drawn on the screen automatically calls up that object’s attribute settings.</p> <p><b>Reference</b> 2.4.14 <i>Changing Attributes</i></p>

**■ Drawing a Pie (Sector)**

Follow the same steps used for the drawing of Arcs.

When using the same procedure to draw an Arc:

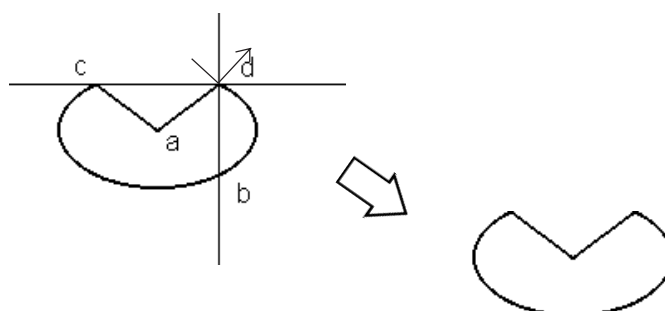

## 2.2.6 Fill

To use the Fill command, simply left-click your cursor on top of an object's enclosed area. The selected Fill pattern will then spread outward until it reaches a boundary. A boundary can be any line or Fill that is the same color as that chosen for the Fill's foreground, background, or border.



### <Cautions when Filling an Object>

- **Be sure that the area to be filled is completely enclosed with solid lines. Dotted lines can not be used as an enclosure.**
- **A space of only one dot on the border of an enclosed area is enough to allow Fill to leak into other areas of the screen. Be especially careful when drawing polygon vertexes and filling an object while the display is set to 50%.**
- **DO NOT attempt to fill objects that have been designated as blinking.**
- **When filling an image that uses an arc, Fill may leak when that image is actually displayed on the GP panel display. To prevent this, use a line to connect any gaps in the image.**

### ■ Fill Attributes

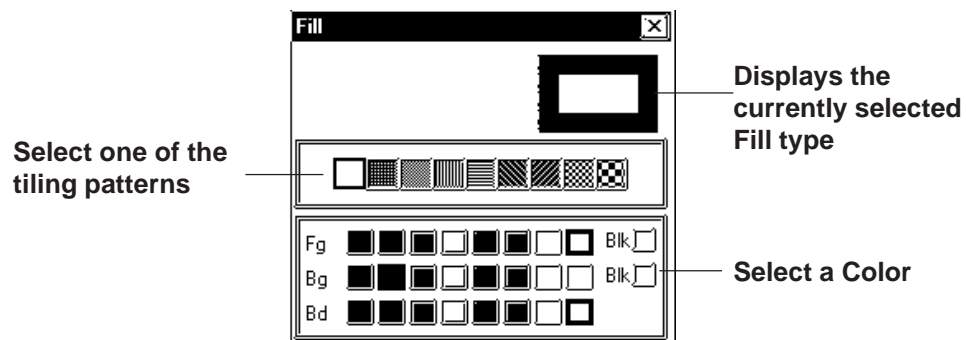





- To select the background color for all the screens used, use the [Option] menu's [Screen Settings] command.

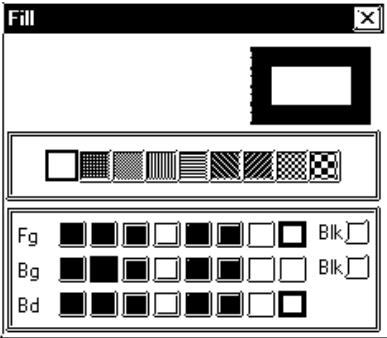
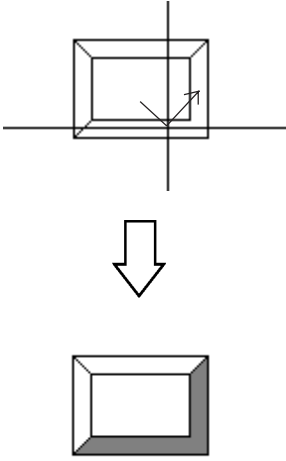
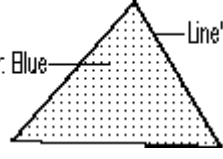

#### ▼ Reference ▲ 2.10.2 ■ Setting Screen Property - [Color]

- To cancel the application of a Fill due to a mistake, such as having designated the wrong Fill point, press the Esc key.

■ Filling an Object

PROCEDURE	REMARKS
<p>(1) Select the [Draw] menu - [Fill] command, or click on the  icon.</p> <p>(2) Set the attributes. Select Colors and Tiling Patterns, if desired.</p>  <p>(3) Move the cursor to the drawing area and click on the area to be filled. The designated area will be filled in.</p> 	<p>Fill spreads outward from the selected point until it reaches a border with one of the colors (Fg, Bg, Bd) selected in step (2).</p> <p>Select the same color for the Bd (border) Color and boundary Fg (foreground) Color.</p> <p>E.g. </p> <p>Left-clicking on a line will not cause it to be filled. Be sure to only click in an area enclosed by lines.</p> <p>When drawing via the PC's keyboard, press the  button to indicate a fill point. Fills and fill points can be specified to either display or not display via the drawing board.</p> <p><b>Reference</b> 2.10.2 <i>Screen Property Settings</i></p> <p>To cancel Fill due to a mistake, such as designating a wrong Fill point, press the  key.</p> <p>To cancel the filling, click on the  icon.</p> <p>Double-clicking on a filling point of any filled object drawn on the screen automatically calls up that filled object's attribute settings.</p> <p><b>Reference</b> 2.4.14 <i>Changing Attributes</i></p>

**2.2.7 Line / Polygon**

To draw a Polygon, either left-click or press the  key to indicate the Polygon's vertices. To complete the Polygon, either right-click or press the  to automatically connect the beginning and end points.

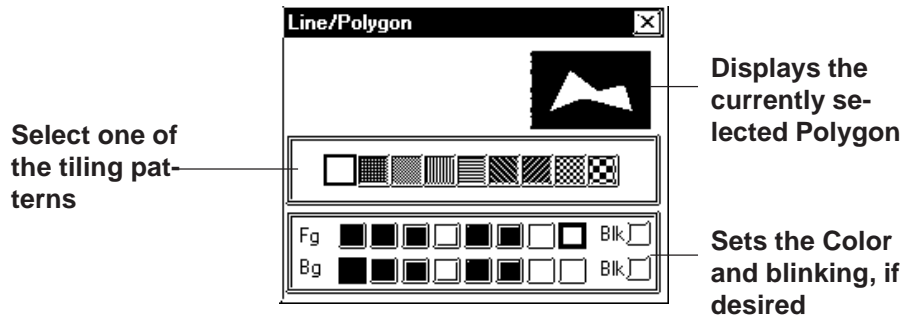

Holding down the  key while drawing a Polygon will snap the polygon's segments to 45 degree angles.

**■ Polygon Attributes**

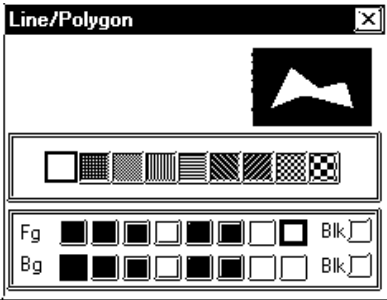
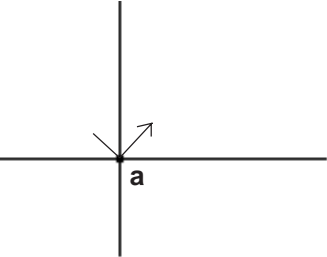

**■ Drawing a Polygon**

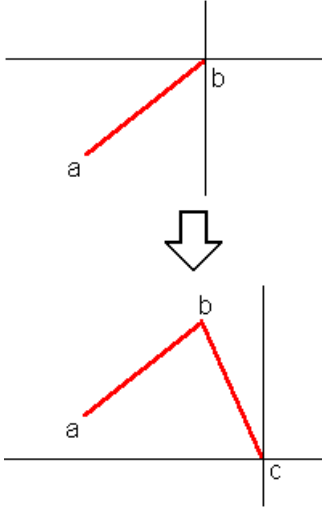
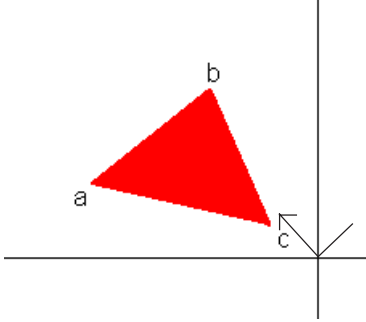
PROCEDURE	REMARKS
<p>(1) Select the [Draw] menu - [Filled Polygon] command, or click on the  icon.</p> <p>(2) Set attributes of a polygon to be drawn. Select Colors and Tiling Pattern, if desired.</p>  <p>(3) Move the cursor to the drawing area and click on the start point "a".</p> 	

PROCEDURE	REMARKS
<p>(4) <b>Left-click to designate the positions of the Polygon's vertices.</b> Repeat this for as many vertices as needed. Here, points b and c are also shown.</p> 	<p>Up to 100 corners (faces) can be created.</p> <p>In step (4), holding the <b>Ctrl</b> key causes lines to be drawn at exactly 0, 45, or 90 degree angles.</p>
<p>(5) <b>After defining the final vertex, c, right-click or press <b>C</b> to complete and fill the Polygon.</b> Points a and c are joined and the object is filled.</p> 	<p>To cancel the drawing, click on the  icon.</p> <p>Double-clicking on any object drawn on the screen automatically calls up that object's attribute settings.</p> <p><b>Reference</b> 2.4.14 <i>Changing Attributes</i></p>



• **About Filling a Polygon**

When a polygon's segments overlap, the filling alternates, so that areas next to each other do not display the same pattern. As a result, areas without any fill (white) may develop inside the polygon. If fill is desired in these areas as well, click on the  icon.

E.g.



**2.2.8 Scale**

To draw or create a Scale, input the number of divisions desired and then left-click the mouse's cursor to designate the scale's beginning and end points. Scales can be either horizontal or vertical, linear (straight line) or curved (semi-circle).

■ **Scale Attributes**



Annotations for the Scale dialog box:

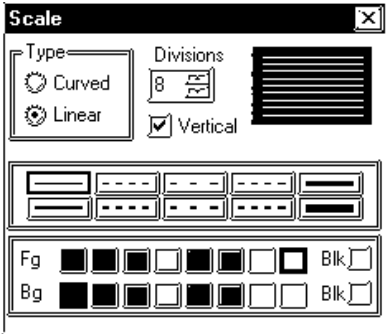

- Enter the number of divisions desired (points to the Divisions input field)
- Select the Scale's type (points to the Type radio buttons)
- Select the line type (points to the line style icons)
- Select the Color and blinking, if desired (points to the Fg and Bg color swatches)
- Displays the currently selected object's image (points to the scale preview)
- (Only with straight line Scales) Changes the scale's orientation to vertical (default is horizontal) (points to the Vertical checkbox)

■ **Drawing a Scale**

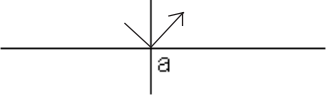
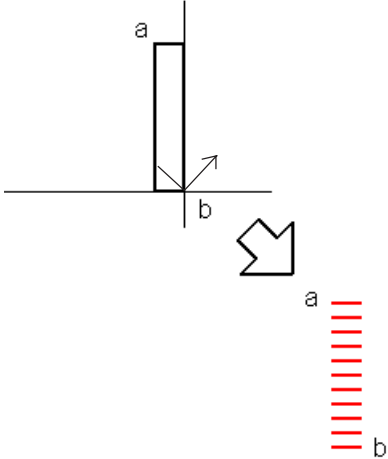
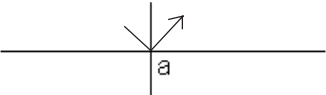
PROCEDURE	REMARKS
<p>(1) Select the [Draw] menu - [Scale] command, or click on the  icon.</p> <p>(2) <b>Set the attributes of the divisions to be marked.</b>                      Select the Scale's colors, line type, and Scale type, and input the number of scale divisions. If "Linear" is selected as the type, select the orientation direction by clicking on the Vertical check box. (Unchecked means Horizontal)</p> 	<p>&lt;Number of Divisions&gt;</p> <p>When the number of the divisions is specified as 8, a total of 9 division lines will be displayed.                      (i.e. the number entered +1)</p>

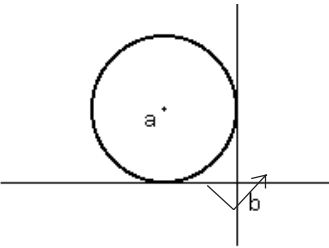
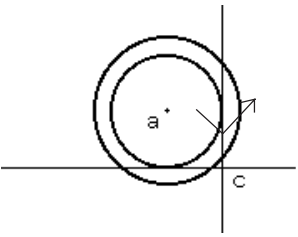
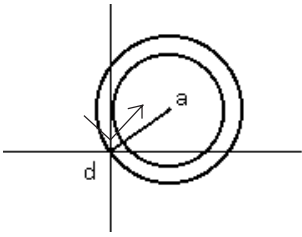
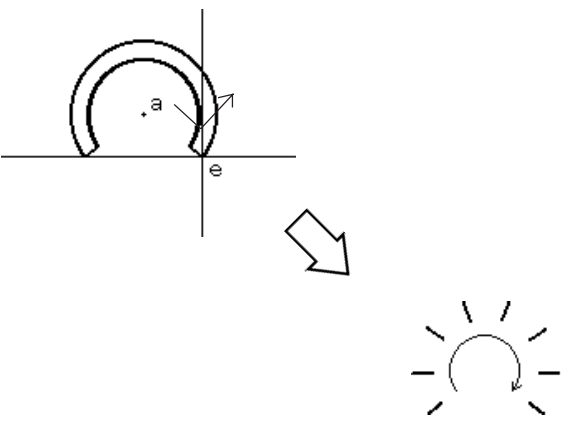

PROCEDURE	REMARKS
<p>The following explanation is divided into two parts; first, when creating a linear type scale, and second, when creating a curved type scale.</p> <p><b>[Creating a Linear type scale- (Vertical, with 8 divisions)]</b> Specify the area of division lines by a rectangle.</p> <p><b>(3)Use the mouse’s cursor to create a rectangle in the drawing area, i.e. left-click to indicate the linear scale’s start point, a.</b></p>  <p><b>(4)Complete the rectangle by left-clicking on the Scale’s end point, b.</b> The rectangle shape will disappear, and be replaced by division lines.</p>  <p><b>[Creating a Curved type scale- (8 divisions)]</b> Specify the area of division lines, using double circles.</p> <p><b>(3)Use the mouse’s cursor to create a circle on the drawing area, i.e. left-click to indicate the curved scale’s start point, a.</b></p> 	<p>Holding down the <b>[Ctrl]</b> key while performing step (4) will draw a perfect square.</p> <p>When using the keyboard to perform drawing, press the <b>[↵]</b> key to designate the start and finish points.</p> <p>To cancel the drawing, click on the  icon.</p>

PROCEDURE	REMARKS
<p>(4) Click on the radius point “b”, which is of a scale’s outer circle.</p> 	
<p>(5) Draw another circle inside the circle drawn in step (4) to decide the width of the scale. Click on this inner circle’s radius point “c”.</p> 	
<p>(6) Rotate the displayed segment and click on the scale start point “d” or on its elongation.</p> 	
<p>(7) Then, rotate the segment again until you reach the desired end point e, and click to designate the end of the scale’s divisions.</p> <p>Division lines appear inside the area surrounded with the double circles and the two segments. They will be drawn clockwise from the start point to the end point.</p> 	<p>When using the keyboard to draw divisions, press the  key after moving the cursor to the division circle’s center point, to the other point on its circumference (radius point), and then to the divisions’ start and end points.</p> <p>To cancel the drawing, click on the  icon.</p> <p>Double-clicking on any object drawn on the screen automatically calls up that object’s attribute settings.</p> <p><b>Reference</b> 2.4.14 <i>Changing Attributes</i></p>

**2.2.9 Text**

From the keyboard enter the text and then place it on the screen. This software has two methods of placing text on the screen. The first method defines the placement point, and the second defines the area where the text will be centered.

**■ Text Attributes**

Enter the text used as direct text.

Select the style of the text. (This feature is not available with Image Font.)

Specify the character size.

Select the type of text.

Select the desired font when using Image Font for Direct Text.

Displays a sample of the current text's attributes.

Select the text's display direction. (This feature is not available with Image Font.)

Select the Fg and Bg colors, and blinking.

When selected/enabled, the string's Bg (background) color becomes transparent.

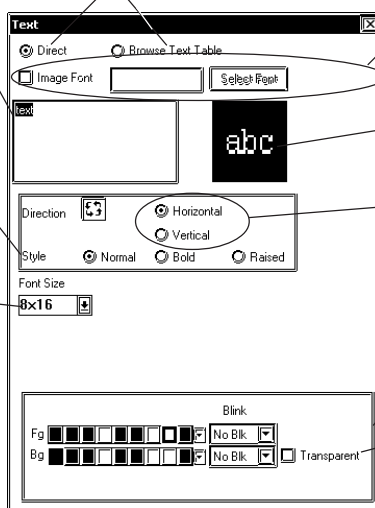

**◆ Direct Text**

The text entered in the text entry field is placed directly as a fixed text string. A maximum of 100 characters can be entered per line, and 100 lines per screen.

**◆ Browse Text Table**

Select and add the Text registered in the Text Table Editor.

**▼ Reference 4.6.3 ■ Selecting the index character string ◆ Entering the index character string**

**◆ Image Font**

Text using Windows fonts is displayed in bitmap format. This feature is enabled only when "Direct Text" mode is selected.



**Note:** Image Font is supported by the GP-2000 series only.

Click the [Select Font] button and specify the Font, Style and Size settings.

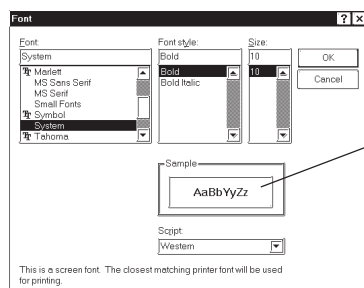

Displays a sample of the current text's attributes



- When Image Font is selected, the [Style] and "Vertical" text ("Vertical" under the "Direction" setting) cannot be specified.
- Image Font increases the size of the Project file. We recommend that the "Compress" setting be enabled.
- The maximum capacity of one text string is 50KB when Image Font is used.

Capacity of text with Image Font (Bytes)	=	(Number of dots for text width/8)	X	Number of dots for text height
--	---	-----------------------------------	---	--------------------------------

◆ **Compress**

This feature is enabled only when the Image Font option is selected. The Image Font is compressed to one-half its original size. (The compressed size may vary depending on the text.)

However, compression is not executed when the compressed character size becomes larger than the original size. The "Compress" setting is cancelled after the setting is confirmed by pressing the [OK] button.

◆ **Character Size**

Clicking on the font size display area, displays the current character size (used after text is placed on the drawing area). Move the cursor to where the X and Y axis lines cross, and drag the cursor. As the axis lines move, the character size will change. Click on the text block again, or press the key to register (enter) the change.

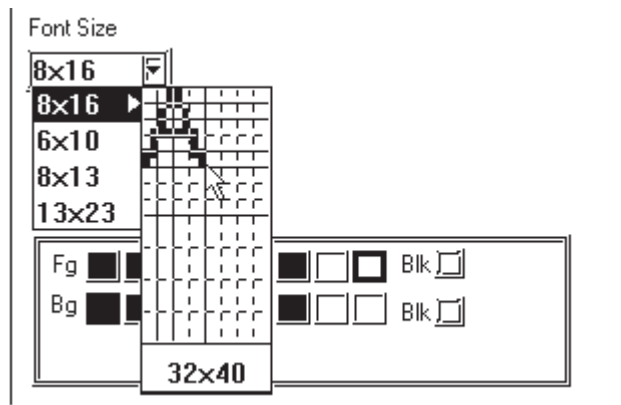

- Half-2 Byte Character (Only Chinese, Taiwanese and Korean OS - not available with GP-270 Series units.) can be used with Text strings, Bit Switches, Word Switches, Function Switches, Toggle Switches, 4-State Switches, Lamps and Message Displays.

		Half			Full	
<b>Character Size</b>	1 x 1	8 x 8	16 x 16	8 x 16	16 x 8	16 x 16
	2 x 2	16 x 16	32 x 32	16 x 32	32 x 16	32 x 32
	4 x 2	32 x 32	64 x 64	32 x 64	64 x 32	64 x 64

- Be aware that using Half-2 Byte Character feature may cause certain characters to change to garbage-characters that cannot be used.



- The Text Size can be selected as a multiple of any whole number from 1 through 8 with the GP2000 series and as either 1, 2, 4 or 8 with other models.
- Specify the point size when the Image Font option is selected. You can also specify the point size by clicking the [Select Font] button and selecting the font size in the [Size] field.
- When the text is zoomed in or zoomed out while the **Ctrl** key is pressed under Image Font mode, the text may exceed the frame of the system part.

The special extended font sizes are available only when entering single-byte numbers or symbols (6 x 10 dots/ 8 x 13 dots/ 13 x 23 dots).



- These extended fonts can also be used with Parts and Tags that allow you to modify the size of entered text characters. (not available with CSV and Logging data displays)
- Since extended font sizes are fixed, objects containing these characters cannot be enlarged or reduced while pressing down on the **Ctrl** key.
- 7-segment display of parts is not available with this feature.

#### ◆ Style

Characters can be either Normal, Bold, or Raised.

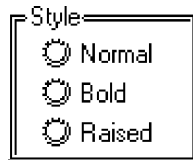

- When [Transparent] is selected or when text character backgrounds (Bg) is specified to Black + Blk (Blink), transparent mode is used, thereby displaying that area as transparent. For 256-color mode, select the last (255th) color, which is “Clr”. However, for the GP unit with three blink speeds, this mode can be specified only when the “Mid” speed is selected. If an object has been drawn underneath these characters, they (the characters) will appear transparent, showing the object behind. This function is useful when overlaying text on objects, i.e., over the face of Switches and Lamps.

**Reference** 2.1 Parts ■ Part Attributes-Selecting Colors

- You cannot specify the style when Image font is selected.

■ **Changing to a New Text Line and Line Settings**

When entering characters, simply press the  key to move to a new line. When there are 2 or more lines of text, icons will appear to allow adjustments in line spacing, and justification.

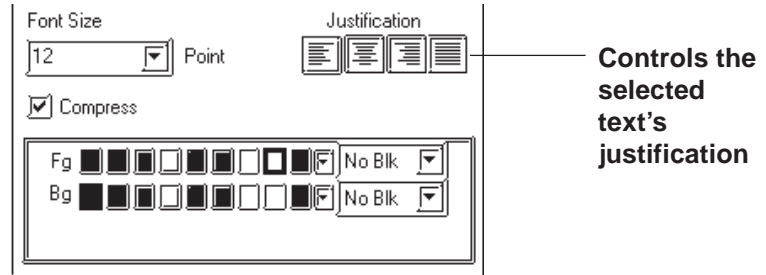



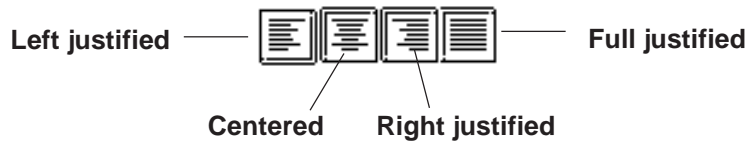

◆ **Justification**

Horizontal text's alignment can be changed to either Left, Center, Right or Full justified.

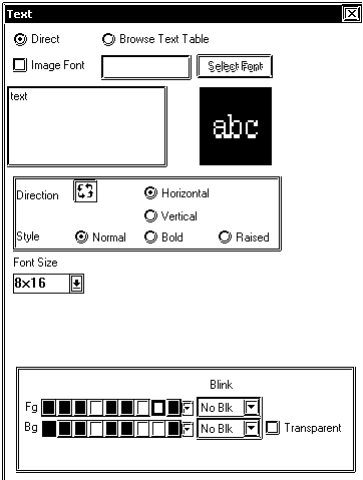

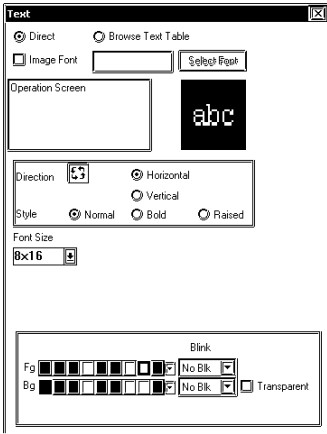
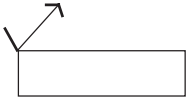
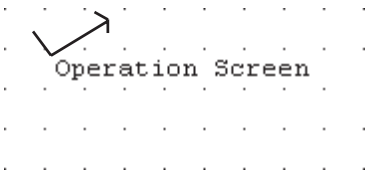
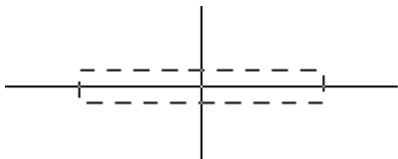
■ **Entering Text**

PROCEDURE	REMARKS
<p>(1) Select the [Draw] menu - [Text] command, or click on the  icon.</p> <p>(2) Set the attributes of the characters to be input. Select Colors and Character Size, if desired.</p> 	<p>When selecting [Browse Text Table]:</p> <p><b>Reference 4.6.3</b> ■ <i>Select the character string</i> ◆ <i>Entering the character string</i></p> <p>The attributes can also be entered and selected after entering text.</p> <p>When “Raised” is selected for Character Type, the border color (Bd) will become shadowed (i.e. 3-D).</p>

PROCEDURE	REMARKS
<p><b>(3)Click on the text field to input characters, via your PC’s keyboard, when selecting [Direct].</b> Simply clicking on the text field allows you to input characters there.</p>  <p>Hereafter, two text alignment cases will be explained, one not using and one using the Centering function:</p> <p><b>&lt;When Centering function is NOT used&gt;</b></p> <p><b>(4)Move the cursor to the drawing area and click on any desired point.</b> After clicking on a point in the drawing area, a text box the size of the selected character will appear on the screen. The top left corner of the text box is the base point used for positioning.</p>  <p><b>(5)Move the cursor to the desired position and left-click the mouse to place it on the screen.</b></p>  <p><b>&lt;When the Centering function IS used&gt;</b></p> <p><b>(4)Move the cursor over the desired placement area and, while holding down the [Shift] key, click on any desired point.</b> After clicking on a point in the drawing area, the text box will appear on the screen in dotted line.</p> 	 <p><b>Important</b></p> <p>·When the Image Font is selected, the "Direction" (Vertical/Horizontal) and "Style" text settings are disabled.</p> <p>When using your PC’s keyboard to enter text, press the  key to designate a position.</p> <p>To cancel the placement, click on the  icon.</p> <p>Double-clicking on any object drawn on the screen automatically calls up that object’s attribute settings.</p> <p><b>Reference</b>  <b>2.4.14 Changing Attributes</b></p>

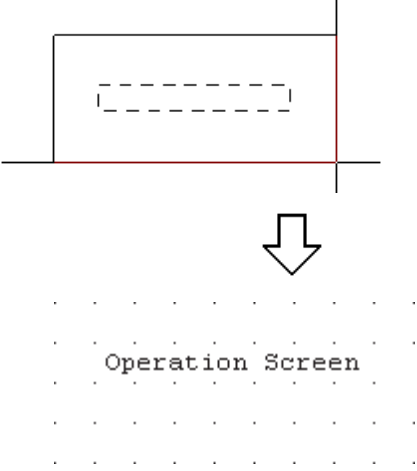
PROCEDURE	REMARKS
<p>(5) <b>Select a centering area that is the same size or larger than the previously selected text area.</b> The designated size's text box will appear in the center of the selected area.</p> 	<p>To cancel the designated area, click the right mouse button.</p>



- GP-PRO/PBIII for Windows uses the PC's font. As a result, the text that you see on the GP display and that shown on the PC may differ.
- In both GP-PROIII and GP-PRO/PBIII (DOS Ver.), when an object is overlaid on a text block, the text block will be displayed in the foreground. With GP-PRO/PBIII for Windows, however, the text block will be placed behind the object. When the GP-PROIII and GP-PRO/PBIII (DOS Ver.)'s data is used in the GP-PRO/PBIII for Windows, the text block will be displayed in the foreground.



### 2.2.10 Load Screens

Graphics created on screens in a project can be loaded and used repeatedly on others with GP-PRO/PB III for Windows. Thus, a single screen's contents can be used repeatedly elsewhere. The Load Screen function is also a good way to cut down on your screen's actual size, since you only need to call up items to your screen, not save them on it.

#### ■ Screens that can be loaded to other screens

Current Screen	Loadable Screens
<b>B (Base) screen</b>	B (Base) screen
	T (Trend graph) screen <sup>*1</sup>
	K (Keypad) screen <sup>*2</sup>
	I (Image) screen
	I (Image) screen-CF card
<b>T (Trend graph) screen</b>	B (Base) screen
	I (Image) screen
	I (Image) screen-CF card
<b>K (Keypad) screen</b>	B (Base) screen
	I (Image) screen
	I (Image) screen-CF card
<b>U (Window) screen</b>	B (Base) screen
	I (Image) screen
	I (Image) screen-CF card

*\*1 Up to 8 Trend Graph screens can be loaded onto each Base screen. However, only one trend graph with the Data Record Display function can be loaded.*

*\*2 Only one Keypad screen can be loaded onto each Base screen.*

The screen currently being edited cannot be loaded on to itself.



***If any portion of a Trend Graph screen extends over a Base screen's border, the Trend Graph screen will not display correctly on the GP screen.***



**Note:** If a portion of an Image screen extends over a Base screen's Y axis border, that portion will not be displayed on the GP screen. When the Image screen is placed over the Base screen laterally, however, any part that extends over the Base screen X axis border will be squeezed onto the GP screen.(i.e. not cut)

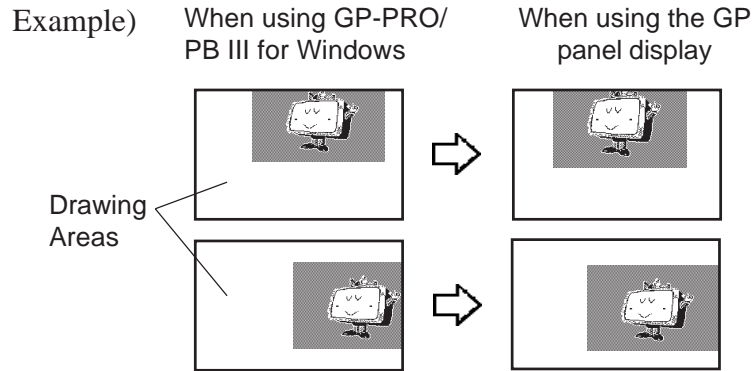

■ Nesting

Screens can be nested up to 10 times (11 layers). However, if your PC's system memory is low, a loaded screen/object may not be displayed. Later, however, when the data is transferred to the GP, the display will appear normally.

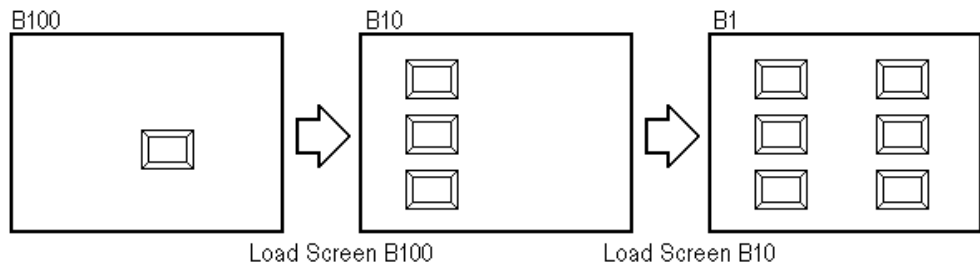

E.g.) Nesting Objects Twice (3 layers)



**Note:** The load screen nesting condition can be viewed via the load screen nesting display function.

**Reference** 2.10.9 *Display of Screen Level Change Structure*

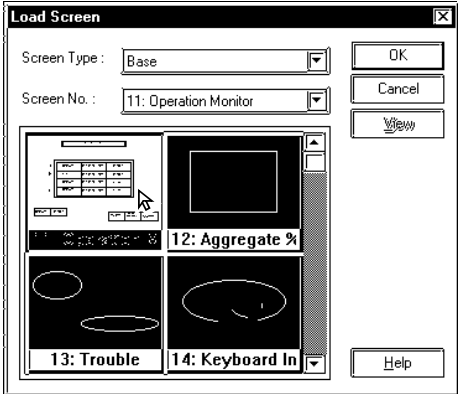
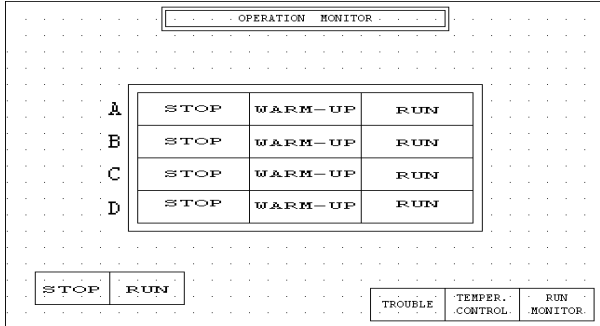
■ Loading a Screen

PROCEDURE	REMARKS
<p>(1) Select the [Draw] menu - [Load Screen] command, or click on the  icon.</p> <p>(2) Select a desired screen from the list or enter that screen's number directly on the [Screen No.] field via the keyboard, and then click on the <input type="button" value="OK"/> button. Then, the screen's outline and center point will appear in the drawing area, next to your cursor.</p>  <p>(3) Click on the point where the Screen's top left corner is to be placed. The image's center point is left top corner of its border, and for other objects, the screen center mark will be the placement point.</p> 	<p>Only screens in the currently used Project file can be loaded. Screens in other project files can not be loaded.</p> <p>The current (selected) Screen cannot be loaded on to itself.</p> <p>A loaded screen cannot be edited while it is being used on a different (i.e. loaded) screen. You will need to open the original screen to perform any editing.</p> <p>To cancel the loading, click on the  icon.</p>



**Note:** When calling up a filled object:

When the current screen's graphics overlap loaded filled (painted) graphics, depending on the color used, unfilled areas may be created. To correct this, add a fill to the current screen's unfilled area.

**Reference** 2.2.6 Fill

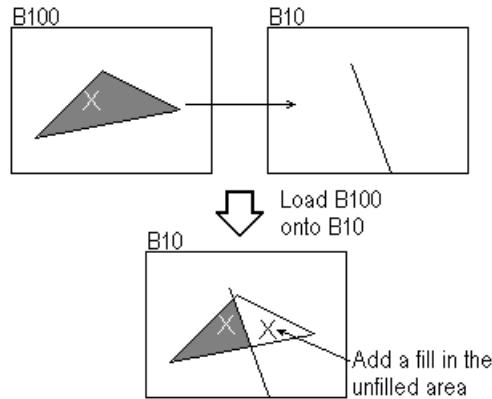



- **If a background color is selected for the screen used for screen call-up, the object placed on the screen will not be displayed on the GP.**
- **To call up the screen for which a background color has been selected, specify the center of the screen as the call-up position and then place the screen.**

**2.2.11 Load Mark**

Marks (dot images) created in a Mark screen can be loaded and used repeatedly on Base/Trend Graph/Keypad/Window screens.

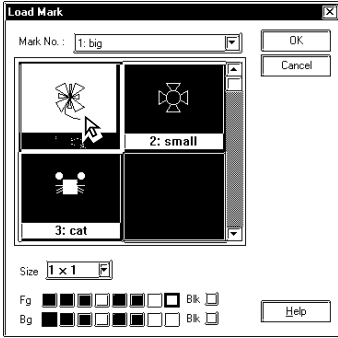
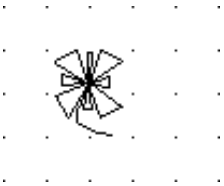
**■ Loading a Mark Screen**

PROCEDURE	REMARKS
<p>(1) Select the [Draw] menu - [Load Mark] command, or click on the  icon.</p> <p>(2) Select a desired Mark screen from the list or enter that screen's number directly on the [Screen No.] field via the keyboard, and then click on the <input type="button" value="OK"/> button.</p> <p>The Mark's outline will appear in the drawing area, next to your cursor.</p> <p>Designate its color and size before clicking on the [OK] button, if desired.</p>  <p>(3) Click on the point where the Mark's top left corner is to be placed.</p> <p>If desired, use the Mark's handles to alter its size.</p> 	<p>Only Mark screens in the current project can be loaded. Mark screens in other projects are not available.</p> <p>When the screen display size is 50%, the loaded Mark may not be displayed correctly on the GP-PRO/PB III for Windows software.</p> <p>To cancel the loading, click on the  icon.</p> <p><b>Reference</b> To change the Mark's size, refer to <b>2.4.3 Scaling Up/Down</b></p> <p>Double-clicking on any Mark loaded on the screen automatically calls up that Mark's attribute settings.</p> <p><b>Reference</b> <b>2.4.14 Changing Attributes</b></p>



**2.2.12 Convert (Import) Image**

This section describes how to convert image data (bitmap: BMP file and JPEG: JPEG file), created from other drawing software or imported from a scanner, for use on a GP Image (I) screen.

**Reference** For Image Conversion data, refer to *3.5 Creating an Image: the Image Screen*.

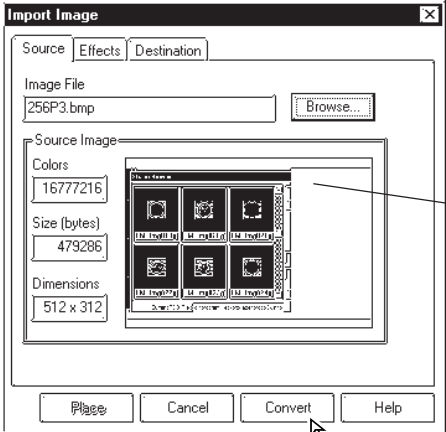
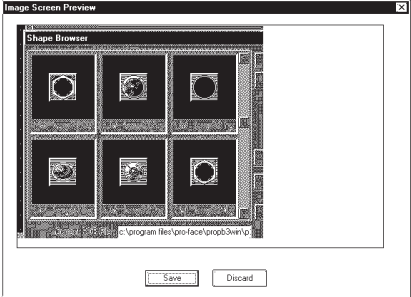
**■ Converting and Placing an Image**

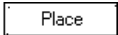
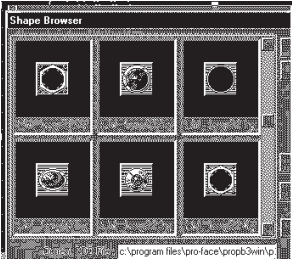
PROCEDURE	REMARKS
<p>(1) From the menu bar of the screen editor [Draw] menu's [Convert Image...] command.</p> <p>(2) Set all conversion settings and click on the <input type="button" value="Convert"/> button.</p>  <p>(3) Click on the <input type="button" value="Save"/> button. The data is then saved as an Image screen.</p> 	<p>Once an image has been converted, it can be placed on a screen using the Load Screen function.</p> <p><b>Reference</b> 2.2.10 Load Screens</p> <p><b>Reference</b> For each setting item, refer to <i>3.5 Creating an Image: the Image screen</i>.</p> <p>Before conversion, the image displayed in the Import Image dialog box is still compressed and may appear different from the actual display (after conversion).</p> <p>To cancel the conversion, simply click on the <input type="button" value="Cancel"/> button.</p>

PROCEDURE	REMARKS
<p><b>(4) Click on the  button.</b>                      The Image screen's border will appear on the current screen.</p>  <p><b>(5) Click on the point where the Image screen is to be placed.</b>                      The Image screen will appear on your screen.</p>	<p>To cancel the placement, click on the  icon.</p>



**Note:** If the Image screen(I) is placed outside the drawing area vertically, the portion of the image that does not fit in the drawing area will not be displayed on the GP screen. However, if the Image screen is placed outside the drawing area horizontally, the portion that does not fit will be squeezed so that it is displayed on the GP screen.

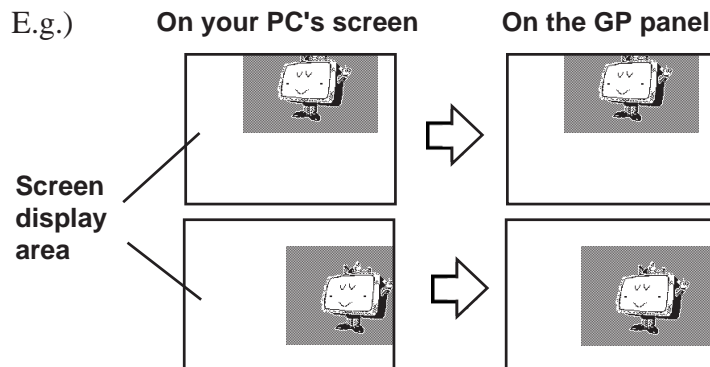

**■ Pasting images with other file formats**

The paste function can be used for images copied onto the Clipboard\*<sup>1</sup>. Executing the [Paste] command from screen editor while a copied image is in the clipboard will display the "Paste Image" dialog box on the screen. The "Source" tab will not be displayed on the screen. When images cannot be pasted with this procedure, convert the images into bitmap files or JPEG files with other image processing software before copying and pasting it to the screen editor.

\*1 The clipboard is a storage location where copied or cut data is temporarily stored. The data stored on the clipboard can be copied or moved by pasting it.

## 2.3 Tags

Tags are one of the GP-PRO/PBIII for Windows program’s many powerful features. When you create a Tag, you can transform a square on the screen into a switch, or create an animated display that changes according to data from the Host PLC. Tags are created and placed on the screen where you want a function to be; and, while most of the applications for Tags are on a Base screen, they can be used with Keypad screens, as well as a variety of other screens.

Here, topics such as Previously Created Tags, Changing of Tags, and Deleting Tags, are discussed.

For further details of tags, refer to the Tag Reference Manual.

### ■ Points to Consider when Creating Tags

When creating a Tag, please be aware of the following points:

- ◆ When creating a number of tags on identical screens, if one Tag’s position overlaps that of another Tag, the Tags will overlap when they are called up and may not be displayed correctly. Please be aware of this when loading (calling up) multiple Tags.
- ◆ Using the Copy or Paste functions to place Tags with the same name on similar screens can make identifying Tags difficult. It is suggested that you either change the Tag’s attributes (i.e. name) directly, or use the Tag Summary to change the name. When 2 or more K Tags have been used to operate a common Trigger Bit, it is especially important that the Tag names used are different.

**▼ Reference ▲ Tag Reference Manual 2.12 K-tag (Key Input)**

- ◆ The maximum number of tags designated on the same screen is as follows. This total includes tags on any screens that have been called up, or are included in a window that is used. The figure below, however, does not include any k tags or R tags.

GP Series	GP-470 GP-570 GP-675	GP-270 GP-370 GP-H70	GP-377 GP77R GP2000
Number of tags	256	128	384

Refer to the figure below for the enabled tags.

<Example: when using GP-470>

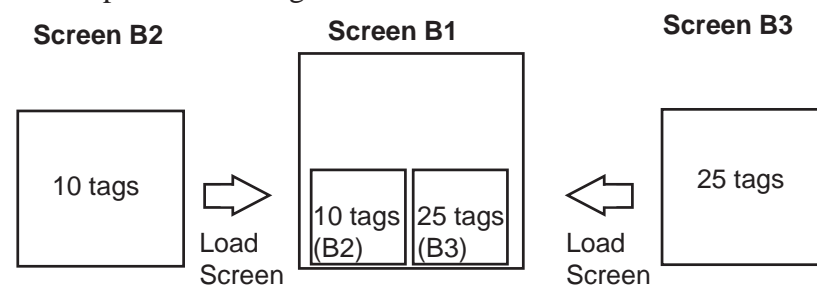

Combined number of Tags = 10(B2) + 25 (B3) + 30(B1) = **65 ≤ 256**

Number of tags can be viewed from the Screen Information in GP-PRO/PBIII.

**▼ Reference ▲ 4.5.2 Screen Information**



- ◆ Though all of a Tag's identifying marks, lines, etc. can be seen on the screen that it was created on, after that Tag's screen is called up to a Base screen, those Marks can no longer be seen and it can not be edited. In example 1 above, even though screen tags B2 and B3 are added to B1's total tag count, their identification data is not displayed on B1 (Drawing area, Tag List, etc.) and can not be edited from that screen. To edit these Marks, call up the Base screen on which each Tag was specified.
- ◆ The order in which each Tag is created is recorded, and when the total tag count for that screen exceeds 256 (Digital's GP-H70, GP-270 and GP-370 count up to 128 tags. GP-377, GP37W2, GP-377R, GP77R and GP2000 can use up to 384 tags.), those excess tags are ineffective. When the tags used on a screen have been called up from a window, those tags are added to the total, in the order that the window was called up. Thus, when calling up multiple windows for use on a screen, be sure that the total number of tags used in all the windows does not exceed the above limit, or certain tags will become invalid.
- ◆ Approximately 90 reserved tags are used for the Device Monitor function. When using Device Monitor together with regular screen tags, they must be added to the screen's total tag count. Thus, be sure that the tags used for the Device Monitor are included in your tag count calculation. If the total becomes greater than that screen's limit, the message "Total No. of Tags is over limit." will appear. Until the number of tags is reduced, there is a possibility that the Device Monitor function will not work correctly. If using the Device Monitor function will cause a screen's total tag count to exceed its limit, you should not use Device Monitor function on that screen.

**Reference**  *4.8 Device Monitor*

- ◆ The actual amount of space required (in bytes) for each tag will vary. When placing tags on a screen, please consider the number of tags that have already been created, the size of each tag, and the panel's tag limit. Information such as the current screen capacity and number of tags used can be viewed in the [Screen Information] dialog box.

**Reference**  *4.5.2 Screen Information*

For each tag size, refer to the following table.

## &lt;Tag Size List&gt;

Tag Name	Function	Tag Size (Byte)
<b>A</b>	Alarm Summary Text Display	56
<b>a</b>	Alarm Summary Display	34
<b>C</b>	Clock Display	28
<b>D</b>	Statistic Graph Display	48
<b>d</b>	Statistic Data Display	74
<b>E</b>	Numeric Data Display extended function	32 to 122
<b>F</b>	Free Library Display	42
<b>G</b>	Graph Display	40
<b>g</b>	Graph Display extended function	38 to 158
<b>H</b>	Drawing Object Display	42
<b>J</b>	Moving Mark Display	38
<b>K</b>	Key Input	46, 58
<b>k</b>	Keypad Setup	28
<b>L</b>	Library Display	34
<b>I</b>	Library State Display	40 to 102
<b>M</b>	Mark Display	34
<b>N</b>	Numeric Data Display	36
<b>n</b>	Alarm Boundary Display	30
<b>P</b>	Numeric Display in Predefined Format	118
<b>Q</b>	Alarm Summary Display extended function	46, 66, 98
<b>R</b>	Rail Settings	20
<b>S</b>	String Display	32
<b>T</b> (including Tih, Tiw)	Touch Panel Input	36
<b>t</b>	Selector Switch Input	56
<b>U</b>	Window Display	34
<b>V</b>	Video Window Display	30
<b>v</b>	Video Window Extended Features	42
<b>W</b>	Write to a Device	32
<b>X</b>	Text Data Display	40

Be aware of the following points:

- The total number of t-tags that can be used on the GP-470, 570, 571, 675 and 870 is 128; with the GP-270, 370, and H70, it is 64; with the GP-377, GP-37W2, GP77R and GP2000 series, it is 192.
- Only one (1) A, a, and C- tag can be used per screen.
- A total of 30 R tags are possible on one screen. The total number of points used for R-tag data can be up to 406 per screen. However, when calling up multiple screens, the total points allowable is 512.
- The number of windows that can be displayed on one screen at one time is up to 3, i.e. one global window and two local windows via the U-tag.
- Tih, and Tiw tags cannot be used on the GP-H70, GP-270, GP-370, GP-57J, GP-377, GP-37W2, GP-377R and GP2000 series units, since they do not have AUX I/F Touch Switch output (TSW0 to 7).

**2.3.1 Designating Tags**

The tag setting items will differ depending on each tag type. Here, the basic setting procedures are described.

After a Tag is selected, that tag's dialog box will appear. Here all the tag's attribute data, such as the setting address, are entered. After all of the Tag's attributes have been entered, click on the  button and designate the point or area on the screen where the Tag will function.

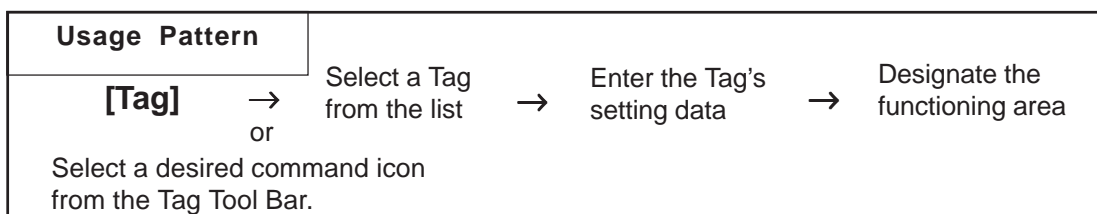

**■ Tag Settings**

An example of a Tag's dialog box is shown below.

In the [General Info] area, the Tag's name and description data are entered. Also, the Tag's general settings are displayed.

E.g.) L Tag

The actual setting items displayed will differ, depending on the tag.

**▼ Reference ▲** *Tag Reference Manual*

■ **Setting up Tags**

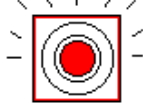
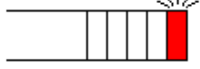

An example of an L tag's setting procedure is shown below.

GP-PRO/PBIII Tag Settings	PLC	GP Display
Tag Name	Lamp L1	 <p>the Lamp is on. (When M0016 is off, the Lamp is off)</p>
Display Mode		
Bit Address	M0016	
Designated Screen	Direct: 300 When M0016 is on...	
Erase Mode	Yes	

In order to show a Lamp's ON and OFF states on the screen, the above mentioned settings will be used to create a lamp and its ON image.

- (1) In preparation, draw a lamp on the screen where the Tag will be positioned.
- (2) Draw an image of the lamp's lighting area on screen B300 (This image will be loaded onto the screen's center point. Create the image based on this center mark)

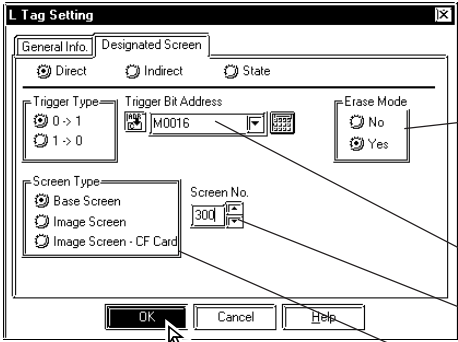
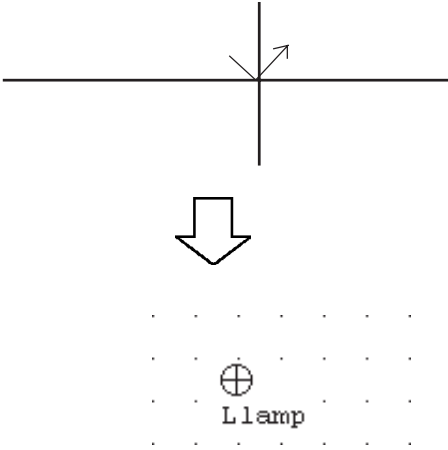
PROCEDURE	REMARKS
<p>(1) Select the [Tag] menu - [L-tag] command, or click on the  icon.</p> <p>(2) Enter the tag's name. If desired, enter a description.</p> <div style="display: flex; align-items: center;"> <div style="border: 1px solid black; padding: 5px; margin-right: 10px;"> <p><b>L Tag Setting</b></p> <p>General   Screen Access</p> <p>Tag Name: L lamp 1</p> <p>Description: set up now lamp</p> <hr/> <p>Word Address: ----</p> <p>Bit Address: X00000</p> <p>Trigger Mode: 0 -&gt; 1</p> <p>Screen Access: Direct</p> <p>Screen No.: Base : 1</p> <hr/> <p>Erase Mode: No</p> <p>OK Cancel Help</p> </div> <div> <p>Enter lamp 1</p> <p>Enter set up now lamp</p> </div> </div>	<p>A Tag name should be 5 characters or less.</p> <p><b>Reference</b> <i>Tag Reference Manual, 2.14 L-tag (Library Display)</i></p>

PROCEDURE	REMARKS
<p>(3) Enter the required data in the [Designated Screen] area and click on the  button to register it.</p>  <p>Click on <b>Yes</b></p> <p>Enter <b>M0016</b></p> <p>Enter <b>300</b></p> <p>Select <b>Screen Type</b></p> <p>(4) Click on the point where the tag is to be used. How this point is designated will differ depending on each Tag type.</p> 	<p>If your GP type is the GP77R or GP2000 series, [Image Screen - CF Card] can be selected in the [Screen Type] section.</p> <p>Use the pull down menu [Option]'s [Screen Property] command to change the Tag name, setting address, and Tag mark display state (i.e. displayed or not displayed). (However, these settings will not be displayed on the GP screen.)</p> <p><b>Reference</b> <a href="#">2.10.2 Screen Property Settings</a></p> <p>To cancel the placement, click on the  icon.</p> <p>Double-clicking on any Tab registered on the screen automatically calls up that Tag's attribute settings.</p> <p><b>Reference</b> <a href="#">2.4.14 Changing Attributes</a></p>





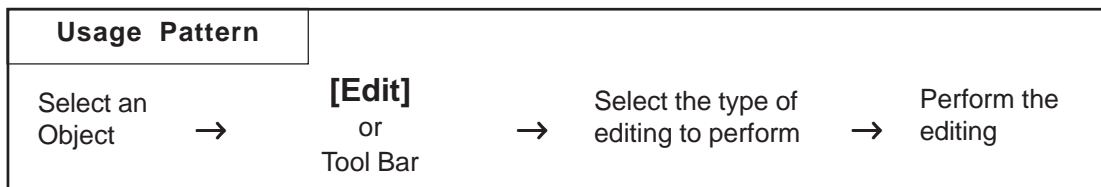











## 2.4 Object Editing

Parts, objects, text, and Tags previously placed or drawn (hereafter called “Objects”), can be edited using various functions, such as Copy and Delete. To edit an object, first, use the cursor to select the object, and then select the type of edit operation.



### ■ Types of Editing Functions

Icons contained in the Edit Tool Bar and their corresponding edit operation are as follows:

Icon	Edit Type	Icon	Edit Type
	Undo		Group
	Redo		Ungroup
	Cut		Bring to Front
	Copy		Send to Back
	Paste		Change Attribute
	Command Data Paste <sup>*1</sup>		Change Coordinates
	Duplicate		Vertex Editing
	Delete		Transferring Screen to Clipboard
	Align		Converting Screen to Bitmap File
	Rotate Left		Redraw Screen
	Rotate Right		Select All
	Mirror X-axis		Select
	Mirror Y-axis		

**Note:** Some of the editing tools listed above can be selected from the menu displayed on the screen by right-clicking the mouse.

*\*1 This function is enabled only when GP Type selection is a GLC series unit.*

**Reference** Pro-Control Editor Operation Manual

### 2.4.1 Selecting Objects

Two methods are available for selecting objects: 1) clicking on an object directly, or 2) dragging the mouse to enclose and select single or multiple objects.

Also, you can select individual objects that have other objects either on top of, or overlapping them.

When the tool bar's  icon is clicked on (active), an object can be selected. To activate this icon, click on it directly, or select the pull down [Edit] menu's [Select] command. Also, while drawing objects, right-clicking anywhere on a desired object allows you to select it.

Either a  or a  mark will be displayed on the sides of the selected object. These square marks are called "handles".

#### Handle Types

There are two types of handles, those that can be used to scale the object and those that can not. **Reference** Refer to 2.4.3 *Scaling Up/Down*

- : Can be used to scale the object
- : Cannot be used to scale

When an object has been selected, the Selection Tool box will automatically appear. When multiple objects are selected, all the selection Tool box's functions are available.

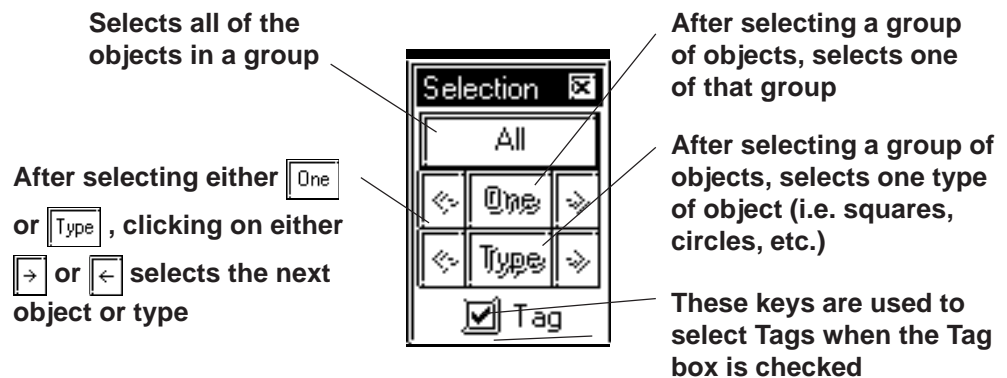

**Selects all of the objects in a group**

**After selecting either  One or  Type, clicking on either  or  selects the next object or type**

**After selecting a group of objects, selects one of that group**

**After selecting a group of objects, selects one type of object (i.e. squares, circles, etc.)**

**These keys are used to select Tags when the Tag box is checked**



**Note:** Objects may be selected using the Screen Data List, instead of selecting them on the screen.

#### **Reference** 2.10.4 Screen Data List

- When the tag check box for the selection tool box is marked with a check, tags can be selected even if the tag names and marks are hidden.

■ **How to Select a Single Object**

Here, the procedure for selecting an object is explained.

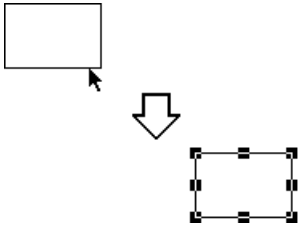
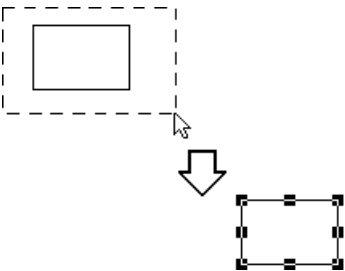
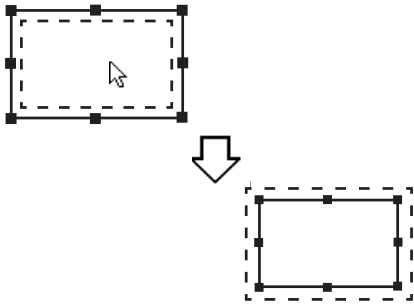
PROCEDURE	REMARKS
<p><b>[Selecting an Object Directly]</b></p> <p><b>(1) Move the cursor over the object, and left-click.</b>                      Handles display on the object to show that it is selected.</p> 	<p>To select a Tag, check the [Option] menu's [Screen Property] command's Tag Mark check box beforehand.</p> <p>When selecting grouped objects, click on any one of the objects in a group to select the group.</p>
<p><b>[Selecting an Object by Dragging]</b></p> <p><b>(1) Position the cursor near the object and hold the button down, then drag (this is called "Left-dragging") the mouse over the object. As you do so, a "box" formed by a dotted line will expand to enclose the object. When the entire object is enclosed within the "box", release the mouse button; handles display on the object to show that it has been selected. You must position the cursor relative to the object so that when you Left-drag over it, the entire object will be enclosed within the "box"; if it is not, then the object will not be selected. This method is most useful when selecting multiple objects, described below.</b></p> 	<p>A Part's Label can be selected independently from the Part.</p> <p>Click on a Part to display its handles and then on its Label to display the Label's handles. After selecting the Label, it can be moved or scaled independently from the Part.</p> <p>Numeric Display and text can also be selected using the above-mentioned steps.</p> <p>Left-dragging over only a part of the object will not select it. The entire object must be enclosed to select it.</p>
<p><b>[Selecting an Object from Overlapped Objects]</b></p> <p><b>(1) While holding down the [Ctrl] key, click on an Object to be selected.</b>                      That Object's handles will appear to reveal it has been selected.</p> 	<p>When you wish to select another object without de-selecting the previous one, hold down the [Shift] key while making the next selection. This can also be done continually to select multiple objects.</p>





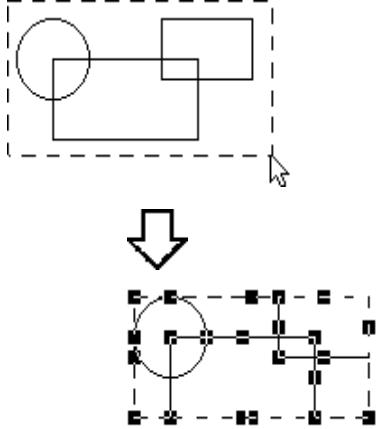
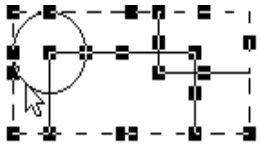

■ **How to Select Multiple Objects**

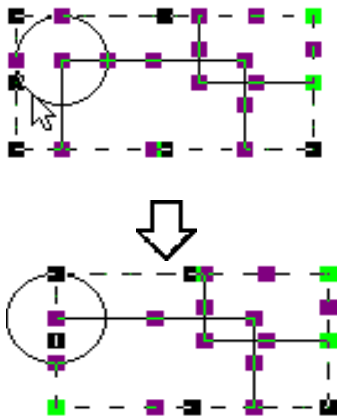
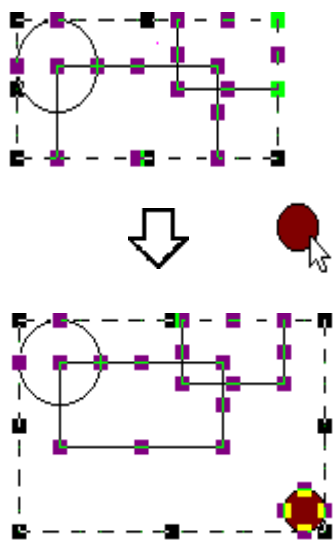
Use this operation to select multiple objects. All the objects in a designated area or on the entire screen can be selected. Also, if necessary, some of these objects can be de-selected.

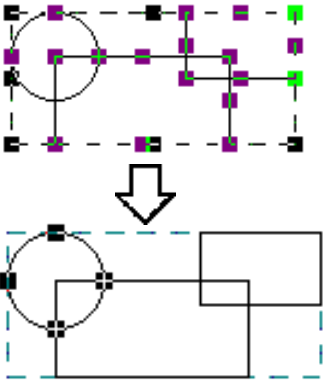
PROCEDURE	REMARKS
<p><b>[Selecting Multiple Objects by Dragging]</b></p> <p>(1) <b>Left-drag over objects as described in Selecting an Object by Dragging (see above). Be sure to enclose all of the objects to be selected completely; if part of an object is not enclosed within the “box”, it will not be included in the multiple selection. Handles will display on the objects that have been selected.</b></p>  <p><b>[Selecting All the Objects on a Screen]</b></p> <p>(1) <b>Select the pull down [Edit] menu’s [Select All Objects] command. All object handles will appear, to show that they have been selected.</b></p> 	<p>To select a Tag, check the [Option] menu’s [Screen Property] command’s Tag Mark check box beforehand.</p> <p>Left-dragging over only a part of an object will not select it. The entire object must be specified to make selection possible.</p> <p>When two or more objects are selected, the [Change Attributes] command cannot be used.</p> <p>The editing commands available depend on what objects have been selected.</p>

PROCEDURE	REMARKS
<p><b>[Excluding Objects From A Multiple Selection]</b></p> <p>(2)When multiple objects are selected, to de-select an object while preserving the selection of the other objects, first move the cursor over the object; then, while holding down the <b>Shift</b> key, left-click on the object. When the object's handles disappear, that object is no longer selected. Repeat this process as many times as desired.</p>  <p><b>[Adding Objects To A Multiple Selection]</b></p> <p>(2)When multiple objects are selected, to add an object, either left-click on the object or Left-drag over it, while holding down the <b>Shift</b> key. The imaginary “box” that encloses the multiple selection (represented by its’ own handles) will expand to include the added object , which now has handles Using this process, you can add as many objects to the multiple selection as you want.</p> 	

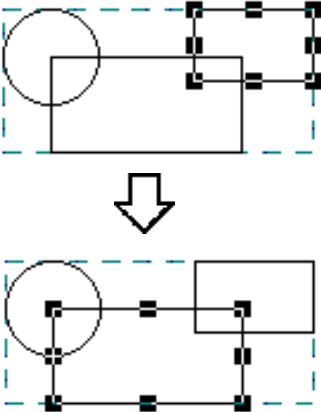
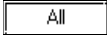

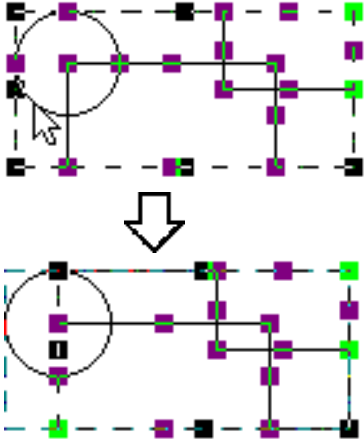
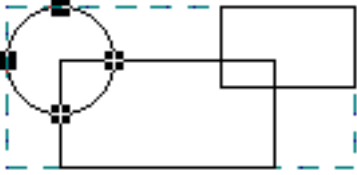



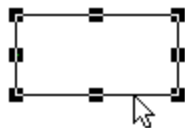

PROCEDURE	REMARKS
<p><b>[Selecting One Object in a Multiple Selection]</b></p> <p>(2) First, make a multiple selection; then, click on the Selection Tool box's  icon. All the objects in the multiple selection will become de-selected, except for one.</p>  <p>(3) Use the  and  icons to “scroll” through all the objects originally in the multiple selection; clicking on these arrow keys will change the selected item, one at a time. Clicking on the  icon will select the next object, and clicking on the  icon will select the previous object, in the order that they were drawn.</p> 	<p>If you wish to re-select all the objects originally in the multiple selection, click on the Selection Tool box's  button.</p> <p>To select an Object from overlapped Objects.</p> <p><b>▼ Reference ▲</b> ■ <i>How to Select a Single Object</i></p>

PROCEDURE	REMARKS
<p><b>[Selecting Objects by Type from a Multiple Selection]</b></p> <p>(2) <b>First, make a multiple selection; then, click on the Selection Tool box's <input type="checkbox"/> Type icon.</b></p> <p>Selection handles will appear for only one type of object (here, only square objects are selected), while an outline remains around them all. This will effectively de-select any objects that are not the currently selected type.</p>  <p>(3) <b>Use the <input type="checkbox"/> ← and <input type="checkbox"/> → icons to select a different object type.</b></p> <p>As you press either arrow key, the selected object type will change.</p> 	<p>Objects are classified as follows:</p> <ul style="list-style-type: none"> <li>Parts: by each type,</li> <li>Objects: by each type,</li> <li>Tags: All as one type,</li> <li>Loaded Screens and Marks: All as one type, respectively.</li> </ul> <p>To re-select all the objects originally in the multiple selection, click on the Selection Tool box's <input type="checkbox"/> All button.</p>

## 2.4.2 Moving Objects

In this section, the procedures for moving objects are described.

### ■ How to Move an Object

PROCEDURE	REMARKS
<p>(1) Click on the desired object. The object's handles will appear, showing that it has been selected.</p> 	<p><b>Reference</b> 2.4.1 <i>Selecting Objects</i></p> <p>The keyboard's , , , and  keys can also be used when the object's handles are displayed.</p>
<p>(2) Place the cursor over the object, away from the handles, and after the cursor changes to , drag it to the desired location.</p> 	<p>If an object is too small to select and move (i.e. it is only scaled up or down), click on and drag the object while holding down the  key.</p> <p>Also, you can move the object by zooming out the screen or using the keyboard.</p> <p><b>Reference</b> 1.3.2 <i>Display Area (50%, 100%, 200%)</i></p> <p>To cancel the movement, click on the  icon.</p>





- To move an object horizontally or vertically, do so while holding the [Shift] key down. In this case, the object will be moved in either the horizontal or vertical direction where the moving distance is greater.
- To move and scale up/down an object, designating its coordinates can be used.

**Reference** 2.4.15 *Changing Coordinates*

### 2.4.3 Scaling Up/Down

Scaling means changing the size and proportion of an object. This function allows you to easily scale an object up (larger) or down (smaller). Be sure the object's handles are displayed as (■).

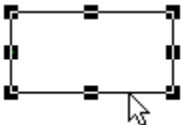
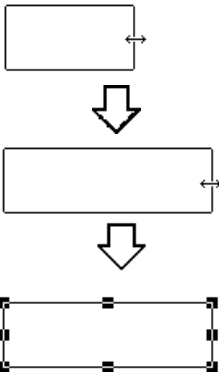





#### ■ Scaling An Object

PROCEDURE	REMARKS
<p>(1) Click on the object to select it. The object's handles will appear to show that it is selected.</p>  <p>(2) Place the cursor on an object's handle, and after the double arrow cursor appears, drag the handle to re-size the object.</p> 	<p><b>Reference</b> 2.4.1 <i>Selecting Objects</i></p> <p>Re-sizing will depend on which handle is dragged:</p> <p>Ex. To scale a square up or down:          Corner Handles = proportionally          Top/Bottom handles = vertically          Right/Left handles = horizontally</p> <p>Place the cursor on one of the handles of the object. When the cursor becomes ↔, use the keyboard's either ↑, →, ←, or ↓ key to scale the object up or down in the unit of dot.</p> <p>To cancel the re-sizing, click on the  icon.</p>
<p><b>Note:</b></p> <ul style="list-style-type: none"> <li>• When re-sizing an object while holding down the <b>Ctrl</b> key, lines will snap to 45 degree intervals, Rectangular and Scale (Linear) objects will become square-shaped objects, and ovals will become circles. Also, if the <b>Shift</b> key is held down, all selected Lines, Rectangles, Ovals, Scales, Text and loaded Marks will scale up or down proportionately.</li> <li>• When scaling a Part with a Label, holding down the <b>Ctrl</b> key causes the Label to scale up or down together with the Part.</li> <li>• When selecting an oblique line, 8 handles will be displayed. Click on the line again and 8 handles will change to 2 handles, one at either end. Clicking and then dragging on one end's handle "fixes" the opposite end in place, and "releases" the dragged end, and allowing the line to pivot freely.</li> <li>• Multiple parts may be selected and then scaled up/down. However, the following parts are not scaled up/down, but their positions are moved:</li> <li>• Half-pie Graphs, Pie Graphs, Meters, Trend Graphs, Alarms, Keypads, and Picture Displays.</li> <li>• To move and scale up/down an object, designating its coordinates can be used. <b>Reference</b> 2.4.15 <i>Changing Coordinates</i></li> <li>• When scaling the text with the Image Font, the text alone may exceed the scaling range.</li> </ul>	

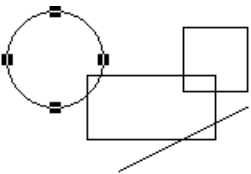
**2.4.4** **Cut**

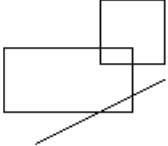
Here, the procedure for “cutting” an object (deleting it) and placing it on another screen, is explained. The object can also be placed elsewhere on the same screen, instead of using the Move procedure described in section 2.4.2. In addition, an object can simply be “cut” (deleted), and not placed anywhere. (When an object is “cut”, it is stored in the Clipboard\*1.)

**■ Cutting (Moving) an Object**





PROCEDURE	REMARKS
<p>(1) Select an object.</p> 	<p><b>Reference</b> 2.4.1 <i>Selecting Objects</i></p>
<p>(2) Select the [Edit] menu - [Cut] command, or click on the  icon. Then, the selected object will be cut.</p> 	<p>To cancel the Cutting, click on the  icon.</p>
<p>(3) Open the object’s destination screen, and select the [Edit] menu - [Paste] command, or click on the  icon. Then, the outline of the object cut from the previous screen will appear.</p>	
<p>(4) Position the cursor and click on the point where the object is to be placed. The object that had been Cut from the previous screen will be “pasted” at the new location.</p> 	<p>To cancel the pasting, click on the  icon.</p>

\*1 An area where text, graphics, or both, that have been Cut or Copied, are temporarily stored. The contents of the Clipboard can be “pasted” (copied from the Clipboard) using the Paste function. However, once the Copy/Cut command is executed, the data stored in the Clipboard is replaced; therefore, only the data from the most recent Copy/Cut command can be pasted.

**2.4.5 Copy**

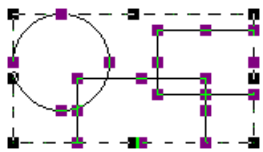
Here, the procedure for “copying” an object (without deleting it) and placing it elsewhere, is explained. (When an object is “copied”, it is stored in the Clipboard\*1.)

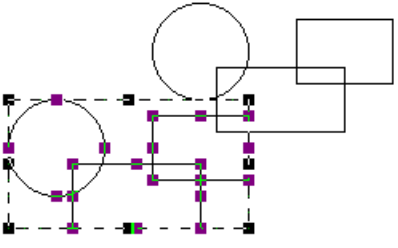
**■ Copying an Object**

PROCEDURE	REMARKS
<p>(1) Select the desired object(s).</p>  <p>(2) Select the [Edit] menu - [Copy] command, or click on the  icon. The selected object(s) will be Copied to the Clipboard.</p> <p>(3) Select the [Edit] menu - [Paste] command, or click on the  icon. Then, the outline of the object copied from the previous screen to the Clipboard will appear.</p> <p>(4) Position the cursor and click on the point where the object is to be placed. The object stored in the Clipboard will be Copied to the specified location.</p> 	<p><b>Reference</b> 2.4.1 <i>Selecting Objects</i></p> <p>To cancel the Copying, click on the  icon.</p> <p>When “pasting” the Copied object on another screen, be sure to open that screen first.</p> <p>Selecting and dragging an object to another screen while holding down the [Esc] key can also be used to copy the object.</p> <p>To cancel the pasting, click on the  icon.</p>





\*1 An area where text, graphics, or both, that have been Cut or Copied, are temporarily stored. The contents of the Clipboard can be “pasted” (copied from the Clipboard) using the Paste function. However, once the Copy/Cut command is executed, the data stored in the Clipboard is replaced; therefore, only the data from the most recent Copy/Cut command can be pasted.

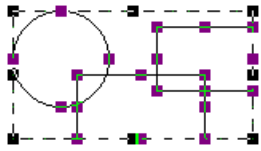

**2.4.6 Paste**

Here, the procedure for “pasting” an object, that has been Copied (or Cut) to the Clipboard\*1, is explained.

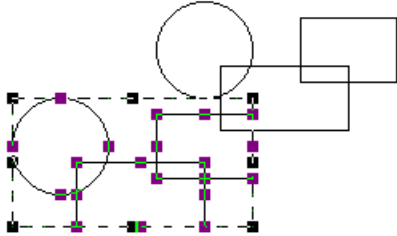
**■ Pasting an Object**

PROCEDURE	REMARKS
<p>(1)First, Copy (or Cut) an object.</p>  <p>(2)Select the [Edit] menu - [Paste] command, or click on the  icon.</p> <p>Then, the outline of the object copied from the previous screen to the Clipboard will appear.</p> <p>(3)Position the cursor and click on the point where the object is to be Pasted.</p> <p>The object stored in the Clipboard will be Pasted to the new location.</p> 	<p><b>Reference</b> 2.4.5 Copy</p> <p>To cancel the paste, click on the  icon.</p> <p>When an object is copied from another screen, it will be automatically placed at the same coordinates as its original ones. To place the object at different coordinates, move it after this automatic placement.</p>

\*1 An area where text, graphics, or both, that have been Cut or Copied, are temporarily stored. The contents of the Clipboard can be “pasted” (copied from the Clipboard) using the Paste function. However, once the Copy/Cut command is executed, the data stored in the Clipboard is replaced; therefore, only the data from the most recent Copy/Cut command can be pasted.

## 2.4.7 Duplicate

This command allows you to easily make multiple copies of any object. The address of the copies can be set up so as to increment automatically from copy to copy, or simply reuse the address of the original object.

### ■ Duplicate Setting Dialog Box

When this command is used, the Duplicate dialog box for entering the copy specifications, will appear as shown below.

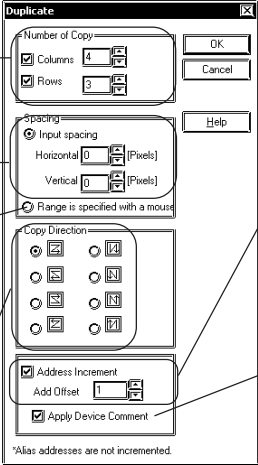

The screenshot shows the 'Duplicate' dialog box with the following fields and options:

- Number of Copy:** Includes checkboxes for 'Columns' (set to 4) and 'Rows' (set to 2).
- spacing:** Includes 'Input spacing' with 'Horizontal' and 'Vertical' fields (both set to 0) and a 'Range is specified with a mouse' option.
- Copy Direction:** Includes a grid of directional icons.
- Address Increment:** Includes 'Add Offset' (set to 1) and 'Apply Device Comment' (checked).

Annotations point to these fields with the following text:

- Enter the number of copies in the X and Y directions** (points to Columns and Rows)
- Enter the line spacing, in dot units** (points to Horizontal and Vertical spacing)
- Selects the area using the mouse in which the objects will be aligned with equal spacing.** (points to 'Range is specified with a mouse')
- Designates direction of copy placement, from original object** (points to Copy Direction icons)
- When copying Parts or Tags that require addresses, clicking here will automatically assign new, incremented addresses for each copy** (points to 'Apply Device Comment')
- The device comment corresponding to an address assigned by the automatic address increment is reflected in the Description field.** (points to 'Add Offset')

### ◆ Number of Copies

Here, how many times an object will be copied in the X and Y directions is entered. When "1" is entered for either direction, copying will not be performed in that direction.



**The number of copies that can be made will depend on the original object's position (on the screen), size, spacing and copy direction selected.**

### ◆ Input spacing

Enter the spacing interval of dot (screen pixel) units to be used when the object is copied for both the Horizontal and Vertical directions.



**When "Input spacing" is enabled, the position of duplicated objects is based on the top-left handle on the copied (original) object. However, if a Bar Graph's handles are located in a graph display area, the object will be placed based on the graph display area, not the graph's border. Therefore, when setting the spacing, be sure to not overlap any of the graphs' borders.**

### ◆ Range is specified with a mouse

The objects are automatically aligned with equal spacing in the area selected with the mouse.

### ◆ Copy Direction

This feature makes multiple copies, starting from original object's upper left "handle". It also designates the direction and positioning of the placement of the copies. The copy direction is shown by the arrow in each of the selection boxes. If the [Address Increment] feature is selected, each new object/copy created will be given a new address, based on the address entered for the original object.

### ◆ Address Increment

To copy multiple tags and parts, specify the direction of the automatic address increment. According to the automatic address increment, consecutive Addresses will be assigned in the direction designated by the [Copy Direction] feature. When the original object's Address is a Bit Address, the automatic address increment is performed in the unit of bit, and when it is a Word Address, the automatic address increment is performed in the unit of word.

If the automatic address increment is not used, tags and parts will be copied using the same address as their original ones.

E.g.) When duplicating with the settings shown below:

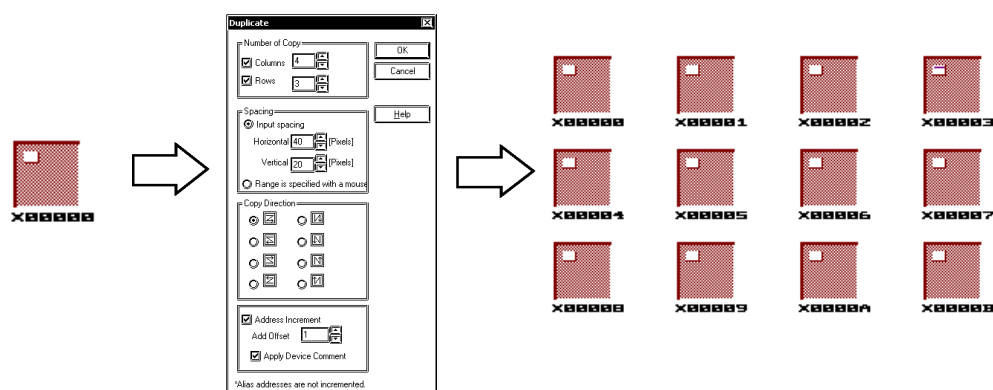

**Note:** • When address increment is used among different PLC numbers, it may not work properly.

### ◆ Reflection of Device Comments



When the [Apply Device Comment] check box is marked with a check, the device comment corresponding to an address assigned by the automatic address increment will be reflected in the Description Field. For tags designating multiple Addresses and Parts, however, the device comment corresponding to an Address designated as the Reflected Description Address is reflected. The Reflected Description Addresses for different tags and parts are shown in the table below:

<Reflected Description Address Table>

Object name	Automatic input address	Object name	Automatic input address	Object name	Automatic input address
A-tag	Monitor word address	R-tag		Lamp	Bit address
a-tag	Monitor word address	S-tag	Word address	4-state Lamp	Lamp Address 1
C-tag		T-tag (bit)	Bit address	Bar Graph	Word address
D-tag	Word address	T-tag (word)	Word address	Pie Graph	Word address
d-tag	Word address	T-tag (special)		Half-pie Graph	Word address
E-tag	Word address	t-tag	Bit address	Tank Graph	Word address
F-tag	Word address	Tih-tag		Meter Graph	Word address
G-tag	Word address	Tiw-tag		Trend Graph	Channel 0 word address
g-tag	Word address	U-tag	Word address	Keyboard	
H-tag	Start bit address	U-tag (high-speed)	Bit address	Keypad Input Display	Word address
J-tag	Word address	V-tag		Alarm	Word address
K-tag	Word address	v-tag		File Name Display	
k-tag		W-tag (bit)	Bit address	Data Logging Display	Block number designated address
L-tag (direct/indirect)	Start bit address	W-tag (word)	Word address	Numeric Display	Word address
L-tag (without indirect start bit)	Word address	W-tag (special)	Start bit address	Data Transfer Display	Word address
L-tag (state)	Word address	X-tag (bit)	Bit address	CSV Display	Word address
1-tag	Word address	X-tag (word)	Text screen word address	File Manager Display	Word address
M-tag	Start bit address	Trend channel	Word address	Message Display	Word address
M-tag (without start bit)	Word address	Data sampling	Sampling address	Date Display	
N-tag	Word address	Bit Switch	Operation bit address	Time Display	
n-tag		Word Switch	Word address	Graphic Display	Bit address
P-tag	Word address	Function Switch		Window Parts	Word address
Q-tag		Toggle Switch	Operation bit address		

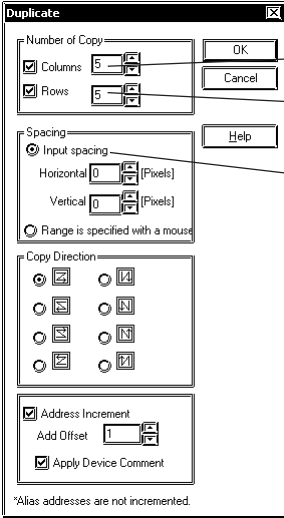
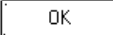
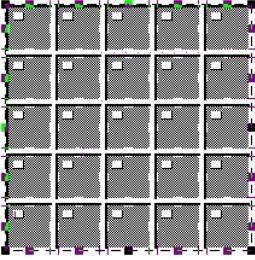

■ Duplicating

◆ When placing the duplicated object by specifying the spacing

PROCEDURE	REMARKS
<p>&lt;When Duplicating a Switch 5 times in both the X and Y directions&gt;</p> <p>(1) Select the desired object.</p>  <p>(2) Select the pull down [Edit] menu's [Duplicate] command.</p> <p>(3) Specify the number of copies to be made in both the X and Y directions.</p> <p>(4) Select the "Input spacing" option and then specify the spacing between copies (in dots) in the X and Y directions. Also select the desired option from the Copy Direction. If necessary, select the Address Increment check box and specify the setting.</p>  <p>(5) Click on the  button to duplicate the object.</p> 	<p>When duplicating an object, positioning will be decided based on the top left handle of the copied (master) object.</p> <p>To cancel the duplication, click on the  icon.</p> <p>To stop duplicating, press the  key.</p>

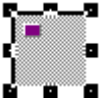
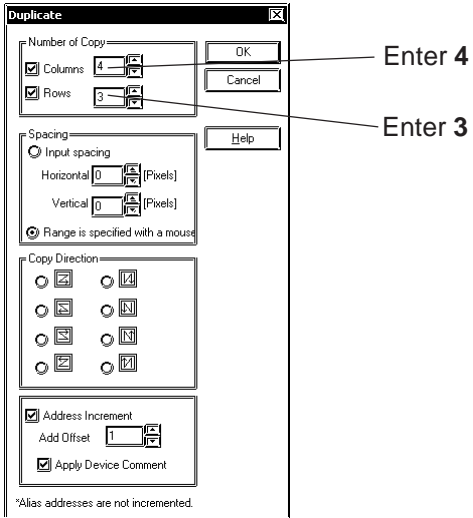
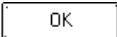
- ◆ When placing the duplicated objects by specifying the area with the mouse

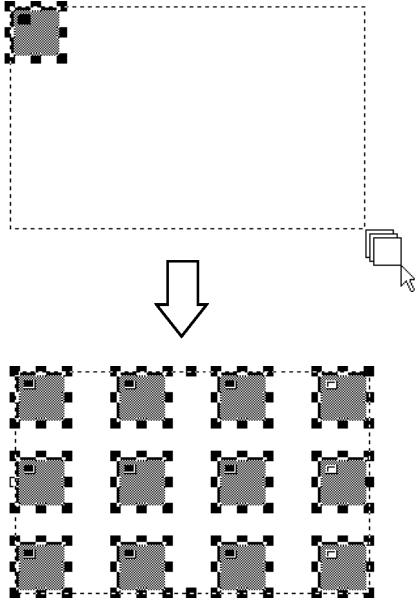

PROCEDURE	REMARKS
<p><b>&lt;When Duplicating a Switch 4 times in the X direction and 3 times in the Y direction&gt;</b></p> <p>(1) Select the desired object.</p>  <p>(2) Select the pull down [Edit] menu's [Duplicate] command.</p> <p>(3) Specify the number of copies to be made in both the X and Y directions.</p> <p>(4) Select the "Range is specified with the mouse" option and then specify the direction in which the object will be copied If necessary, select the Address Increment check box and specify the setting.</p>  <p>(5) Click  to confirm the settings.</p>	

PROCEDURE	REMARKS
<p>(6) Use the mouse to specify the area in which you want to place the duplicated objects. Click the mouse button to confirm the area and execute the Duplicate operation.</p> <p>The objects are placed with equal spacing in the specified area.</p> 	<p>Right-click the mouse or press the <b>Esc</b> key during Step (6) to return to Step (3).</p> <p>To cancel the Duplicate operation, click on the  icon.</p>

**2.4.8 Delete**

Here, the procedure for deleting an object is explained.

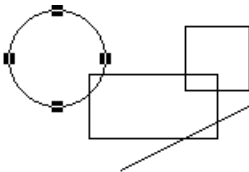
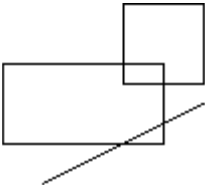
**■ Deleting an Object**

PROCEDURE	REMARKS
<p>(1) Select an object.</p>  <p>(2) Select the pull down [Edit] menu's [Delete] command.</p> 	<p>Instead of selecting the [Delete] command, the computer keyboard's <b>Delete</b> key can also be used.</p> <p>To cancel the deletion, click on the  icon.</p>



**2.4.9** **Align**

Here, the procedure for aligning and centering object(s) are explained.

**■ Alignment Dialog Box**

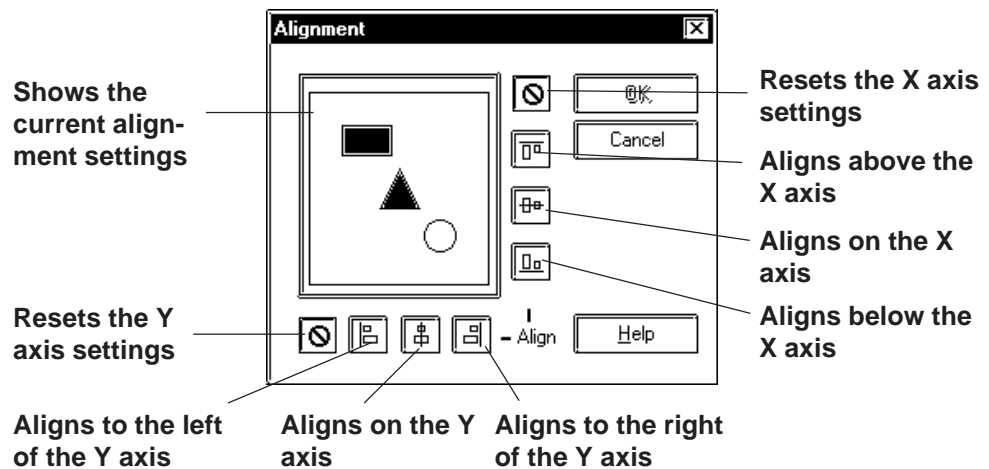





**■ Aligning Object Positions**

PROCEDURE	REMARKS
<p>(1) Select all the desired objects to be aligned.</p> <p>(2) Select the [Edit] menu - [Align] command, or click on the  icon.</p> <p>(3) Select the type of alignment from the Alignment dialog box. In this example, select the  icon (X-axis: Bottom) and do not select any vertical (Y-axis) position.</p> <p>(4) Click on the  button to align the objects.</p>	<p><b>Reference</b> 2.4.1 <i>Selecting Objects</i></p> <p>While an individual label can be aligned, groups of labels cannot. (Click on an object to select its handles and then click on its Label to select the Label's handles.) Text characters on both Numeric or other types of Displays can be aligned in the same manner.</p> <p>To align objects, combine the selections shown below:</p> <p>Horizontal position: Up, Center, Bottom</p> <p>Vertical position: Left, Center, Right</p> <p>To cancel the alignment, click on the  icon.</p>



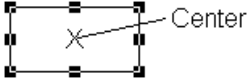

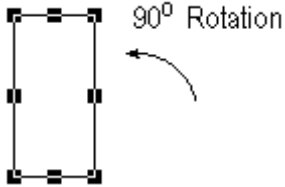
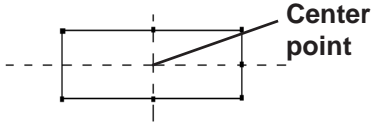

**2.4.10 Rotate Left/ Rotate Right**

With this command, an object can be rotated in 90° increments. However, loaded Screens and Marks, some Tags, and grouped objects cannot be rotated.

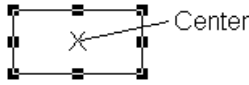
**■ Rotating an Object Counterclockwise (Left)**

PROCEDURE	REMARKS
<p>(1) Select an object.</p>  <p>(2) Select the [Edit] menu - [Rotate Left] command, or click on the  icon.</p> <p>The object will be rotated counterclockwise 90 degrees, relative to its center point; if necessary, repeat the command.</p> 	<p><b>Reference</b> 2.4.1 <i>Selecting Objects</i></p> <p>The center point of the object is where two lines, connecting the opposite handles (other than the corner handles), cross.</p>  <p>To cancel the rotation, click on the  icon. (Clicking on the  icon one time reverses one 90 degree rotation.)</p> <p>If an object is moved outside the drawing area by rotating, the object will not be displayed on the GP screen.</p>

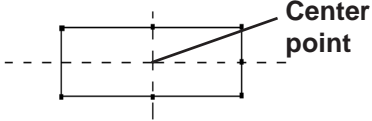



■ Rotating an Object Clockwise (Right)

PROCEDURE	REMARKS
<p>(1) Select a desired object.</p>  <p>(2) Select the [Edit] menu - [Rotate Right] command, or click on the  icon.</p> <p>The object will be rotated clockwise 90 degrees, relative to its center point. If necessary, repeat the command.</p> 	<p><b>Reference</b>  2.4.1 <i>Selecting Objects</i></p> <p>The center point of the object is where two lines, connecting the opposite handles (other than the corner handles), cross.</p>  <p>To cancel the rotation, click on the  icon. (Clicking on the  icon once reverses one 90 degree rotation.)</p> <p>If an object is moved outside the drawing area by rotating, the object will not be displayed on the GP screen.</p>



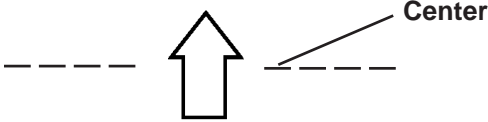

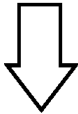
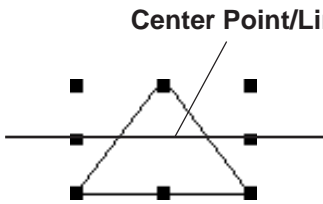

**2.4.11 Mirror X/ Mirror Y**

An object can be moved symmetrically around its center line with respect to the X or Y axis. The display position of Tags, Parts, Text, Load Screens, and Load Marks can only be moved symmetrically.

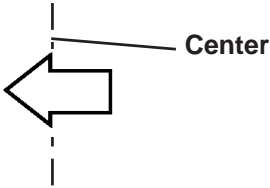
**■ Moving Symmetrically along the X-axis**

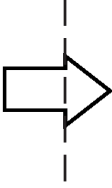
PROCEDURE	REMARKS
<p>(1) Select an object.</p>  <p>(2) Select the [Edit] menu - [Mirror X-axis] command, or click on the  icon.</p> <p>The object will move symmetrically with respect to the X-axis.</p> 	<p><b>Reference</b> 2.4.1 <i>Selecting Objects</i></p> <p>The center point of the object is where two lines, connecting the opposite handles (other than the corner handles), cross.</p>  <p>If an object is moved outside of the drawing area by using the Mirror X function, the part of the object outside the drawing area will not be displayed on the GP screen.</p> <p>To cancel the change, click on the  icon.</p>

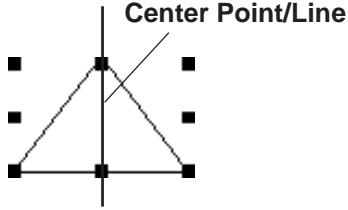



■ Moving Symmetrically along the Y-axis

PROCEDURE	REMARKS
<p>(1) Select an object.</p>  <p>(2) Select the [Edit] menu - [Mirror Y-axis] command, or click on the  icon.</p> <p>The object will move symmetrically around the Y axis.</p> 	<p><b>Reference</b>  2.4.1 <i>Selecting Objects</i></p> <p>The center point of the object is where two lines, connecting the opposite handles (other than the corner handles), cross.</p>  <p>If an object is moved outside of the drawing area by using the Mirror Y function, the overflowing part of the object will not be displayed on the GP screen.</p> <p>To cancel the change, click on the  icon.</p>

**2.4.12 Group/Ungroup**

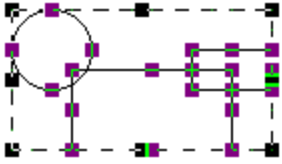
This function can be used to “group” multiple objects, enabling you to manipulate the “group” as a single object, even after changing screens or using a different editing function.

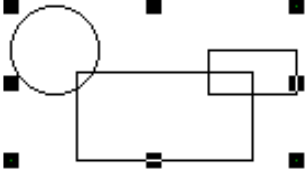
**■ Grouping Objects**

PROCEDURE	REMARKS
<p>(1) Select the objects to be Grouped.</p>  <p>(2) Select the [Edit] menu - [Group] command, or click on the  icon.</p> 	<p><b>Reference</b>  2.4.1 <i>Selecting Objects</i></p> <p>To cancel the Grouping, click on the  icon.</p>







- When a Part is included in a group, its handles appear as , so that the individual Part cannot be scaled up/down independent of the group. Thus, you must first ungroup the objects in order to scale any individual object.
- When a Part is included in a group, double click on the group to bring up the Confirm Device Address dialog box, where address changes can be made.

**Reference**  2.4.14 *Changing Attributes*

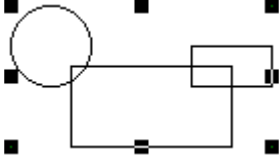
■ Ungrouping Objects









This function changes a Group of objects to a selection of multiple objects.

PROCEDURE	REMARKS
<p>(1) Select a group of objects.</p>  <p>(2) Select the [Edit] menu - [Ungroup] command, or click on the  icon.</p> 	<p><b>Reference</b> 2.4.1 <i>Selecting Objects</i></p> <p>To select a group including tags, place a check mark in the Tag check box in the Select Tool Box.</p> <p>To cancel the ungrouping, click on the  icon.</p>

**2.4.13 Bring to Front/ Send to Back**

When graphics and Parts overlap each other, you can change the order of the layers with these two commands.

**■ Changing the Order of Overlapping Objects**







PROCEDURE	REMARKS
<p>In this example, you will move the oval, partially hidden by the rectangle, to the front.</p> <p><b>[Bringing an Object Forward]</b></p> <p>(1) Use the cursor to select the filled oval.</p>  <p>(2) Select the [Edit] menu - [Bring to Front] command, or click on the  icon.</p>  <p><b>[Sending an Object Behind]</b></p> <p>(1) Use the cursor to select the black rectangle.</p>  <p>(2) Select the [Edit] menu - [Send to Back] command, or click on the  icon.</p> 	<p><b>Reference</b> 2.4.1 <i>Selecting Objects</i></p> <p>To cancel the movement, click on the  icon.</p> <p>To cancel the movement, click on the  icon.</p>

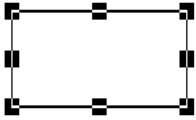

### 2.4.14 Changing Attributes

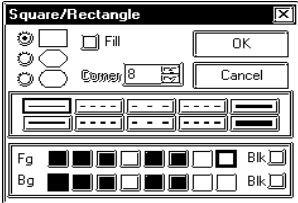
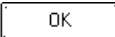
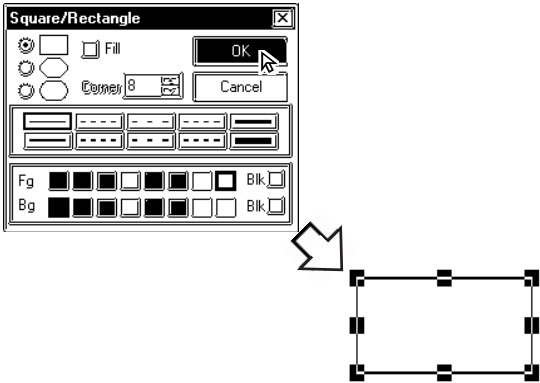
Here, you can change any of an object's attributes, i.e. its color, address, etc. Also, with objects of the same type, you can change the same attribute of all the objects of that type at the same time.

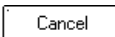
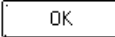
#### ■ Changing Attributes

PROCEDURE	REMARKS
<p>(1) First, select an object, to change its' attributes. In this case, an unfilled rectangle drawn with a solid line.</p>  <p>(2) Select the [Edit] menu - [Change Attribute] command, or click on the  icon.</p> <p>(3) Select a new attribute from the dialog box. Here, a dotted line is selected.</p>  <p>(4) Click on the  button to register your change.</p> 	<p><b>Reference</b> 2.4.1 <i>Selecting Objects</i></p> <p>While the attributes of Grouped objects generally, cannot be changed, the same type objects can be changed at the same time. When Grouped Parts have been selected, only their addresses can be changed.</p> <p><b>Reference</b> ■ <i>Confirming Addresses</i></p> <p>Instead of clicking on the  icon, simply double-click on the object when selecting it, to display the Attribute Settings dialog box ( skip step {2}).</p> <p>To cancel the attribute changes, click on the  button in the dialog box.</p> <p>Even after clicking on the , you can reverse the attributes changes (only for the most recent change) by clicking on the  icon.</p>

**Note:** You can select more than one object of the same type and change the attributes of each, at the same time. With all the desired objects selected, click on the Tool box's  button; then, proceed with step (2).

**Reference** 2.4.1 *Selecting Objects*, ■ *How to Select Multiple Objects*, [*Selecting Objects by Type from a Multiple Selection*]

## ■ Confirming Addresses

If a Part that requires an address has been grouped, the Confirm Device Address dialog box shown below will appear whenever its attributes are changed; the Part addresses are changed here.

Allows you to view either the Bit or Word Addresses of all the Parts in the currently selected group of objects

Part Addresses are displayed here

Check this box to automatically change all the addresses of the Parts in this group that have the same Device Address

Address	Function	Parts Name	Part ID	Description
X00000	Bit Set(Operation Bit)	Bit Switch	BS_001	
X00042	Bit Set(Operation Bit)	Bit Switch	BS_002	

## ◆ Bit and Word Addresses

Each Part's address is displayed. To change an address, click on the inside of each cell. As shown above, any Switches selected that have state changes will have both their Operation Bit and their Monitor Bit addresses displayed.

## ◆ Address Range Conversion

When an address is changed and this check box is checked, any other Part with the same device address will be automatically changed.

In the example above, if the first bit address is changed from X00000 to X00010, the following bit addresses will be changed as below.

Clicking on any cell other than the changed one will show the changed address

Address	Function	Parts Name	Part ID	Description
X00010	Bit Set(Operation Bit)	Bit Switch	BS_001	
X00042	Bit Set(Operation Bit)	Bit Switch	BS_002	

**2.4.15 Changing Coordinates**

Object positions and sizes can be changed by specifying their coordinates.

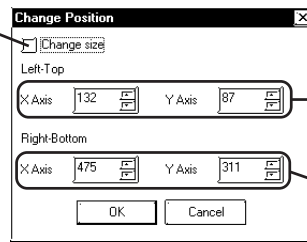

Check this check box to change the size.



Enter the object's left top coordinates.

Enter the object's right bottom coordinates.

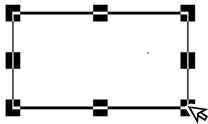
**■ Using Coordinates to Change an Object's Position**

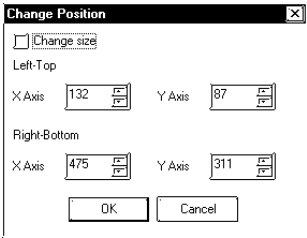
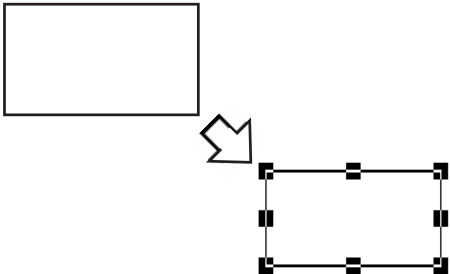
PROCEDURE	REMARKS
<p>(1) Select a desired object.</p> 	<p><b>Reference</b> 2.4.1 <i>Selecting Objects</i></p> <p>To change the size, check the Change size check box in step (3).</p> <p>To cancel the coordinates change, click on the <input type="button" value="Cancel"/> button.</p> <p>To undo the coordinates change, click on the  icon.</p>
<p>(2) Select the [Edit] menu - [Change Coordinates] command.</p>	
<p>(3) Enter the object's left top and right bottom coordinates.</p> 	
<p>(4) Click on the <input type="button" value="OK"/> button to execute the command.</p> 	

**2.4.16 Editing the Node of a Multi-segment Line**

Creating, Editing, or deleting a node can be performed on a multi-segment line and a filled polygon.

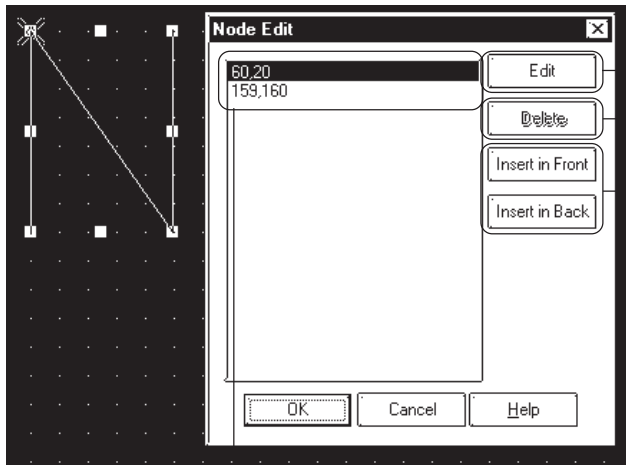

The [Node Edit] dialog displays.  
 Deletes the selected peak.  
 Adds a node. The added node is the same as the selected node. If the screen capacity is exceeded by the added value, the [Insert in Front] and [Insert in Back] buttons are highlighted and cannot be specified.

If the node edit is selected, the selected point in the displayed dialog is marked with a cross.

**■ Editing a Node on a Continuous Line**

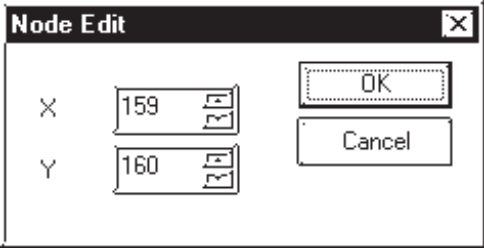
PROCEDURE	REMARKS
<p>(1) Select the desired continuous line.</p> <p>(2) Select [Node Edit(K)] from [Edit(E)].</p> <p>(3) Select the coordinate value that you want to edit.</p> <p>(4) Click on the <input type="button" value="Edit"/> button.</p> <p>(5) Enter the X/Y coordinate values in the coordinate change dialogs.</p>  <p>(6) Click on the <input type="button" value="OK"/> button to run the coordinate change.</p>	<p><b>Reference</b> 2.4.1 <i>Selecting Objects</i></p> <p>To cancel the coordinate change, Click on the <input type="button" value="Cancel"/> button.</p>

**2.4.17** Transferring a Screen to the Clipboard

The current screen is transferred as an image to the clipboard\*1. The transferred screen can be utilized by pasting it to other drawing software. The screen types that can be transferred to the clipboard are the Base (B) screen, Mark (M) screen, Trend Graph (T) screen, Keypad (K) and Window (U) screen.

■ Transferring a Screen to the Clipboard

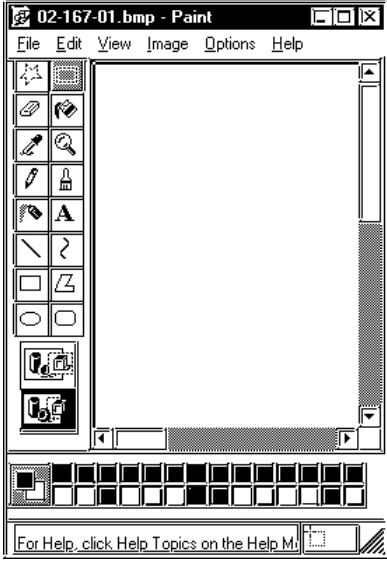
PROCEDURE	REMARKS
<p>(1) Select the [Screen to clipboard] command from the [Edit] menu. The current screen will be transferred to the clipboard.</p> <p>(2) Paste the screen to other drawing software.</p> 	

\*1 The clipboard is a storage location where copied or cut data is temporarily stored. The data stored on the clipboard can be copied or moved by pasting it.

**2.4.18** **Converting a Screen to a Bitmap File**

The current screen is converted into a bitmap file, and then saved. The screen types that can be converted are the Base (B) screen, Mark (M) screen, Trend Graph (T) screen, Keyboard (K) and Window (U) screen.

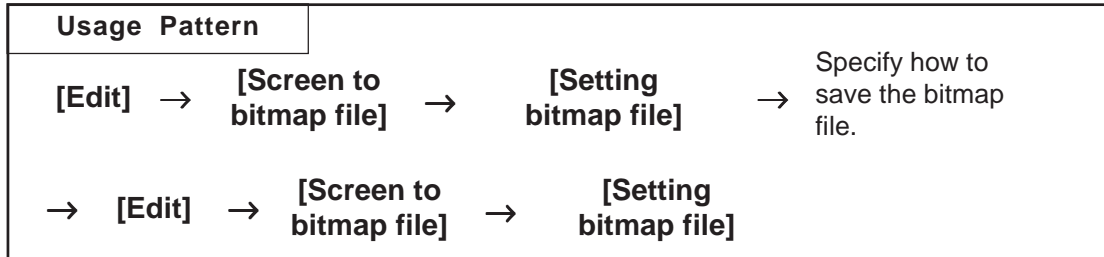

■ **Designating a Bitmap’s File Name**

Before converting the screen to a bitmap file, specify how to save the bitmap file.

Specify a file name and output destination to save the file.

Automatically creates a file name to save the file.

Specify an output destination of the file when a file name is being created automatically.

Specify how a file name is to be created automatically.

◆ **Prompt for filename when saving**

When the [Screen to bitmap file] command is executed, the Save As dialog box will appear, where you can specify the location and name of the file to be saved.

◆ **Automatically create file name**

When the [Screen to bitmap file] command is executed, a file name will be created automatically, and the file saved in a previously specified location.

Example: If the No. 1 screen of the Base (B) screen named “Menu” is converted into a bitmap file:

Screen type + number.BMP → B1.BMP

Screen type + number + screen title.BMP → B1 Menu.BMP



**Note:** When automatically creating a bit map file with a screen title, if one of the following symbols "\, /, ;, \*, ? " < > |" is used in the screen title, Windows® cannot create a file. Prior to using this feature, be sure your screen titles do not contain any of these characters.

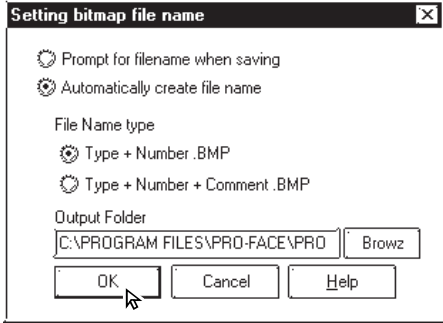
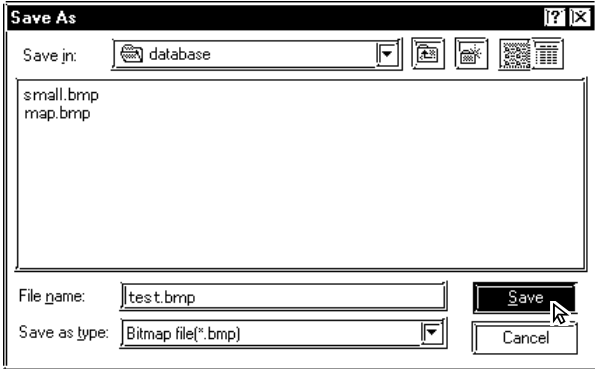

■ Converting a Screen into a Bitmap File

PROCEDURE	REMARKS
<p>(1) Select the [Setting bitmap file] option for the [Screen to bitmap file] command from the [Edit] menu.</p> <p>(2) Select a method for saving the bitmap file, and establish it by clicking on the <input type="button" value="OK"/> button.</p>  <p>(3) Select the [Screen to bitmap file] option for the [Screen to bitmap file] command from the [Edit] menu. When a file name is created automatically, the bitmap file is saved now.</p> <p>(4) If [Prompt for filename when saving] was selected in step (2), specify a file name and output destination, and then click on the <input type="button" value="Save"/> button.</p> 	<p>Save the source screen before performing the conversion. If the source image has not been saved, the bitmap file cannot be created automatically.</p>

**2.4.19 Redraw Screen**

This command updates the current drawing area display to reflect the latest drawing data. When the Auto Redraw feature is not used, filling and editing objects can cause after-images to remain on the screen. Use this function to remove these images and show the screen as it will appear on the actual GP display.

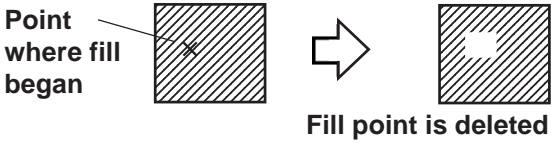
**■ Redrawing a Screen**

PROCEDURE	REMARKS
<p>Sometimes, when removing an object's filled color, only the fill point area's color will be removed, resulting in a small, non-colored square.</p>  <p><b>Point where fill began</b></p> <p><b>Fill point is deleted</b></p> <p><b>(1) Select the [Edit] menu - [Redraw] command, or click on the  icon.</b></p> <p>The screen will automatically be refreshed and all the fill color will be removed.</p> 	



**2.4.20 Undo**

With this function, an operation can be “undone” and the screen display returned to the previous condition. Every time the  icon is clicked on, depending on memory, previous operations will be undone, in succession.



**The Redraw Screen function cannot be undone.**

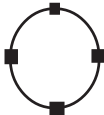

■ **Canceling an Action**

PROCEDURE	REMARKS
<p>In this example, a circle has been accidentally deleted.</p> <p>(1)Select the [Edit] menu - [Undo] command, or click on the  icon.</p> <p>The circle will reappear and the screen is displayed as it was prior to the deletion.</p> 	<p>To cancel the Undo operation, click on the ___ icon.</p> <p><b>Reference</b> 2.4.21 Redo</p>

**2.4.21 Redo**

With this function, an operation previously undone with the Undo command can be “redone”, if performed immediately after the Undo command is used.

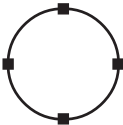
■ **Redoing the Previous Undo Command**

PROCEDURE	REMARKS
<p>In this example, the undone circle deletion will be redone (i.e. deleted again).</p> <p>(1)Select the [Edit] menu - [Undo] command, or click on the  icon.</p> <p>The circle will reappear.</p>  <p>(2)Select the [Edit] menu - [Redo] command, or click on the ___ icon.</p> <p>The circle will disappear.</p>	<p>To cancel the Redo operation, click on the  icon.</p> <p><b>Reference</b> 2.4.20 Undo</p>

## 2.5 Libraries

The objects you created can be registered. These registered objects are called “Libraries”. You can call up and use the registered Libraries, whenever necessary. Like a pre-made Part Shape, the objects registered in these libraries can be viewed and selected using the Browser function. Multiple objects can be combined and registered, and Marks created on Mark screens can also be registered.

**Reference** 3.1 *Creating a Mark: the Mark Screen*

These items are stored in a Library file (CPW file), separate from Project (PRW) files. When library data is a Mark, it will be saved in a Mark Library (MRK) file. Moving from one Library file to the other allows objects to be called up that were previously used in a variety of screens and Project files.

To call up an item from a Library, or save an item to a Library, either select one of the tool bar’s icons  or use the pull down menu’s [Library] commands.



**Note:** With both Base and Mark screens open, when the Base screen where the Library Browser is remained open is changed to the Mark screen, the Mark Library Browser cannot be open on the Mark screen. When changing the screen, first close the Library Browser and change the screen, and then open the Library Browser on the newly opened screen.

Objects called up via the [Load Screen], [Load Mark] or [Window Parts (W)] command, as well as D-script cannot be registered.

### Library Browser

When either  or  icon is clicked on, the Library Browser will appear.

Displays the currently selected item’s registration number and title; clicking on the triangle brings up a list of the items in the current library

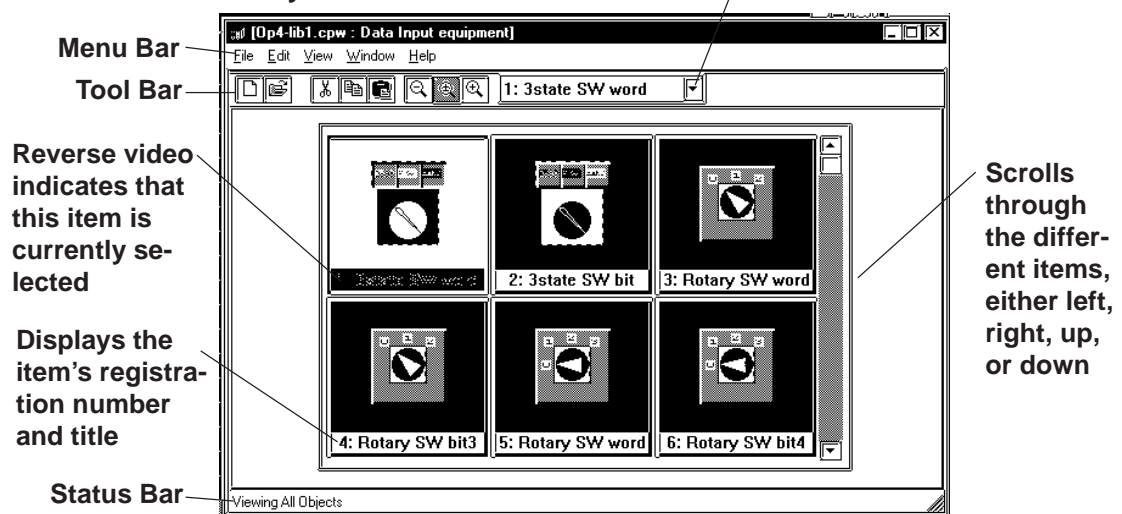

## ■ Editing Library Items

Three Library Item editing functions are available.



Cuts a Library item (which is then moved to the Clipboard); the Library item can then be moved to another screen using the [Paste] function.



Copies the selected Library item to the Clipboard.



Pastes the Library item Cut or Copied, and temporarily stored in the Clipboard, to another screen. The Library item can also be Pasted to another Library file.



You can remove a Library item using the Delete function. To do so, select the [Delete] command from the Library dialog box's pull down [Edit] menu.

### ▼ Reference ▲ 2.5.3 Editing Library Items

## ■ Changing the Library's Display

The Library's image display size and type can be changed. Also, you can change from one Library file to another.

### ◆ Library Size

When either the , , or  icon is clicked on, or the pull down [View] menu's either [Normal], [Adjust to Fit], or [Full Screen] command is selected, and the Library display size can be changed. When Normal is selected, each Library size will be displayed relatively, allowing you to check the relationship between Libraries for their size. When the Adjust to Fit function is selected, the Library item will be enlarged until it fits inside the Library window's borders. When Full Screen is selected, the Library item will be displayed in its actual (GP) screen size.

### ◆ Library Type

When the pull down [View] menu's [All Objects], [Part & Tag Objects], or [Graphic Objects] is selected, the Library type(s) shown on the Browser can be selected.

[All Objects]	Displays all the Library items in the selected Library file.
[Part & Tag Objects]	Displays only those items that are either Parts or Tags.
[Graphic Objects]	Displays only those items which are neither Parts nor Tags (i.e. drawn objects).

■ **Switching Library Files**

◆ **Creating a New Library File**

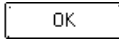
When the  icon is clicked on, or the pull down [File] menu's [New] command is selected, the Dialog box shown below will appear. When a Description is input and the  button is clicked on, a new Library file will appear.

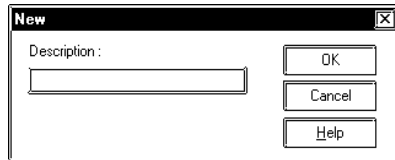

◆ **Selecting (Calling Up) another Library File**

When the  icon is clicked on, or the pull down [File] menu's [Select File] command is selected, the Library file list will appear. By selecting (dragging) the desired Library file from this list, other Library files can be called up.

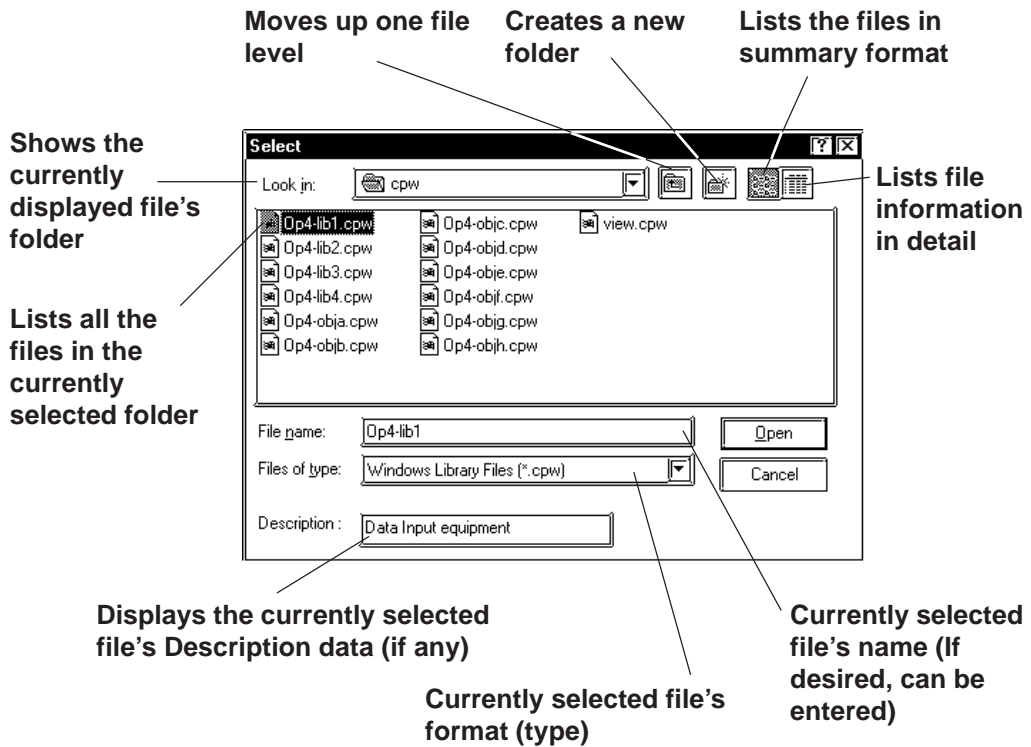

Two types of Library files are available; the Library files created using the GP-PRO/PBIII (DOS Version) (DOS Library file: \*. CPL), and the Library files created using GP-PRO/PBIII (Windows® Version) (Windows Library file: \*. CPW and \*.MRK). Select either one.

Files created using Parts Box (\*. CPL) can be converted into GP-PRO/PBIII for Windows format (\*. CPW).

**Reference** *12.1 File Converter*

### ■ Modifying Library File Names (Titles)

Library filenames can also be changed. Simply select a library from the file list, then select [Property] from the [Edit] menu, and the Property screen will appear. Type in the filename (title) that you wish to use and click on OK.

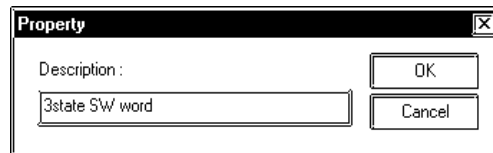









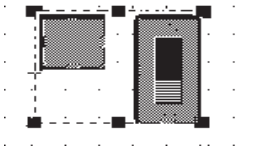

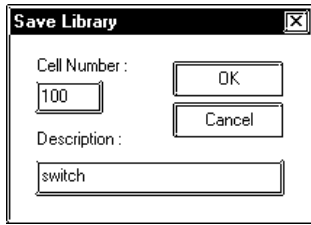
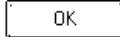
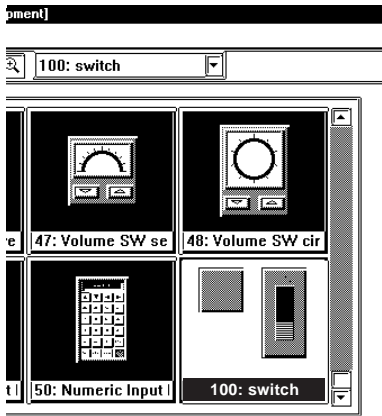
### ■ Displaying the Browser at the Top of the Normal Screen

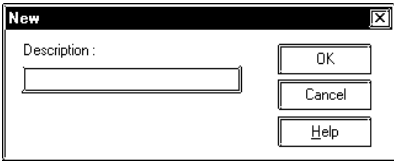
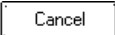
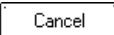
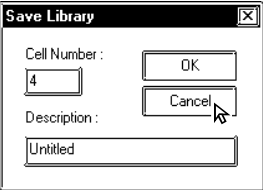

If the [Always on Top] option is selected from the [Window] menu, whenever the Library Browser is called up, it will be placed at the top of the current window. If this option is not selected, selecting another screen will place that screen over the Library screen, hiding it from view.

**2.5.1 Registering Library Items**

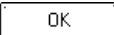
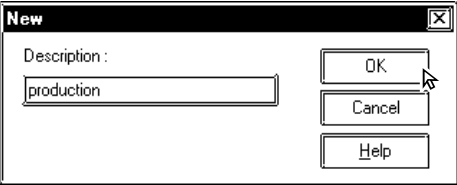

Here, the procedure for registering a Library is explained.

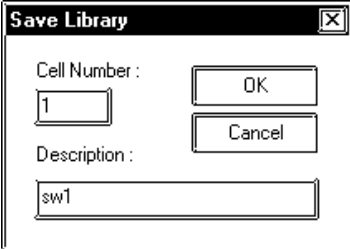
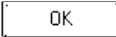
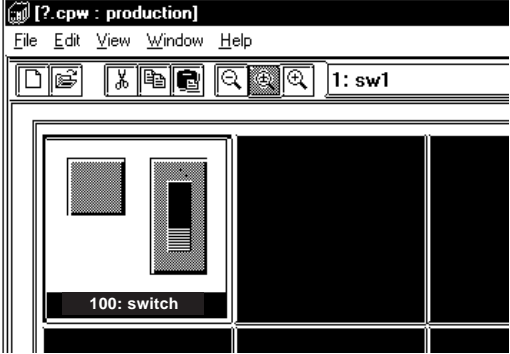
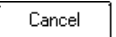
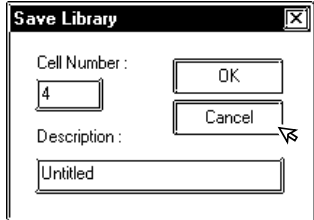
PROCEDURE	REMARKS
<p>(1) Select objects to be registered as Library items.</p>  <p>(2) Select the [Library] menu - [Register Library] command, or click on the  icon.</p> <p>&lt;A. When registering a new Library item to the currently open Library file:&gt;</p> <p>(3) Enter the Library's registration number and description.</p> <p>In the Cell Number area, the smallest of the currently open Library file's unused numbers will be automatically displayed. To change it, simply enter the desired number.</p>  <p>(4) Click on the  button to register the number.</p> <p>The registered Library will then be displayed in the Browser.</p> 	<p><b>Reference</b> 2.4.1 <i>Selecting Objects</i></p> <p>D-scripts as well as objects called up via the [Load Screen (O)], [Load Mark (M)] and [Window Parts (W)] commands cannot be registered.</p> <p>If the Library Browser is already showing, click on either  or  icon in the screen editor drawing area, and the  icon in the Library Browser, which will perform the function of step (2).</p> <p>The following procedures will differ depending on the Library file registered.</p> <ul style="list-style-type: none"> <li>• When registering a new Library item to the currently open Library file:</li> <li>• When no Library file is displayed:</li> <li>• When registering a Library item to a new Library file:</li> <li>• When registering a Library item to a Library file other than the currently open one:</li> </ul> <p>Up to 200 Library items can be registered in one file.</p>

PROCEDURE	REMARKS
<p>&lt;B. When no Library file is displayed:&gt;</p> <p>(3) The “New” dialog box will appear.</p>  <p>When registering a Library item to a new Library file. &lt;C. When registering a Library to a new Library file&gt;'s step (5)</p> <p>When registering a Library item to an existing Library file: Click on the  button.</p> <p>&lt;D. When registering a Library item to a Library file other than the currently open one&gt;'s step (4)</p> <p>&lt;C. When registering a Library item to a new Library file:&gt;</p> <p>(3) Click on the  button.</p>  <p>(4) Via the Library Browser, select the [File] menu - [New] command, or click on the  icon.</p> <p>(5) Enter a comment and click on the  button.</p>  <p>(6) Via the Screen Editor, select the [Library] menu - [Register Library] command, or click on the  icon.</p>	<p>Enter the file name when the Library file is saved.</p> <p><b>Reference</b> 2.5.4 Saving Libraries and Quitting ■ Saving a Library File Under Another Name</p> <p>A comment of up to 60 characters can be entered.</p> <p>Enter a description up to 60 characters.</p> <p>Enter the file name when the Library file is saved.</p> <p><b>Reference</b> 2.5.4 Saving Libraries and Quitting ■ Saving a Library File Under Another Name</p>

PROCEDURE	REMARKS
<p>(7) Enter a Cell Number and Description.</p>  <p>(8) Click on the  button. The newly registered Library item will appear in the Browser.</p>  <p>&lt;D. When registering a Library item to a Library file other than the currently open one.</p> <p>(3) Click on the  button.</p>  <p>(4) Via the Library Browser, select the [File] menu - [Select File] command, or click on the  icon.</p>	<p>A maximum of 200 Library items can be registered in each Library file.</p> <p>After creating a new Library item, if you attempt to create or select another Library file without first saving the item via the [Save As...] function, a prompt will appear, asking whether the newly created Library item should be saved or not.</p> <p><b>Reference</b> For the procedures for saving a Library item, refer to <i>2.5.4 Saving Libraries and Quitting</i> ■ <i>Saving a Library File</i></p>

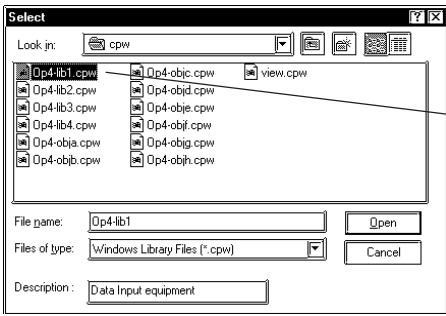
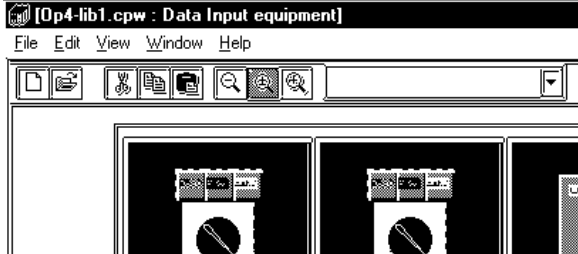

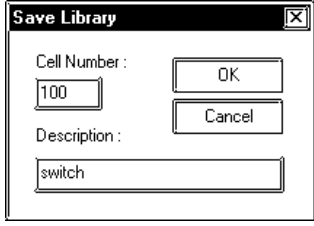
PROCEDURE	REMARKS
<p>(5) Select the desired Library file from the list, or input the Library file name in the file name area.</p>  <p>(6) Click on the <input type="button" value="Open"/> button to display the selected Library file.</p>  <p>(7) Via the Screen Editor, select the [Library] menu - [Register Library] command, or click on the  icon on the Draw Tool Bar.</p> <p>(8) Input a Cell Number and Description.</p> <p>In the Cell Number area, the smallest of the currently open Library file's unused numbers will be automatically displayed. To change it, enter the desired number.</p> 	<p><b>Reference</b> 2.5 Libraries ■ <i>Switching Library Files</i></p> <p>When selecting a Library file in another directory, use the [Look in:] window.</p> <p>In step (5), simply move the cursor to the desired Library file name and double-click on it to open it. By doing so, the <input type="button" value="Open"/> (Step 6) button does not need to be used.</p>

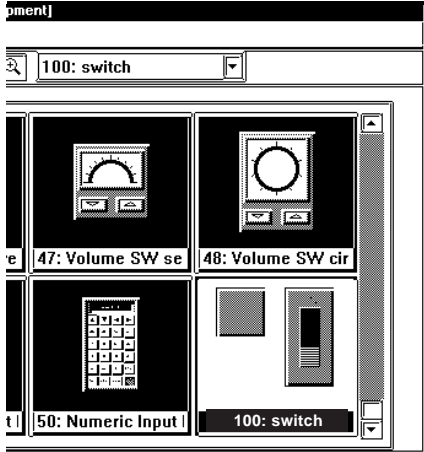



PROCEDURE	REMARKS
<p>(9) Click on the <input type="button" value="OK"/> button to register the item.                      The registered Library item will appear in the Browser.</p> 	<p>Up to 200 libraries can be registered in one file.</p>

■ Using the Cut, Copy, and Paste Functions

Library items can be Cut, Copied and Pasted from the screen drawing area to Browser. First, select the desired Library item in the drawing area, and then either Cut or Copy it; then, Paste it to the current Library Browser.

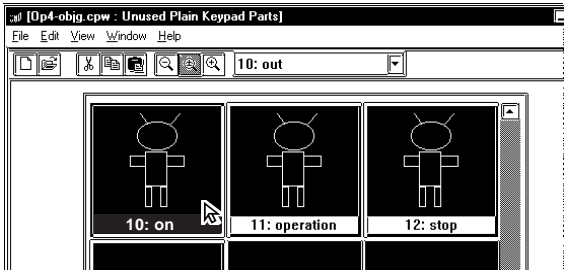
**2.5.2 Placing Library Items**

Here, items registered in a Library file are placed on a drawing area.

PROCEDURE	REMARKS
<p>(1) Via the Screen Editor, select the [Library] menu - [Call Up Library] command, or click on the  icon on the Draw Tool Bar.</p>	
<p>(2) Select a Library Item to be read out from the Browser.</p> 	<p>Library items Cut, Copied, or Pasted between the screen and the Browser. Simply select the desired Library item and perform the command.</p> <p>When calling up an item from a file different than the currently displayed file, click on the  icon to bring up a file list.</p>
<p>(3) Drag the Library item to the desired position in the drawing area.</p> <p>The Library item can be placed on any open screens, and will be displayed in the drawing area. If desired use the sizing handles to alter the item's size.</p>	<p><b>Reference</b> <i>2.5 Libraries</i>  <b>Switching Library Files</b></p>
	<p>The Library item's top left corner is the placement point.</p> <p>To cancel the placement, click on the screen editor's  icon.</p> <p><b>Reference</b> To change a Library item's size, refer to <i>2.4.3 Scaling Up/Down</i></p> <p>Items called up are automatically grouped. They can be freely edited after ungrouping them by clicking on the  icon.</p> <p><b>Reference</b> <i>2.4.12 Group/Ungroup</i></p> <p>Grouped library items containing Parts cannot be scaled up or down.</p>

When a Library that contains Parts is called up, the Confirm Device Address screen will appear. After entering each Part's address, click on the  button. To cancel these settings, click on the  button.

**Reference** 2.4.14 Changing Attributes, ■ Confirming Addresses

When the Library placed on the screen is double-clicked on, the Confirm Device Address dialog box shown below will appear, allowing you to change the Part's previously entered addresses.

Address	Function	Parts Name	Part ID	Description
X00010	Bit Set (C)	Bit Switch	BS_012	
X00042	Bit Set (C)	Bit Switch	BS_013	



**After a Tag is registered in a Library, if multiple identical libraries are then placed on the screen, their Tag names will be duplicated. After placing them, be sure to change their Tag names via either their attribute dialog boxes, or the Tag List; especially if a common start up bit has been created for a K-tag.**

**Reference** For Changing Attributes, refer to 2.4.14 Changing Attributes.  
 For Tag List, refer to 2.10.6 Tag List.  
 For K-tags, refer to *Tag Reference Manual, 2. 12 K-tag (Keypad Input)*.

### ■ Using the Cut, Copy, and Paste Functions







Library items can be Cut, Copied, and Pasted from the screen drawing area to the Browser. First, select the desired Library item in the drawing area and Cut or Copy it; then, Paste it to the Library Browser.

**2.5.3 Editing Library Items**

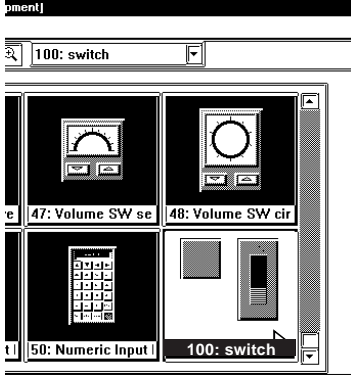
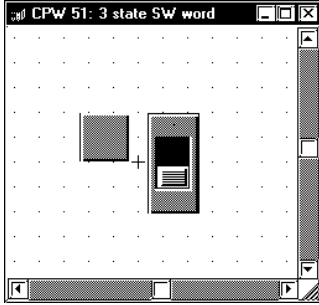
Library Items can be edited, Deleted, Copied, Cut, or Pasted.

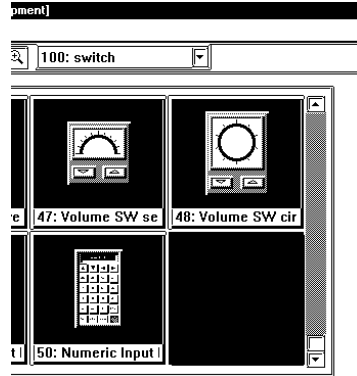

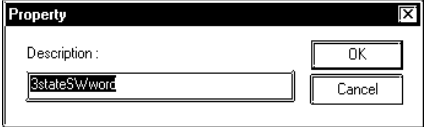
**■ Editing a Library Item**

Here, a registered Library item is edited.

PROCEDURE	REMARKS
<p>(1) Select and double-click the Library item to be edited from the Browser.</p>  <p>(2) Edit that Library item.</p>  <p>(3) Via the Screen Editor, select the [Screen] menu - [Save] command, or click on the  icon on the Main Tool Bar.</p> 	<p>In order to call up a Library item from a Library file which is different from the currently displayed file, click on the  icon.</p> <p><b>▼ Reference ▲ 2.5 Libraries</b>  <b>■ Switching Library Files</b></p> <p>When double-clicking on a Library item's title, the title editing screen will appear. (Title Change Screen)</p>  <p>  <b>Important</b>  <b>Once an item is edited, it cannot be Undone.</b></p>



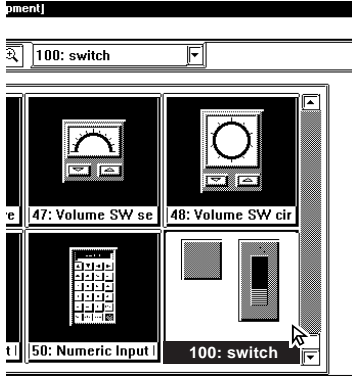
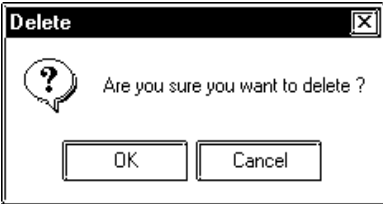
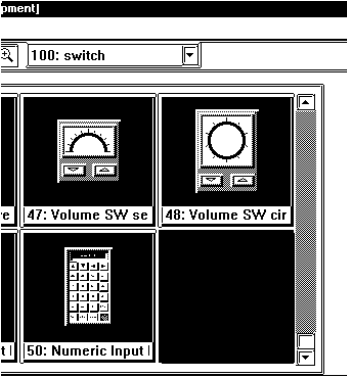



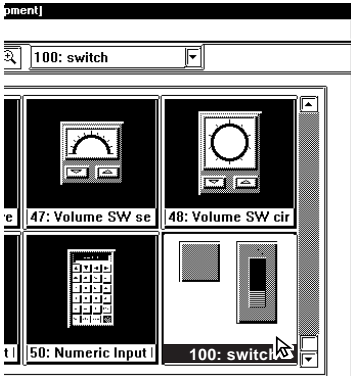

**■ Deleting a Library Item**

Here, a registered Library item is deleted.

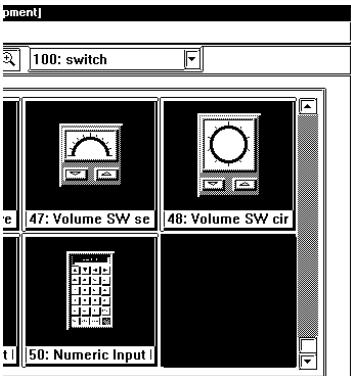
PROCEDURE	REMARKS
<p>(1) Select the Library item to be deleted from the Browser.</p>  <p>(2) Select the [Delete] command from the Library Browser's [Edit] menu. A dialog box appears to confirm your command.</p>  <p>(3) Click on the <input type="button" value="OK"/> button, and the Library item will be deleted.</p> 	<p>In order to call up a Library item from a Library file which is different from the currently displayed file, click on the  icon.</p> <p><b>Reference</b> 2.5 Libraries  <b>■ Switching Library Files</b></p> <p><b>Important</b>  <i>Once an item is deleted, it cannot be Undone.</i></p>

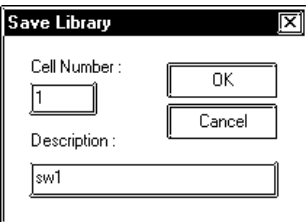
■ Cutting a Library Item (from a Library File) and Pasting





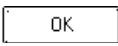
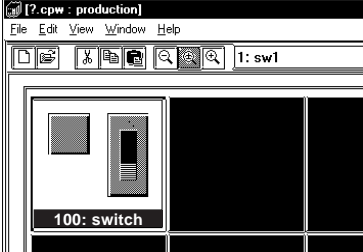

Here, a registered Library item is Cut and Pasted.

PROCEDURE	REMARKS
<p>(1) Select a Library item to be cut (out) from the Browser.</p>  <p>(2) Via the Library Browser, select the [Edit] menu - [Cut] command, or click on the  icon. The selected Library will be cut.</p>  <p>(3) Open a desired Library file and, via the Library Browser, select the [Edit] menu - [Paste] command, or click on the  icon.</p> <p>The following steps are the same as those used for a Library Item registration.</p> <p>(4) Input the Item's Cell Number and Description.</p> <p>In the Register Number area, the smallest number in the currently open Library file's empty numbers will be automatically displayed. To change it, input the desired number.</p> 	<p>In order to call up a Library item from a Library file different than the currently displayed Library file, click on the  icon.</p> <p>▼ <b>Reference</b> 2.5 Libraries          ■ Switching Library Files</p> <p>To register the Library item to a new Library file, click on the  icon.</p> <p>To register the Library item to a Library file different from the currently displayed one, click on the  icon.</p> <p>▼ <b>Reference</b> 2.5 Libraries          ■ Switching Library Files</p>

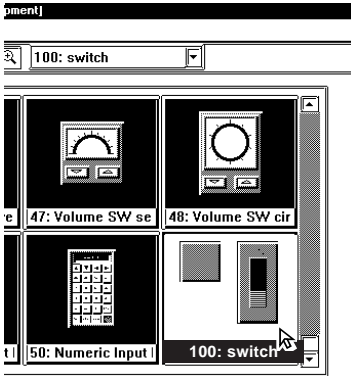
PROCEDURE	REMARKS
<p>(5) Click on the  button to register the Library Item. The registered Library will be displayed on the Browser.</p> 	

**■ Copying a Library Item**

Here, a previously registered Library item will be copied.

PROCEDURE	REMARKS
<p>(1) Open the desired Library Item's Library file and select the Library item from the Browser.</p>  <p>(2) Via the Library Browser, select the [Edit] menu - [Copy] command, or click on the  icon. The Library item will be copied to the Clipboard.</p> <p>(3) Open the destination Library file and select the [Edit] menu - [Paste] command, or click on the Library Browser's  icon.</p>	<p>In order to call up a Library item from a Library file different than the currently displayed Library file, click on the  icon.</p> <p><b>Reference</b> <i>2.5 Libraries</i>  <b>■ Switching Library Files</b></p> <p>To register the Library item to a new Library file, click on the  icon.</p> <p>To register the Library item to a Library file different than the current one, click on the  icon to call up a list of Library files.</p> <p><b>Reference</b> <i>2.5 Libraries</i>  <b>■ Switching Library Files</b></p>

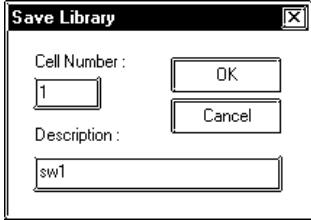
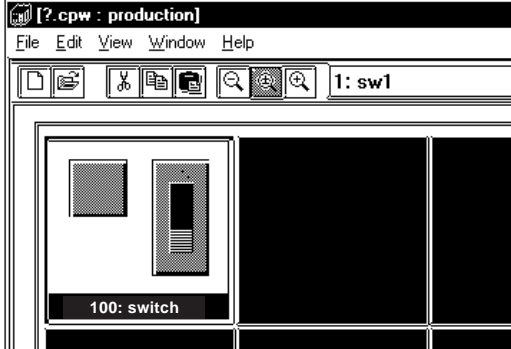

PROCEDURE	REMARKS
<p>Hereafter, steps are the same as Library Item Registration.</p> <p><b>(4) Input the Item's Cell Number and Description.</b>            In the Register Number area, the smallest of the currently open Library file's unused numbers will be automatically displayed. To change it, enter the desired number.</p>  <p><b>(5) Click on the <input type="button" value="OK"/> button to register the Item.</b>            The registered Item will appear in the Browser.</p> 	

**2.5.4 Saving Libraries and Quitting**

**■ Saving a Library File**

When a Library file’s contents are changed, the changed data will automatically overwrite the old data and be saved. However, if the Library file has been newly created, when you attempt to create or select another Library file, a prompt will appear asking if whether the new file is to be saved or not. When  is clicked on, the [Save As...] Dialog box will appear.

**▼ Reference ▼ ■ Saving a Library File Under Another Name**

**■ Saving a Library File Under Another Name**

Here, the Library File will be saved under a different name.

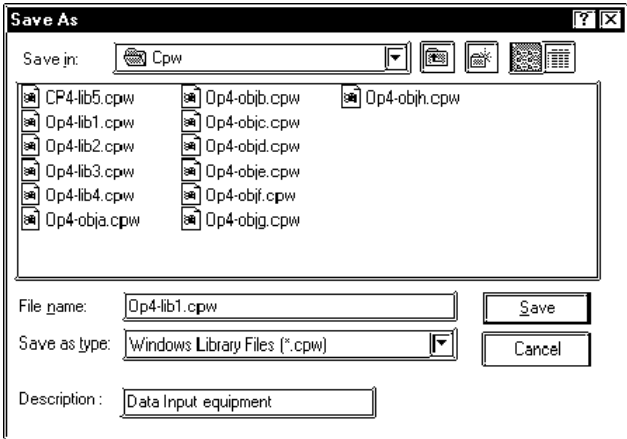
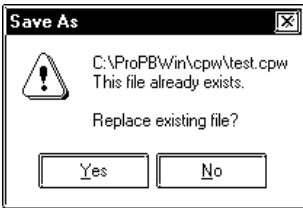
PROCEDURE	REMARKS
<p>(1)Select the [Save As...] command from the Library Browser’s [File] menu.</p> <p>(2)The currently selected Library file name and its comment data, if any, will appear. Input a new file name and change the desired settings.</p>  <p>(3)Click on the <input type="button" value="Save"/> button to save the Library. When a project with the same name already exists, a prompt asking whether the new name should overwrite the old name will appear; to do so, click on the <input type="button" value="Yes"/> button. When you do not want to overwrite, click on the <input type="button" value="No"/> button.</p> 	<p>The file name can be input within 255 characters, including a path and extension.</p>

■ Quitting the Library Browser

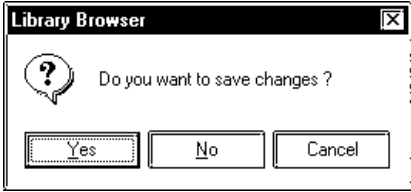
PROCEDURE	REMARKS
<p>(1) <b>Select the pull down menu [File]’s [Exit] command.</b>                      If a newly created Library file has not been saved yet, a prompt asking whether the new Library file should be saved, will appear. When the <input type="button" value="Yes"/> button is clicked, the “Save As..” dialog box will appear, and when the <input type="button" value="No"/> button is clicked, the Library file will not be saved and the Library Browser will quit. Then, a Library file creation or selection screen will appear.</p> 	<p>Clicking on the Library Browser’s top right mark <input type="button" value="X"/> can also be used to quit.</p> <p><b>Reference</b> ■ <i>Saving a Library File Under Another Name</i></p>

## 2.6 D-Script/Global D-Script

The GP-PRO/PB III provides a special feature that enables you to create a program to execute functions, in addition to tags. This feature is given by D-Scripts/Global D-Scripts. The display load on the device can be reduced significantly by creating and registering a program with D-Scripts/Global D-Scripts. D-Scripts are used on each screen and serve as programs that are only effective on that screen. Global D-Scripts serve as programs that are effective on all screens.

Using D-Script, you can program separately for when the trigger is activated and for when the action is performed.

. Then, when the trigger conditions are satisfied, the script is performed. The procedures for writing a program with Global D-Scripts are the same as those for writing a program with D-Scripts.

For more detailed info **Reference** D-script and Global D-script, refer to the Tag Reference Manual. Tag Reference Manual, 3.1 D-Script/Global D-Script



- **D-script and Global D-script cannot be registered as Libraries.**
- **To set up D-scripts or Global D-scripts, open any desired Base screen and follow the procedure below.**

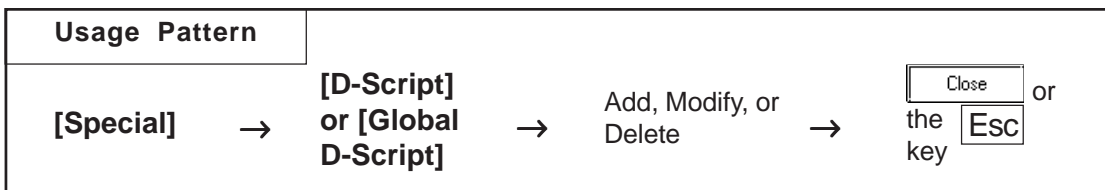

An example of the D-Script dialog box (the initial screen) is shown below.

**Lists the D-Script ID numbers and descriptions**

**Adds a D-Script**

**Deletes a registered D-Script**

**Allows you to edit the contents of a D-Script**

**Copies the contents of a D-Script**

**Pastes the copied contents of a D-Script**

■ Registering D-Script Settings

Here, additional D-Scripts can be registered. When the **Add** button is clicked on, the D-Script Editor will appear.

**Enter the D-Script's ID No. (from 00000 to 99999)**

Enter a description here

Displays the D-Script's command tool box

The programmed "actions" (commands) of the D-Script  
Only the command portions ("actions") can be imported/exported as text files (\*.txt).

Trigger area

Displays defined function names

**Message area (window)**

■ D-Script Tool Box

The D-Script tool box contains icons for D-Script commands and Statements and constant input icons.

**Reference** *Tag Reference Manual, 3.1 D-Script/Global D-Script*

When the "Show Toolbox" check box is checked, the following tool box will appear.

## ■ Definition of Functions

Programs to be used for D-Script are defined as functions. The defined functions can be called up to the activated program and used. Also these functions can be nested up to 10 layers. When the  icon is clicked on in the D-Script Editor, the D-Script function setting screen will appear.

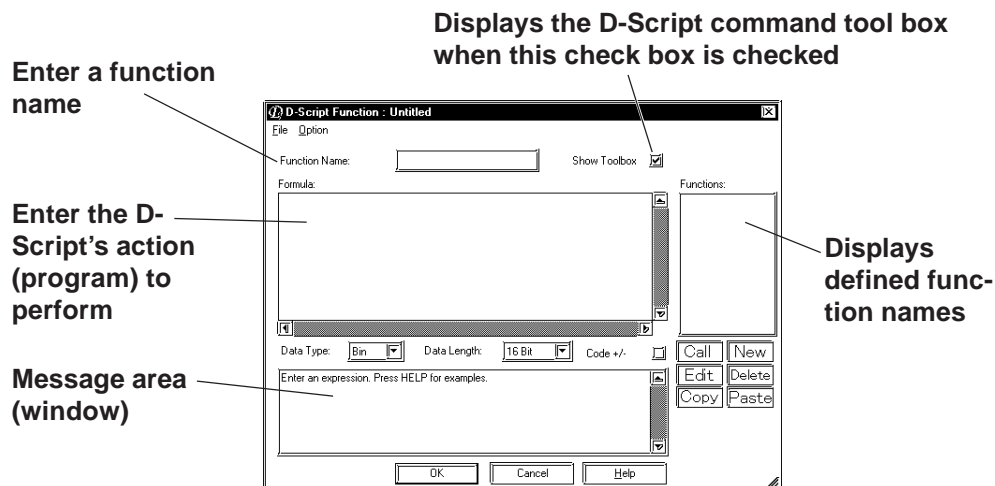

**Note:** Only alphanumeric and the “\_ (under bar)” can be used for function names; up to 20 characters can be entered.

## ■ Importing/Exporting the "Action" information on the [D-Script Editor]/[D-Script Function] dialog box

Information on the program currently being displayed in the [Formula] field of the [D-Script Editor] dialog box or in the [Formula] field of the [D-Script Function] dialog box can be imported/exported as a text file (\*.txt).

**Note:** Information on items other than [Formula] (the information displayed in [Trigger], [Function], and Message area (window), etc.) cannot be imported or exported.

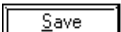
To export the information, select the [File] menu-[Export] command. When the [Save As] dialog box opens, enter a desired file name and click the  button.

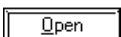
To import the information, select the [File] menu-[Import] command. When the [Open] dialog box opens, select the desired text file containing the program information and click the  button.

### ■ Deleting D-Script Settings

Here, existing D-Script settings can be deleted. After selecting the D-Script settings to be deleted from the listing, and clicking on the  button, the Confirm Script Delete dialog box will appear. When the  button is clicked on, the D-Script settings will be deleted. When the  button is clicked on, the deletion command will be canceled.

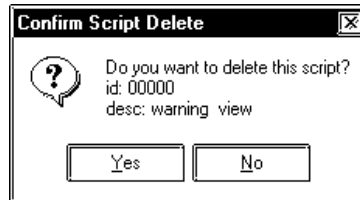

### ■ Editing D-Script Settings

Here, registered D-Script settings are changed. After selecting the D-Script settings to be changed from the D-Script list and clicking on the  button, an additional registration screen will appear. Click on the  button to change the D-Script settings. To cancel the Change command, click on the  button.



- ***If the [Save As..] function has been used to change a project file's Device/PLC Type, the D-Script program will not be able to automatically change those addresses. When changing addresses, use the [Project | Change Device/PLC Type] menu's "Convert Address" feature. For details about this feature, see Reference 4.2.7 Changing Your Project's Device/PLC Type and Addresses***
- ***Be sure to not use D-Script to perform any life-threatening, or possibly damaging actions!***

■ D-Script Settings: Copy and Paste

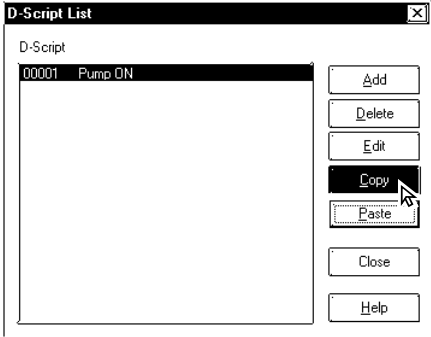
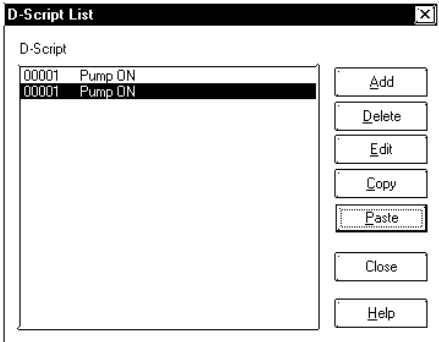
PROCEDURE	REMARKS
<p>(1) Select the pull down [Special] menu's [D-Script] command.</p> <p>(2) Click on the <input type="button" value="Copy"/> button.</p>  <p>(3) When the <input type="button" value="Paste"/> button is clicked on, the D-Script copied in step (2) will be added. The D-Script's ID number will automatically be assigned to the smallest number currently available.</p> 	<p>This D-Script can also be copied to another screen.</p>



■ Registering D-Script settings

The method for registering D-Script settings is shown below.

For a temperature controller, D-Script detects the device's error bit and displays alarm messages when the temperature rises to 70 °C or above, or has fallen lower than 30°C. Also, the number of the errors detected are counted.

When error bit M0001 turns ON...

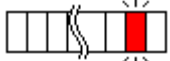

If the temperature has risen to higher than 70°C, screen B100 is displayed.

If the temperature has fallen to lower than 30°C, screen B101 is displayed. Also, the number of occurrences is counted.

ALARM  
Over 70 deg. !!

ALARM  
Under 30 deg. !!

Above 70

Below 30

- Temperature data is stored in D200.
- When the temperature is 70 °C or more, the number of Alarms is stored in LS300.
- When the temperature is 30 °C or less, the number of Alarms is stored in LS301.
- The alarm display screen number is stored in LS302.

To display the above mentioned alarm messages, L and N-tags are used as follows:

- (1) Create the alarm message screens, B100 and B101.
- (2) Set up an L Tag to display the Alarm message screen. (Direct designation, word address: LS302)
- (3) Set up an N-tag to display the number of the errors counted when the temperature rises to 70 °C or more. (Word address: LS300)
- (4) Set up an N-tag to display the number of the errors counted when the temperature falls to 30 °C or less. (Word address: LS301)

▼ **Reference** ▲ For details concerning each Tag, refer to the *Tag Reference Manual, 1.3 Tag List.*

PROCEDURE	REMARKS
<p>(1) Select the pull down [Special] menu's [D-Script] command.</p> <p>(2) Click on the <input type="button" value="Add..."/> button.</p>	<p>The number of D-script registrations will be limited depending on each GP memory capacity.</p> <p>▼ <b>Reference</b> ▲ <i>Tag Reference Manual 3.1.4 D-Script/Global D-Script Limitations</i></p>

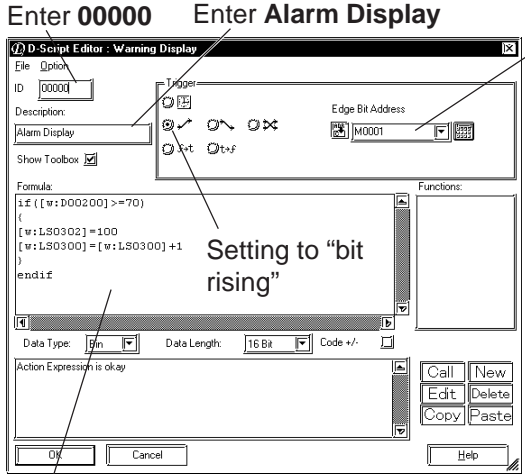
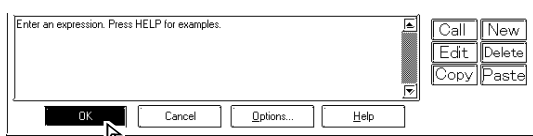
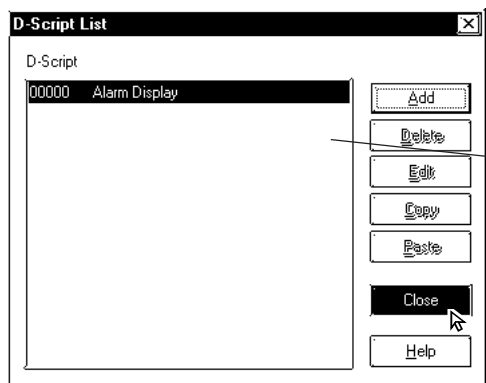
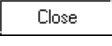
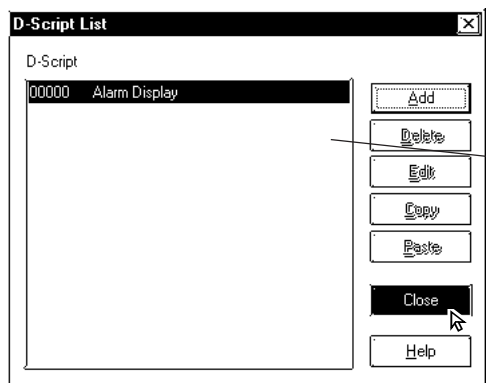
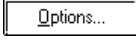
PROCEDURE	REMARKS
<p><b>(3) Perform settings for each item such as ID, Trigger, Formula, etc.</b></p>  <p>Enter <b>00000</b>    Enter Alarm Display    Enter <b>M0001</b></p> <p>Setting to "bit rising"</p> <pre> Program if ([W:D00200] &gt;=70) {     //When the temperature is 70°C or higher:     [W:LS0302] =100           //Assign screen No. 100 for the "Over 70°C" alarm message.     [W:LS0300] =[W:LS0300] +1 //The number of errors counted increases. } endif  if ([W:D00200] &lt;=30) { //When the temperature is 30°C or lower:     [W:LS0302] =101           //Assign screen No. 101 for the "Under 30°C" alarm message.     [W:LS0301] =[W:LS0301] +1 //The number of errors counted increases. } endif                     </pre>	<p>A description can be entered of up to 20 characters.</p> <p><b>Reference</b> <i>Tag Reference Manual, 3.1 D-Script/Global D-Script</i></p>
<p><b>(4) Click on the  button.</b></p>  <p><b>(5) Click on the  button to quit registration.</b></p>  <p>The current registration information is shown here.</p>	<p>In the  area, the Syntax Assistant and Syntax Check functions can be used.</p>

## 2.7 Extended SIO Script

The GPPRO/PB III provides a special programming function dedicated to communication between the GP and the I/O device connected to the extended SIO (Extended serial interface) built into the GP. The programming operation is executed independently of the processing of the tags on the screen. The Extended SIO Scripts function as a programming function that is effective on all screens in the Project, regardless of the screen type. Three special functions - D-script, Global D-script, and Extended SIO script - are available for creating programs to execute functions other than tags.

**Reference** For details of each function, *Tag Reference Manual*, 3.1 *D-Script/Global D-Script* and 3.2 *Extended SIO Script*.



- **This function is supported by GP2000 Series units .**
- **When the Extended SIO script is used with a GP unit that does not have an Extended Serial I/F, the “Serial I/F Switch” must be set to “Yes” in advance. Version 6.2 or later support the serial interface selection function.**

**Reference** 4.2.8 Changing Extended SIO Type

- **When using the Extended SIO Script, ensure that the [Extended SIO Script Protocol] option has been selected in the Extended SIO Settings. When a different Extended SIO is selected, the Extended SIO Script cannot be selected via the Screen Editor.**

**Reference** For the procedure for changing the Extended SIO type, 4.2.8 Changing Extended SIO Type.

- **The Extended SIO Script cannot be registered as a Library item.**
- **To set up the Extended SIO script, open any desired Base screen and follow the procedure below.**
- **The LS device used with the Extended SIO scripts cannot be simulated.**

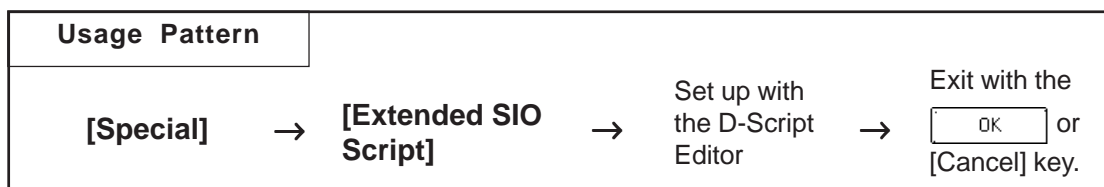

### ■ Setting the Extended SIO Script

Configure the Extended SIO Script settings on the D-Script Editor.

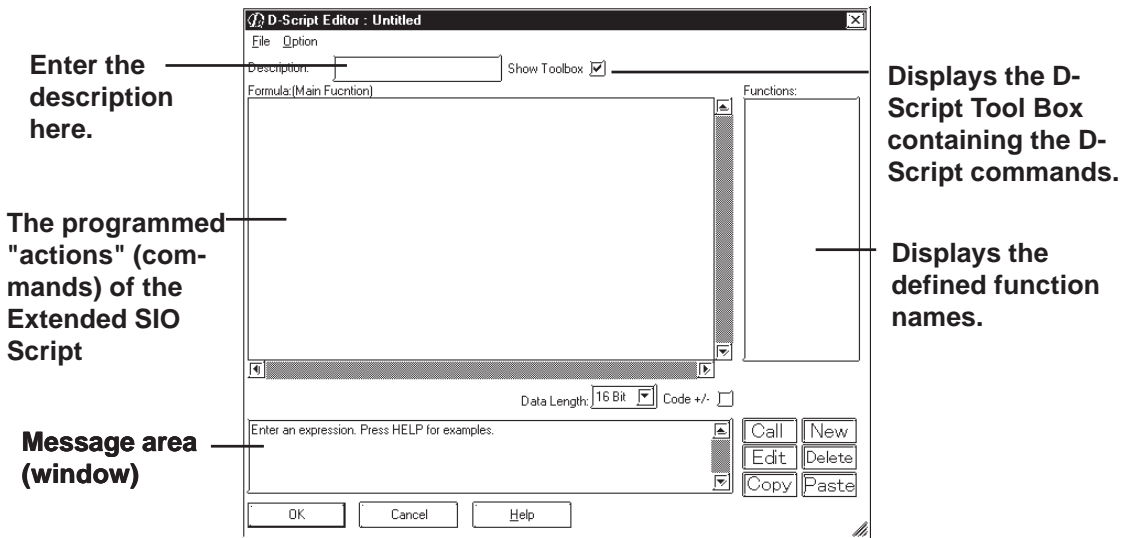

### ■ D-Script Tool Box

The D-Script toolbox contains the D-Script commands, Statements and constant input icons.

**Reference** *Tag Reference Manual, 3.1 D-Script/Global D-Script*  
 When the "Toolbox" checkbox is checked on the D-Script Editor, the following toolbox will appear.

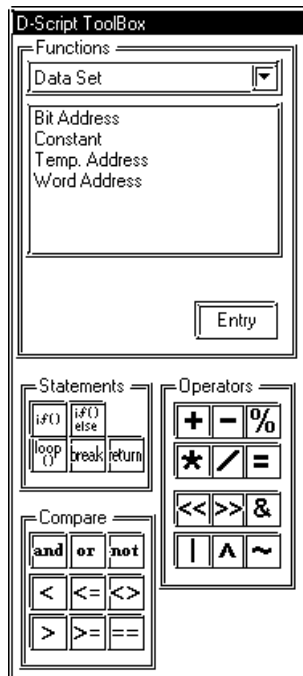

## ■ Definition of Functions

The programs to be used for Extended SIO Script are defined as functions. The defined functions can be called up to the activated program and used. These functions can be nested up to 10 layers.

When the  icon is clicked on the D-Script Editor, the D-Script Function setting screen will appear.

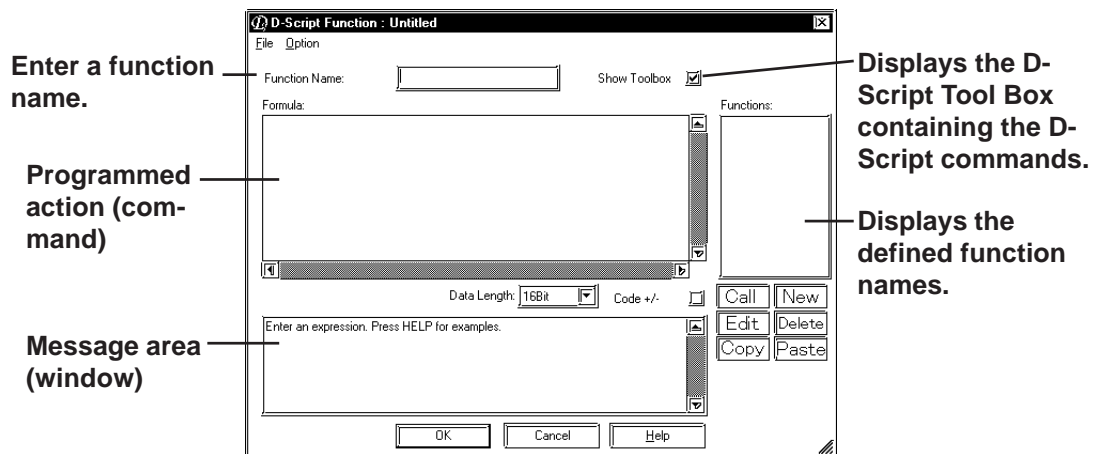

- Only single-byte alphanumeric characters starting with an alphabet character and "\_" (underscore) can be used for function names. Up to 20 characters can be entered.
- The functions defined in the [D-Script Function] dialog box of the Extended SIO Script cannot be used with the D-Script/Global D-Script.

## ■ Importing/Exporting the "Action" information on the [D-Script Editor]/[D-Script Function] dialog box

Information on the program currently being displayed in the [Formula] field of the [D-Script Editor] dialog box or in the [Formula] field of the [D-Script Function] dialog box can be imported/exported as a text file (\*.txt).

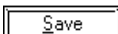

- Information on items other than [Formula] (Information displayed on [Function], and Message area (window), etc.) cannot be imported or exported.

To export the information, select the [File] menu-[Export] command. When the [Save As] dialog box opens, enter a desired file name and click the  button.

To import the information, select the [File] menu-[Import] command. When the [Open] dialog box opens, select the desired text file containing the program information and click the  button.



- **When the Project file's PLC type has been changed in the [Project] menu-[Save As] dialog box, the addresses used with the D-Script cannot be changed.**
- **Never use D-scripts to perform controls that have the potential to cause life-threatening injuries or serious damage.**

### ■ Setting the Extended SIO Script

The following is an example of the procedure for setting the Extended SIO Script.

On a temperature controller, the target value and current value displayed by the temperature controller are read out via the Extended SIO Script. The trigger is turned ON when the [Start Communication] touch switch is pressed, and the target value is displayed followed by the current value display. After 10 seconds, the target value and current value are read out and displayed again.

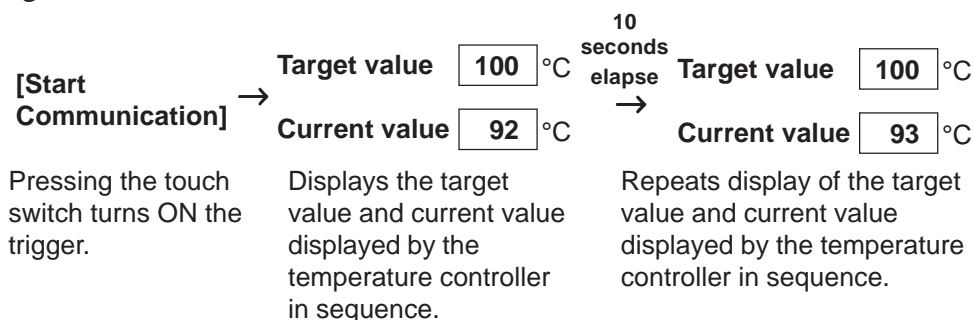

The target value of the temperature controller is stored in LS2000.  
The current value of the temperature controller is stored in LS2001.

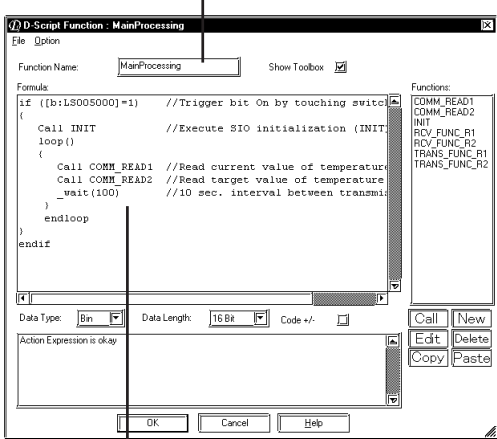
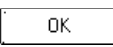
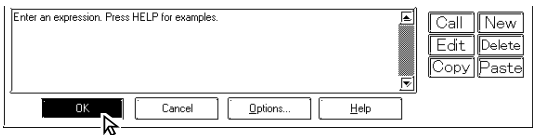
PROCEDURE	REMARKS
<p>(1) Select the pull down [Special] menu's [Extended SIO Script] command.</p> <p>(2) Configure the settings for each item, such as Description and Formula.</p> <p style="text-align: center;">Enter a description.</p>  <p style="text-align: center;">Programmed "actions" (Main Function)</p> <pre> if ([b: LS005000] ==1)           // When Trigger bit is ON with the touch switch: {   Call INIT                     // Executes initialization of the Extended SIO.   loop ()   {     Call COMM_READ1             // Reads out the current value of the temperature controller.     Call COMM_READ2             // Reads out the target value of the temperature controller.     _wait (100)                 // Waits the timer count period before starting transmission                                 // (10-second wait).   }   endloop } endif </pre> <p>(3) Click on the  button to confirm and quit the settings.</p> 	<p>The number of Functions of the Extended SIO Script setting is limited.</p> <p><b>Reference</b> <i>Tag Reference Manual, 3.2.2 Details</i></p> <p>Up to 20 single-byte characters can be entered as a description.</p> <p><b>Reference</b> <i>Tag Reference Manual, 3.2 Extended SIO Script</i></p> <p>Select [Option] from the menu to perform Syntax Assistant and Syntax Check functions.</p>

## 2.8 Data Sampling

Address data designated in the device is sampled and stored (backed up) in the GP unit. When using this function for a graph (Tag or Part)'s channel, Trend graph data can also be stored (backed up).

The number of Data Sampling sets, including the number of channels of Trend Graphs, that can be set up for the entire Project file (PRW file) is 40 with the GP2000 series and 20 with other models.

For more detailed information about data sampling, refer to the Tag Reference Manual.

**Reference** *Tag Reference Manual, 3.3 Data Sampling Settings*



An example of the Data Sampling Setting dialog box is shown below.

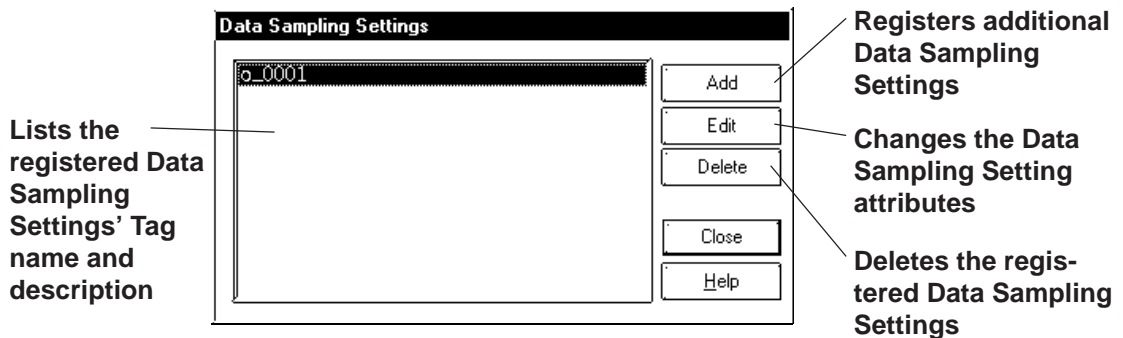



### ■ Registering Data Sampling Settings

Additional Data Sampling Settings are registered.

When the  button is clicked on, the Data Sampling Setting screen will appear. For each item's setting, refer to Tag Reference Manual.

**▼ Reference ▲** *Tag Reference Manual, 3.3 Data Sampling Settings*

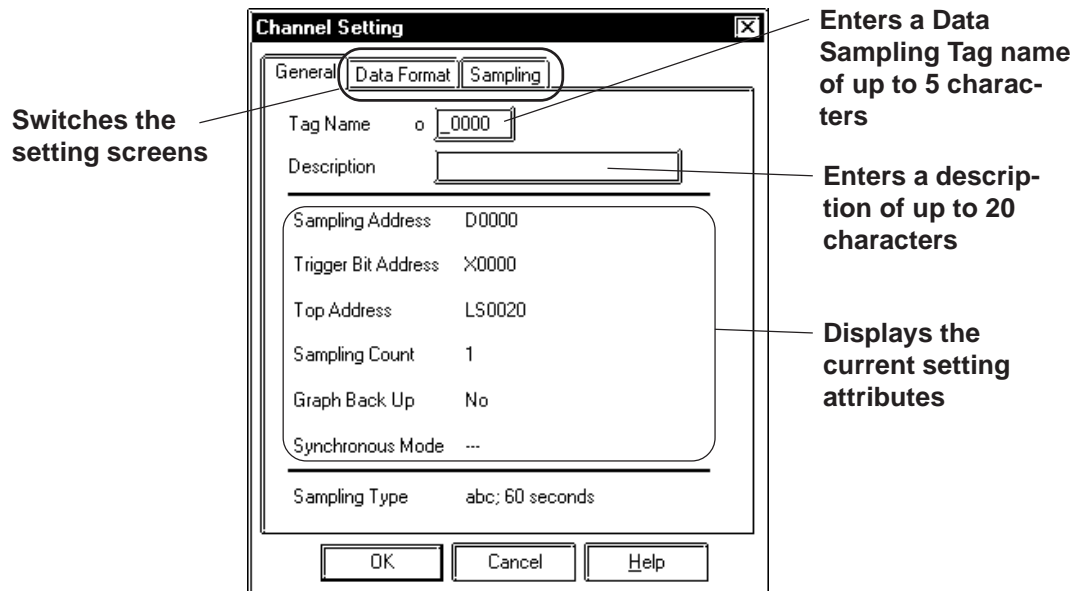

### ■ Deleting Data Sampling Settings

Here, the registered Data Sampling Settings can be deleted. Select a Data Sampling to be deleted from the list. When the  button is clicked on, a dialog box will appear to confirm your command. If you click on the

button, the Data Sampling will be deleted; if you click on the  button, the deletion will be canceled.

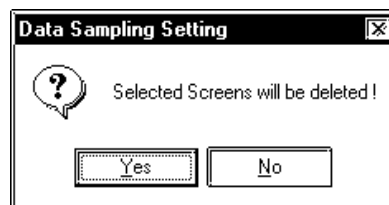



### ■ Editing Data Sampling Settings

Here, the registered Data Sampling Setting attributes can be changed. Select a Data Sampling to be changed from the list. When the  button is clicked on, the Add (registration) dialog box will appear. If you click on the

button, the D-Script setting attributes will be changed, and if you click on the  button, editing will be canceled.

■ **Setting Up Data Sampling**

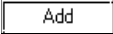
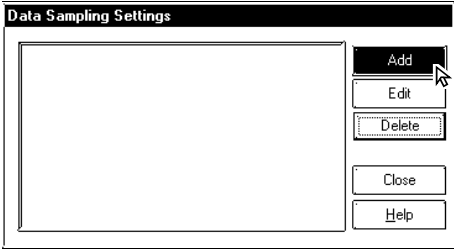
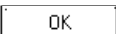
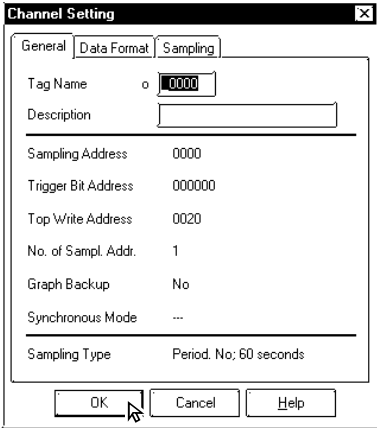
The Data Sampling setting method is shown below.

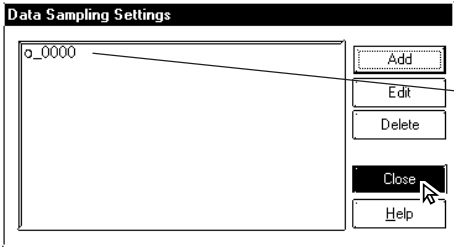
PROCEDURE	REMARKS
<p>(1) Select [Data Sampling] from the [Special] pull down menu.</p> <p>(2) Click on the  button.</p>  <p>(3) Perform the data sampling settings. After the settings are all completed, click on the  button.</p>  <p>(4) Click on the  button to quit the registration.</p>  <p style="margin-left: 400px;">Displays the registered items</p>	<p>The number of Data Sampling sets, including the number of channels of Trend Graphs, that can be set up for the entire system is 40 with the GP2000 series and 20 with other models.</p> <p>Enter a Tag name of up to 5 characters.</p> <p><b>Reference</b> <i>Tag Reference Manual, 3.3 Data Sampling Settings</i></p>

## 2.9

## GLOBAL INTERLOCK

The touch panel and function keys become effective only when the bit specified with "Interlock Address" is in the state that has been designated via "Touch available condition". All inputs from the touch panel and function keys are disabled when the "Touch available condition" is not satisfied. In the "Touch available condition", specify whether the inputs are effective in the ON state or in the OFF state.

Touch available condition	State of the Interlock Address	Touch Available/Not Available
Bit ON	ON	Touch Available
	OFF	Touch Not Available
Bit OFF	ON	Touch Not Available
	OFF	Touch Available



Important

- **This function is supported only by the GP2000 Series and ST Series.**

- **Specify an externally manipulated address (such as address of an external device or a variable to which I/O is allocated, etc.) for the "Interlock Address". When an address that cannot be operated externally is specified, the touch operation cannot be returned to the Available condition after the touch operation has been disabled.**



Note:

- **Even when the Touch available condition is not satisfied, the touch operations for switching to the Offline mode and adjusting the brightness or contrast, and touch operations in the Standby mode are enabled.**

The settings for Global Interlock can be checked with the Tag List (Global Interlock). **Reference** 2.10.6 Tag List

Usage Pattern
[Function] → [Global Interlock] → Specify the Bit address to be monitored and Touch available condition. → Click <input type="button" value="OK"/> to complete the setting.

The following provides an overview of the Global Interlock setting screen.

**Specify whether to enable/disable the Interlock function.**



**Specify the Bit address to be monitored.**

**Select the condition in which touch operations are enabled.**

■ **Setting the Global Interlock**

The Global Interlock setting procedure is shown below.

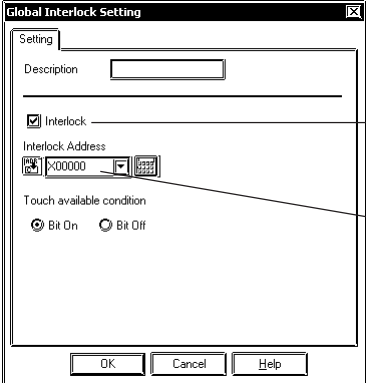
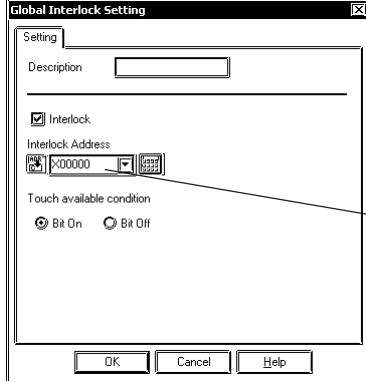
The following sample describes the settings to enable touch operation when X00000 is turned ON.

PROCEDURE	REMARKS
<p>(1) Select the [Function] menu-[Global Interlock] command.</p> <p>(2) Check the Interlock check box and specify the Bit address to be monitored.</p>  <p>(3) Select the desired option from the Touch available condition.</p>  <p>(3) Click on <input type="button" value="OK"/> to confirm the setting.</p> 	

## 2.10 Efficient Drawing Techniques

This section explains how the use of grids, changing display states, and the help function can all help to increase your drawing efficiency.

### 2.10.1 Grid/Snap

Grid Points are placed at regular intervals on your screen and divide the drawing area into a coordinate “grid” pattern; when the Snap to Grid function is enabled, objects that are drawn will automatically “snap” (be aligned) on this “grid” pattern. Use the Grid Point Spacing command to adjust the density of the Grid points, and to display the grid or not. Also, grid points can be displayed as grid lines, not as dots. Grid Points are not shown on the GP unit’s display.

Select the pull down menu [Option]’s [Grid/Snap] command.

#### ■ Grid/Snap Settings dialog box

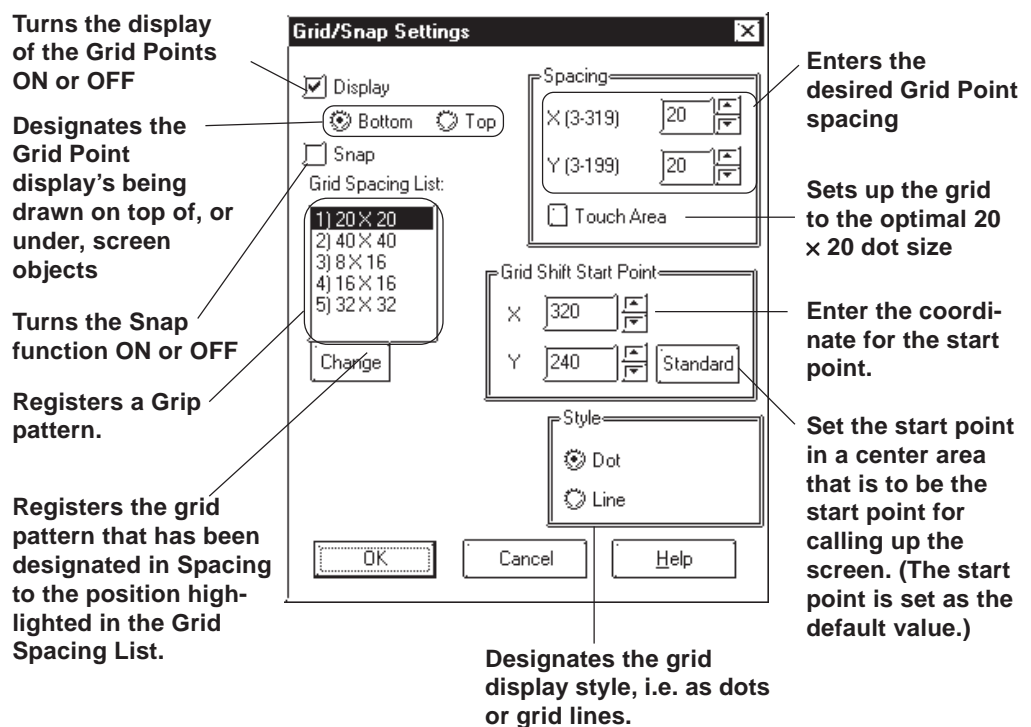

#### ◆ Display

Sets the Grid Point display state (displayed or not displayed).

When the Grid Point's Display is set to "Top", the grid points will be displayed in front of all objects placed on the screen.

Grid pattern display can also be changed in the Grid Tool Bar's grid pattern selection list box.

### ◆ Snap

When the Snap check box is checked, the cursor will “snap” to the grid; objects can only be drawn on points (start & end) along the grid.



**Note:** Turning the Snap function ON or OFF can also be performed via the Grid/Snap Tool Bar's icons  and .

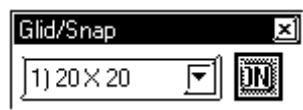

### ◆ Spacing

The Grid Point intervals are entered here. The unit is a dot. Input the interval value for the X and Y axes, respectively. The default value is 20 dots.

When clicking on [Touch Area], a 20 x 20 dot spacing will be automatically designated, which is most suitable for the touch panel.

Select a desired grid pattern in Spacing and click on the  button. Then, the selected grid pattern will be reflected to the current screen and will also be displayed as the 6th selection of the Grid Tool Bar's grid pattern selection list.

### ◆ Grid Spacing List

Clicking on the  button changes Grid Spacing List's highlighted set value to Spacing's set value and registers it.

The grid patterns registered here will be displayed on the Grid Tool Bar's grid pattern selection list box. A grid pattern selected from the grid pattern selection list box will be reflected to the current screen.

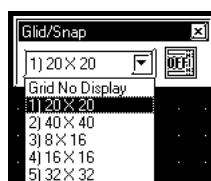

◆ Start Point

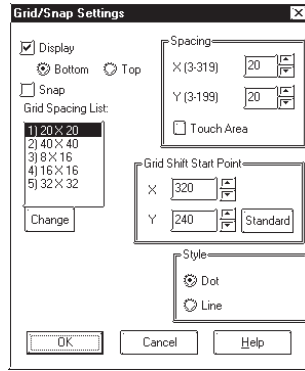

◆ Style

Select grid pattern display style from “Dot” and “Line”.

<When selecting Dot:>

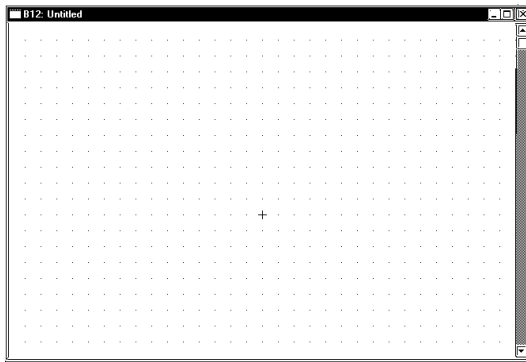

<When selecting Line:>

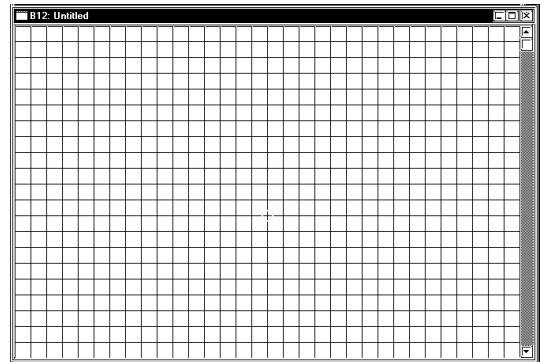

## 2.10.2 Screen Property Settings

Here, the screen display's environment is set up, which effects both the method used to draw screens and displaying the Part and Tag addresses. The user's work environment can be modified whenever necessary, helping to reduce the time required for drawing.

Select the pull down menu [Option]'s [Screen Property] command or click



### ■ Setting Screen Property - [Display]

The display state (displayed or not) of the items such as object Fill, Window Mark, Window Part, Tag Mark, and setting information on Tags and Parts can be selected. Check the box of the items to be displayed. When a box is not checked, that item will not be displayed.

The settings on this screen will be applied to all the screens. Properties cannot be set up for individual screens.

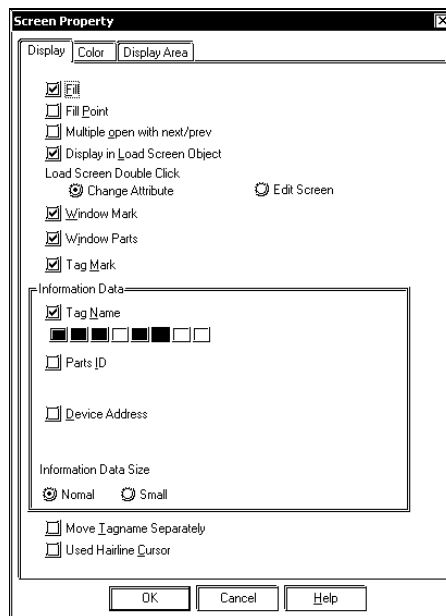

**Note:** The display state of ID numbers, Tag Names, Device Addresses, Tag Marks, and Window Marks can also be changed via the [Option] tool bar icons.



### ◆ Fill

When creating a screen, the drawing can be controlled so that any Fills used will either be displayed or not. If the "Fill" check box is not checked, all Fills are not shown. Using this feature will help you to speed up screen redrawing time, and thus speed up screen creation.



**When the "Fill" check box is not checked, the actual screen shown on the GP unit may differ from the screen shown on your PC. To be sure the display is correct, check the "Fill" check box ON at least once, to verify the screen, before sending screen data to the GP.**



◆ **Fill Point**

When this feature is selected, specified Fill points will appear with an “X” mark, which is especially useful when selecting Fill points.  
If the Fill Points are not displayed, Fill cannot be performed while editing.



**Note:** The X (cursor position) mark's color can be designated in the system's [Color] area.

◆ **Multiple Open with Next/Prev**

When selecting [Previous Screen]/[Next Screen] from the [Screen] menu, or opening a screen with the Open Screen switch , specify whether the next screen is opened with the currently active screen open or after that active screen is closed. Up to 20 screens may be opened continuously.

◆ **Display in Load Screen Object**

You can specify whether tag and part addresses, ID numbers, tag names, and tag marks on a screen which has been called up using the [Load Screen] command are displayed or hidden.

◆ **Load Screen Double Click**

Specify an edit method for editing a screen that has been called up on another screen where the [Load Screen] command was executed, or for editing a screen on the Screen List.

If [Change Attribute] is specified, the Load Screen dialog box will be opened, enabling you to select a screen to be called up (screen number).

If [Edit Screen] is specified, the screen that has been called up will be opened, allowing you to edit the data.

◆ **Window Mark**

Designates the window mark display state, i.e. displayed or not displayed. The window mark shows an area that has been registered as a window.

 **Reference** 3.7 *Window Display: Window(U) Screen and Base(B) Screen*

◆ **Display in Window Part Screen**

Designate whether the contents of the window part placed on the Base screen will be displayed or hidden.

◆ Tag Mark

Designates whether or not the Tag Mark is displayed while a screen is being drawn. Tag Marks show the point or area specified for a Tag. However, a/A/D-tag marks and G/g-tag's Pie/Half-Pie/Meter Tag marks will always be displayed, no matter what this setting is.

<Example>

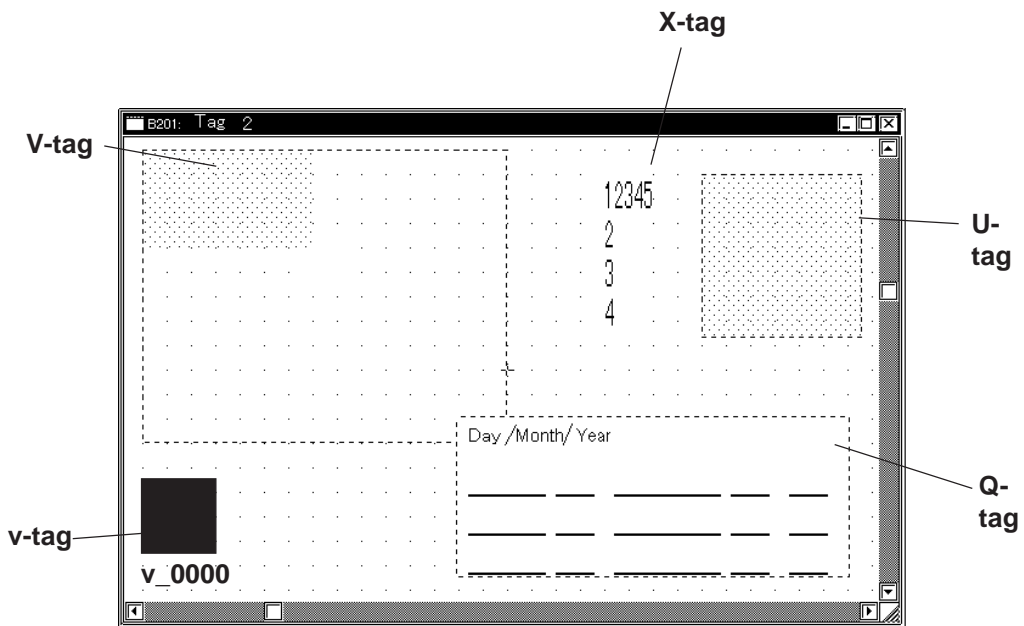
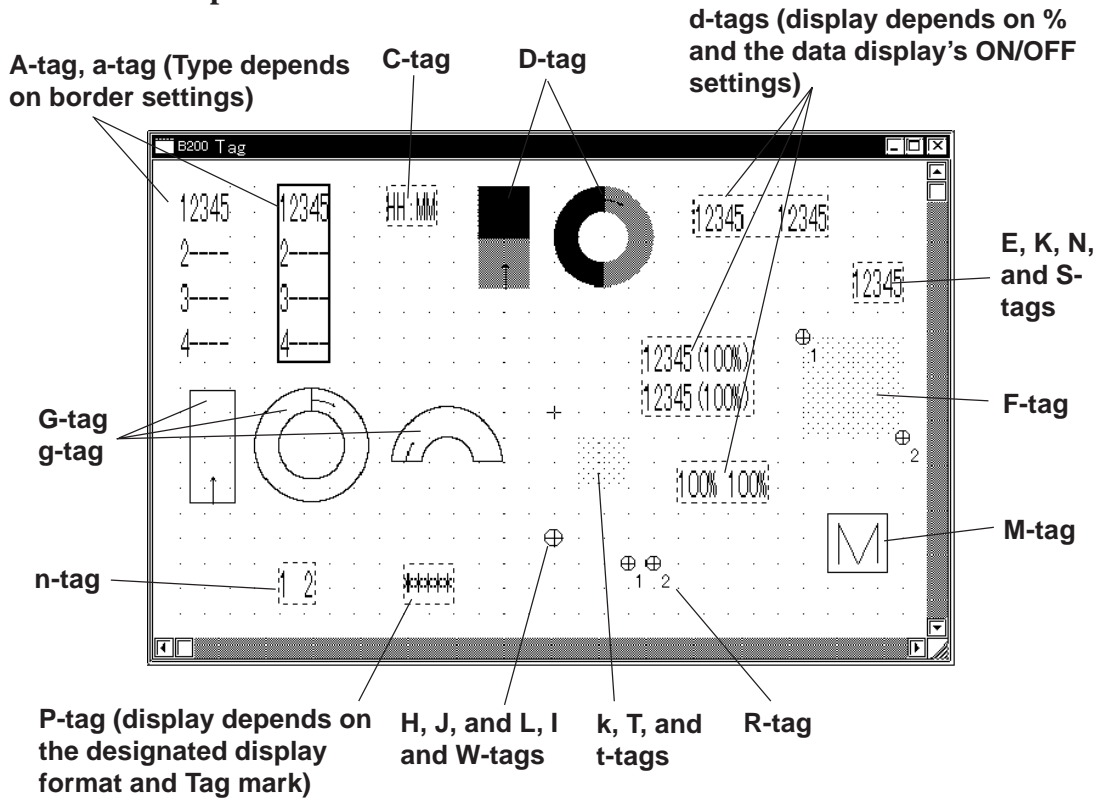

### ◆ Tag Name

Designates whether or not the Tag Name is displayed while a screen is being drawn. Also, display colors can be selected.

### ◆ Parts ID

Designates whether or not a Part's ID number is displayed on the Base screen. Also, display colors can be selected.

### ◆ Device Address

Designates whether or not Part and Tag Addresses are displayed on the Base screen. Part Addresses appear below the ID number, and on Tags, below the Tag Name. Also, display colors can be selected.

### ◆ Information Data Size

Selects the character size displayed from Standard (half size) and Minimized (1/4 size) for ID No., Tag names, and Address.

### ◆ Move Tagname Separately

Whether or not the Tag Name and Address display position is also moved when Tag Marks are moved is designated during screen creation. If this function is selected, when Tag Marks are moved, Tag Names and Addresses will be not moved.

### ◆ Used Hairline Cursor

Changes the arrow cursor to the hairline cursor.

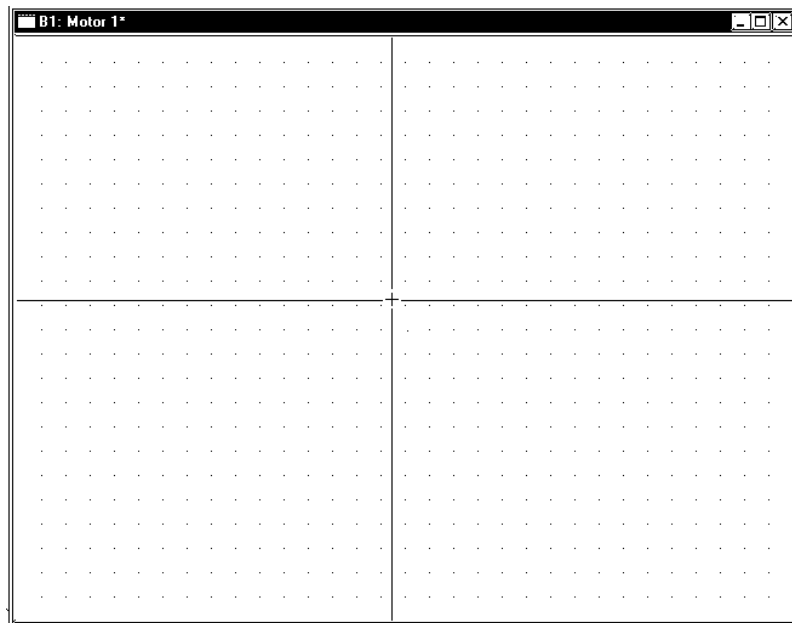

## ■ Setting Screen Property - [Color]

Select the Grid, Fill Point, and Screen Background colors here. When the drawn image data's and system's colors are the same, the screens will be hard to see. Here, these colors can be changed to remedy that.

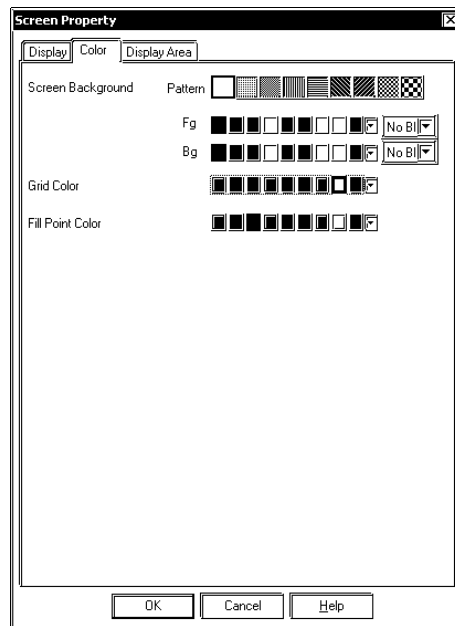

### ◆ Grid Color

Selects the grid point's color.

### ◆ Fill Point Color

Fill Points designate the point where a fill will begin; this setting determines the color of the fill point.

### ◆ Screen Background

Select the Base screen's background color; the color selected here is also displayed on the GP.



- ***If any background color is specified for the screen to be loaded, no on-screen object will be displayed on the GP unit.***
- ***To load a screen whose background color was specified, specify the loading position at the center of the screen.***

■ **Setting Screen Property - [Display Area]**

Select a GP unit with a lower level of resolution than the current one. If the screen display area is different between GP units with different resolution levels, part of the screen may become invalid. With this function, you can confirm the screen area that can be displayed on a different resolution GP unit beforehand.

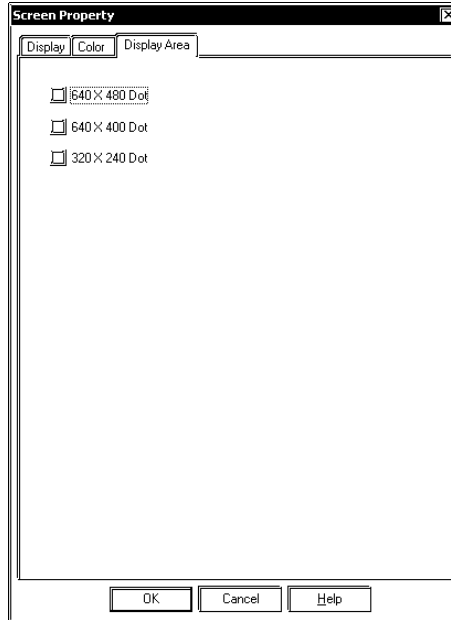

<List of Display Area Resolutions>

Display Area Size	GP Models
640 x 480 dots	GP-570, GP-571, GP-870, GP-577R, GP-2401H, GP-2400, GP-2401, GP-2500, GP-2501
640 x 400 dots	GP-470, GP-477R
320 x 240 dots	GP-H70, GP-270, GP-370, GP-377, GP-377R, GP-2301H, GP-2300, GP-2301

**2.10.3 Preview Screen**

With this feature, you can confirm how an image will appear on the GP unit. This image will differ depending on each GP display device type. Select the [Preview] from the [View].

Select the type of display used

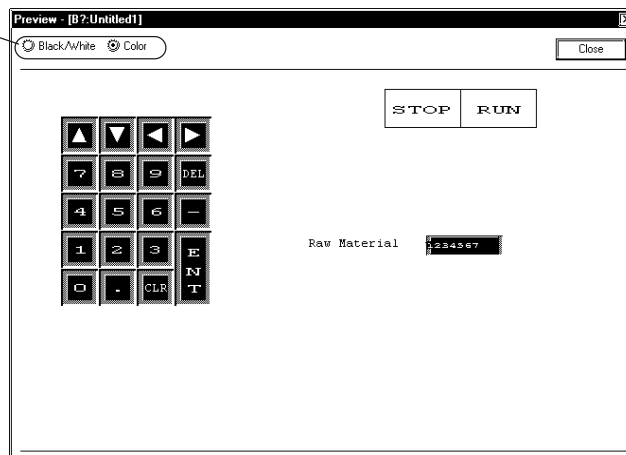

**2.10.4 Screen Data List**

The currently displayed screen’s object locations and setting attributes are listed in the Screen Data List.

**■ Screen Data List**

An example of the Screen Data List is shown below.

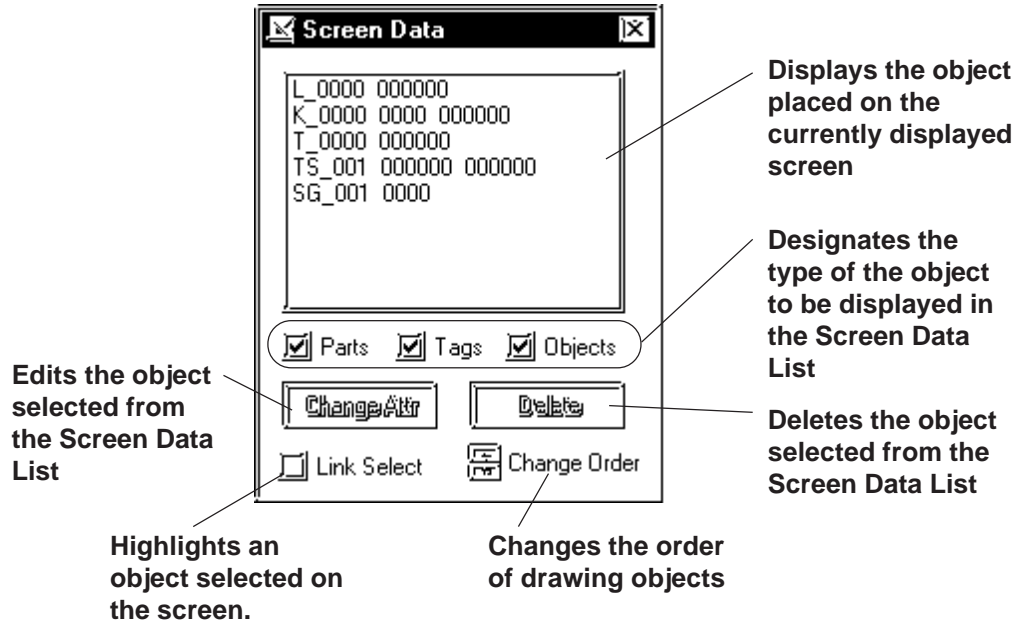

**■ Screen Data Display**

The designated type of object(s) data is displayed. If a grouped object contains at least one object whose type has been designated, it is displayed as an grouped object.

The Screen Data List displays the following information:

- Drawing ..... Type and coordinates of a drawing object
- Tag ..... Tag Name and Address
- Part ..... ID Number and Address
- Grouped object ..... Grouped object’s coordinates and each grouped object’s information



**Note:** D-Scripts are displayed as tags. Each D-Script shows ID and description information.

**■ Selecting an Object**

The object selected from the list will be displayed with handles (i.e. selected) in the Screen Editor. To select multiple objects from the list, Left-drag them, or hold the [Shift] or [Ctrl] key down and click on desired ones.

**◆ Link Select**

Normally, when any object is selected with the Screen Editor, it will not be displayed on the list. If the check box for [Link Select] is marked, an object selected with the Screen Editor will also be selected (highlighted) on the list.

### ■ Editing an Object

To edit an object, select it from the list and click on the  button; or simply double-click on the object.

If the object is D-Script, D-Script Editor will be actuated.

Clicking on the  button deletes the selected object.

### ◆ Change Order

Objects are displayed on the list in the order where they have been drawn. If the order of objects on the list is changed, the overlapping order of drawn objects and the executing order of tags and parts can also be changed.

### ◆ Copying

Any object on the list can be copied by pressing the  + , or pasted by pressing the  +  keys. Multiple objects can be copied at a time by selecting them.

**2.10.5 Part Reference List**

The settings for each Part placed on the currently edited screen are listed here, for each Part type. Part settings can also be changed on the Part Reference List.

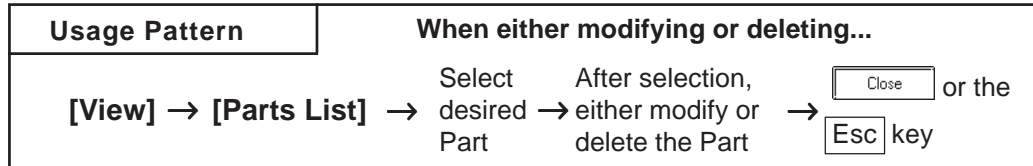

An example of the Part Reference List on a screen is shown below.

**Reflection of device comment**  
The device comment corresponding to an entered device address overwrites the Description field.

**Shows a list of the Parts on the currently selected screen. Simply click on the desired Part**

**Changes Part's settings**

**Deletes the selected Part**

**Copies a part**

**Pastes a part**

**Stores the Parts list information as a CSV file.**

**Use this scroll bar to view all the data on a long screen**

**Closes the current screen. (The  key can also be used)**

Part ID	Description	Data Address	Display M.	Data Format	Bk Length	Input Code	Min. Value	Max. Value	Edit
1	BA_001	Run Test	000000	+					
2	BA_002	Run Test	000000						
3	BA_003	Run Test	000000						



**Note:** The tab width for each item can be adjusted by placing the mouse pointer on the border between items and then dragging it.

**■ Editing Items on the Part Reference List**

Part setting data can be changed directly on the Part Reference List. Click on the left-most number of a Part to be changed, and it will be highlighted; then, click on the  button, and the Part's Dialog box will appear and its settings can be changed. Setting items, such as the Description and Address areas, can be changed via the Part Reference List. Also, items displayed in gray can be changed in the dialog box by double-clicking on the inside of their border.

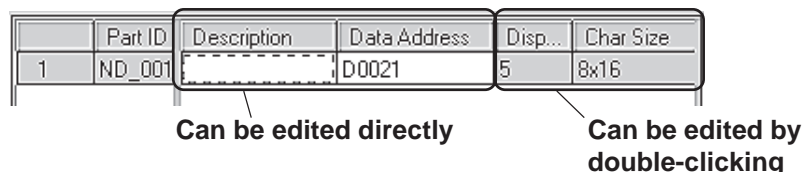





**Note:** For the labels and messages of more than one line, use “\” as the carriage return.

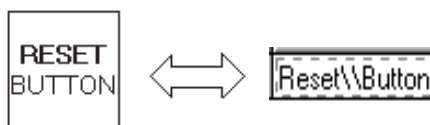

### ■ Deleting Items from the Part Reference List

Parts can be deleted directly from the Part Reference List.

Click in the middle of a Part to be deleted, and it will be highlighted. Then, click on the  button, and a dialog box will appear. Clicking on the  button will delete the Part from the Part Reference List. To close the box without deleting the Part, click on the  button. When multiple Parts are selected, all the Parts will be deleted by clicking on the  button, and by clicking on the  button, the box will be closed.

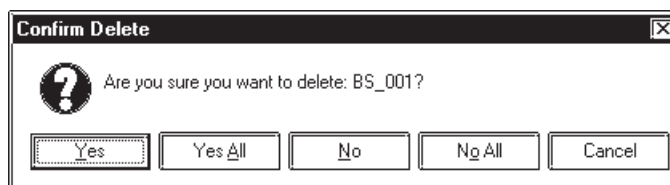

### ■ Copying a Part on the Parts List

Any part can be copied on the parts list.

Select the left-most number for the part being copied by clicking on that number. The selected part will be highlighted. After this selection, click on the  button and then the  button. The part will be copied to the bottom line of the list.

### ■ Reflecting a Device Comment on the Parts List

The device comment corresponding to an entered device address can be entered on the parts list by clicking on a specified button. This can be done in either of the following two ways:

1. Select the address setting field and click on the [Apply Device Comment] button.

The device comment corresponding to the selected address will be reflected in the Description field.

2. Select a part by its line and click on the [Apply Device Comment] button.

If there are multiple address setting items for that part, the description corresponding to the address specified in the [Address Table for Automatic Input of Device comment] will be reflected in the Description field.

#### ▼ Reference 2.4.7 ◆ Reflection of Device Comments

■ Exporting a CSV File

The Parts list information can be saved as a CSV file.

You can also select whether the currently selected page (tab)'s information will be exported or the entire page will be exported.

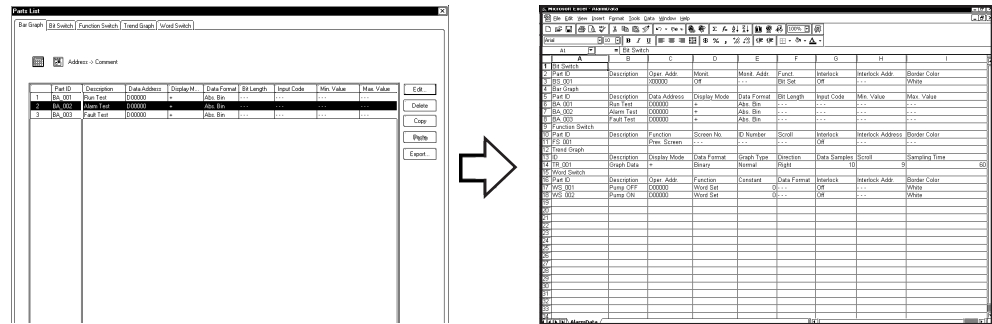

**2.10.6 Tag List**

Tags and their setting attributes (type of data) specified on the current screen or in a Project File can be listed; the setting attributes can also be changed on the Tag List. The Tag List will be displayed separately for Local Setting (Tags specified for each screen) and for Data Sampling Settings specified commonly for all the screens. When using a Handy-type GP (GP-H70/ GP2000H series) unit, the Global function keys will also be displayed. When using an ST Series unit, the setting for Backlight Color Change will also be displayed. The Tag List for Local Setting and Tag data setup for each screen will be displayed.

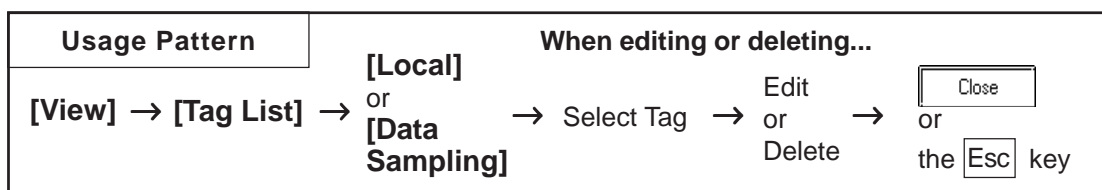

The following is the Tag list (local) screen example.

The edit method of this list is the same as that of the Parts list.

**Reference** 2.10.5 Part Reference List

**Lists all the Tags used on the currently open screen. Select the desired Tag to list its type of data**

**Opens the selected Tag for editing**

**Deletes the selected Tag**

**Copies Tag**

**Pastes Tag**

**Moves Tag one position higher on the list**

**Moves Tag one position lower on the list**

**Using Device Comment**  
Here, the device comment that corresponds to an device address is automatically written in the Description field.

**Click on Close to close the Tag List screen. Pressing the [Esc] key will also close the screen**

**If Tag has been grouped, an asterisk will appear here.**

Tag ...	Description	Grouped	Edit
1 A_0001	Alarm Summary		
2 C_0001	Time Summary		
3 B_0001	Pump ON		
4 n_0001	Motor Test		

**Reference** 2.4.12 Group/Ungroup

## &lt;Individual Tag List Screen&gt;

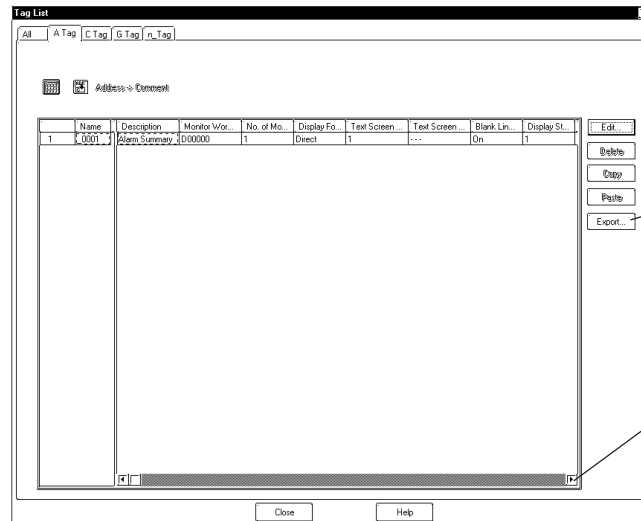

Saves the Tag List in a CSV file

Scrolls the display left, right, up and down when the Tag List is bigger than the screen size



- Note:**
- The tab width for each item can be adjusted by positioning the mouse pointer on the border between items and then dragging it.
  - For Handy-type GP (GP-H70/GP2000H Series) unit, the Tag names specified via the Local function keys will become “OP\_ \* \_\*\*\*\*” or “F\_ \* \_\*\*\*\*”, thereby allowing you to distinguish in the Tag List whether the Tag was set up via the Local function keys or on the screen.

**Reference** 2.11.1 Function Keys

### ■ Changing the Tag Setting Order

The Tags will function in the order that they have been set up (the order displayed on all the pages of the Tag List) on the GP screen. To change this order, click on either the **Move Up** or **Move Down** key. When multiple Tags are grouped, that group will be moved up or down.

### ■ Exporting a CSV File

The Parts list information can be saved as a CSV file.

You can also select whether the currently selected page (tab)’s information will be exported or the entire page will be exported.

**Reference** 2.10.5 Part Reference List ■ Exporting a CSV File

**2.10.7 Cross Reference List**

The Cross Reference List feature is useful when displaying the current address condition of Tags and other items. Here, the exact address used for each Tag can be checked.

Cross reference will be displayed for local settings (each screen's Tags, D-scripts, and Parts), and data sampling and global D-scripts registered for all the screens. If you use the Handy-type GP (GP-H70/GP2000H Series) unit, the global function key settings will also be displayed.

When using an ST Series unit, the setting for Backlight Color Change will also be displayed.

The Global Cross Reference List feature does not sort the settings by function and screen; it displays the current address conditions of the entire Project file (including the GP system) in a list.



- Since, to display the global cross reference, address information for all the screen will be acquired, it can take a long period of time.
- The global cross reference does not display the condition of addresses that have been designated via [GP System Settings].
- After changing the GP model (GP type), addresses specific to the previous GP model (type) may be displayed. (For example, when changing GP-H70/ GP2000H Series to the other model, this may occur.)

**■ Cross Reference (Local, Data Sampling, Global D-script)**

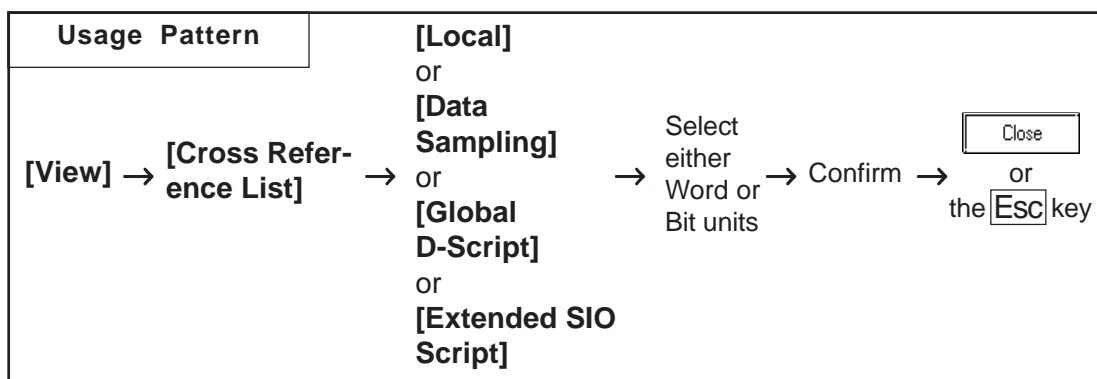

An example of the Cross Reference List dialog box (in the case of Local) is as shown below.

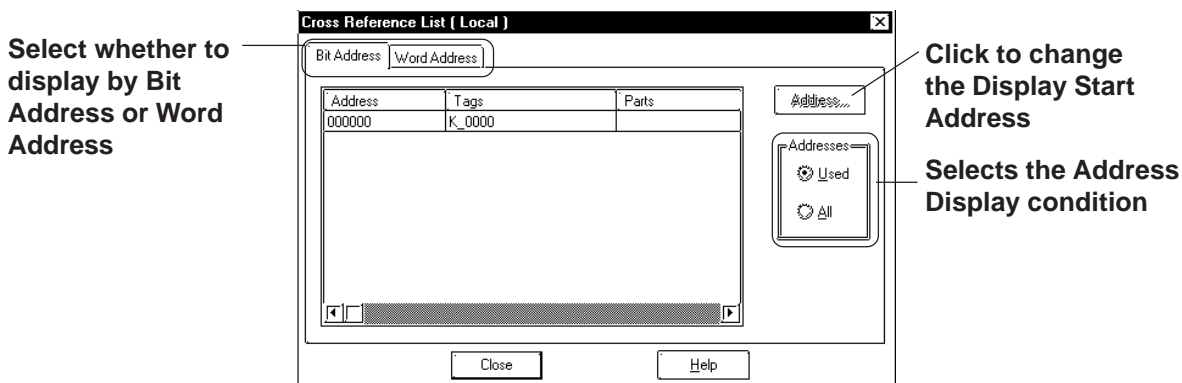

■ Global Cross Reference

The global cross reference has two display methods, i.e. list display same as the standard cross reference and address map display. This feature enables you to go to the screen that uses the address you want to edit, to convert addresses in one operation, and to make a reference to an address.



- Limitations exist regarding the display of the following addresses with the global cross reference that was designated when the GP System was set up. (To set up the GP system settings, select **GP Setup** from the Project Manager menu, and configure the settings in the [GP System Settings] dialog box.)
- The "Alarm Trigger Count Write's Start Address" designated in the [Q-Tag Setting] dialog box on the [Extended Settings] tab (by clicking on the **Q Tag Settings...** button) is not displayed.
- The [Watch Dog] address designated on the [Extended Settings] tab will not be displayed when the "Time" is set to "0" seconds.
- As for the [System Start Address] designated on the [Mode Settings] tab, only the designated System Start Address will be displayed regardless of the total number of words used in the system area and the reading area size.

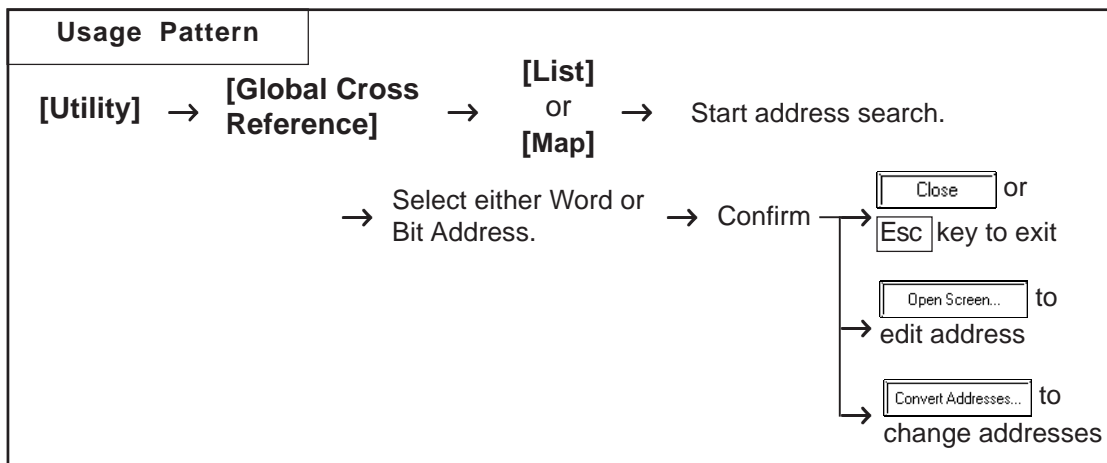

The following is the overview for the global cross reference screens.

◆ **List Display**

For local settings, which screen is used, and for global settings, function type will be displayed, respectively.

**Selects whether setting conditions are displayed for Bit Addresses or for Word Addresses.**

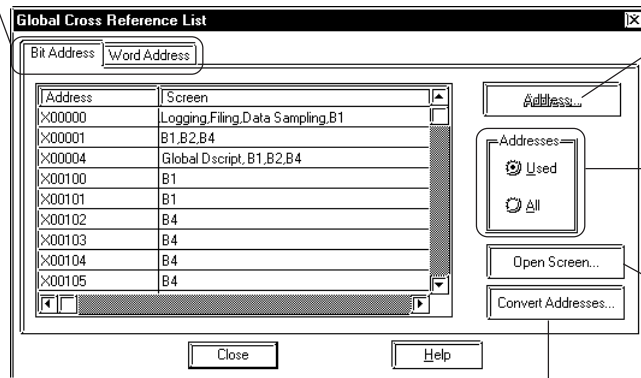

Changes the display start address to be displayed.

Selects the range of Addresses to be displayed.

Click to select the screen in which the address you want to edit is used, or go directly to the desired screen.

Click to convert the addresses in one operation. **Reference 4.2.4**  
*Converting Addresses and Device Codes*

◆ **Address Map Display**

When selecting Word Address, the table cells from Word Address Bits 0 to 15 (for 32 bit device, from 0 to 32) will all be filled. When selecting Bit Address, only bit cells currently used will be filled.

Selects whether setting conditions are displayed for Bit Addresses or for Word Addresses.

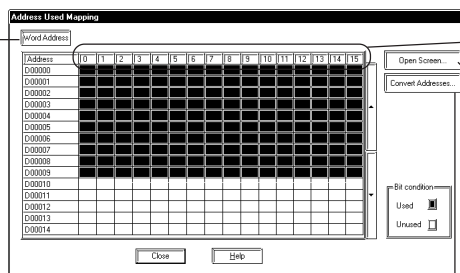

Displays the Bit location.

Click to select the screen in which the address you want to edit is used, or go directly to the desired screen.

Click to convert the addresses in one operation. **Reference 4.2.4**  
*Converting Addresses and Device Codes*

◆ **Changing Addresses**

You may move to the drawing screen of the specified address from the global cross reference, or change addresses.

On the global cross reference list, double-click on the column of the address you wish to change. Or, click on the  button to open the [Start Address] dialog box, specify the address before the change, and click on the  button.

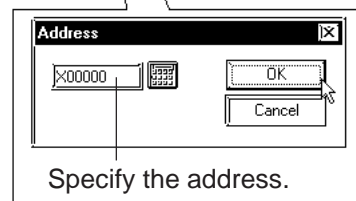
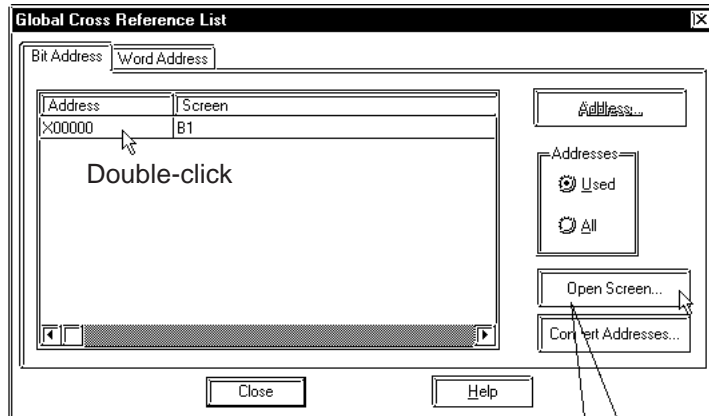

**Note:** When selecting an address designated on the Base screen, Trend Graph screen, Keypad screen, Video screen or Window screen, open the screen by double-clicking on the address or by clicking on the  button after selecting the desired address.

When the specified address is used only on one screen, the screen will be displayed directly. When the specified address is used on two or more screens, the [Open Screen] dialog box appears. Select the desired screen (two or more screens can be selected) and click on the  button.

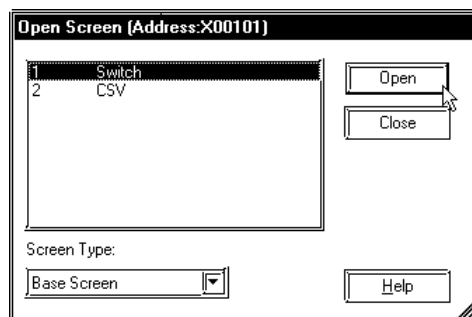

The Global Cross Reference dialog box closes when the drawing screen opens.



### ◆ Address Block Conversion

The addresses listed on the Global Cross Reference dialog box (all addresses in the Project and GP system addresses, excluding the addresses registered as symbols) can be converted into different addresses in one operation simply by clicking on the  button.

#### ▼ **Reference** 4.2.4 Converting Addresses and Device Codes

The Global Cross Reference display is automatically updated after the Address Block Conversion operation.



- Among the tags and parts, the ones corresponding to both bit addresses and word addresses are cross-referenced with both of those addresses on the Cross Reference List even if they were placed by specifying their bit addresses.

**Example:** A tag (part) placed at bit address, X0000F is displayed as word address, X00000.

- In the case of the Handy-type GP (GP-H70/GP2000H Series) unit, tag names on the setting list can be used to distinguish tags added with local function keys from ones added on screens. The tags added with local function keys are named as “OP\_ \*\_\*\*” or “F\*\_\*\_\*\*”.

#### ▼ **Reference** 2.11.1 Function Keys

### ■ Changing Display Addresses

When [Used] is selected on the cross reference or global cross reference list display, the addresses that have been used for the Tags, Parts, and Extended SIO Scripts in the currently opened screen or Project (including the GP system) are displayed. When selecting “All Addresses”, all the addresses beginning with the Start Address will be displayed. To change the Start Address, click on the  button, and the Dialog box shown below will appear. Set the Start Address and click on the  button, and the display will show from that address on.

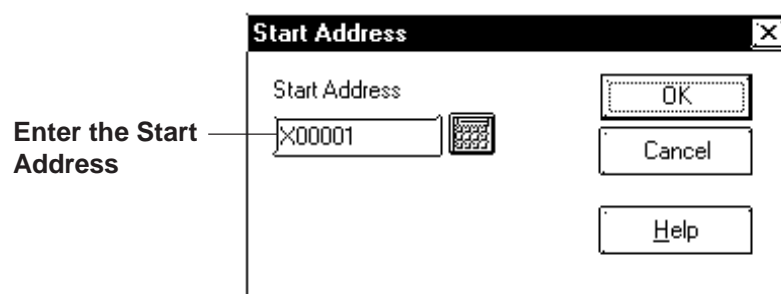

For the global cross reference's address map display, the map display start address can be designated when toggling Bit and Word display.

When clicking on  or , the following dialog box will appear. After selecting Bit or Word, designate the start address. Then, click on the  button and the cross reference display will start from the designated start address.

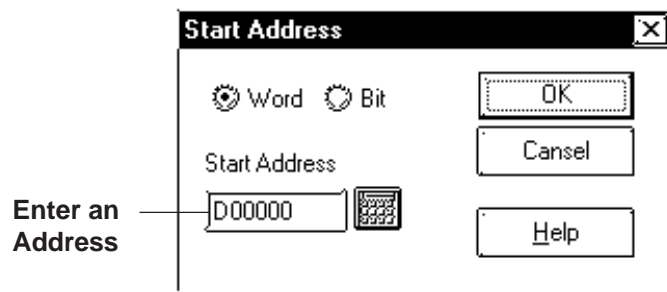

**2.10.8 Load Screen List**

The Load Screen List will be displayed on the currently edited screen. With this list, you can check the setting attributes of a screen to be loaded and also can change its loading location.

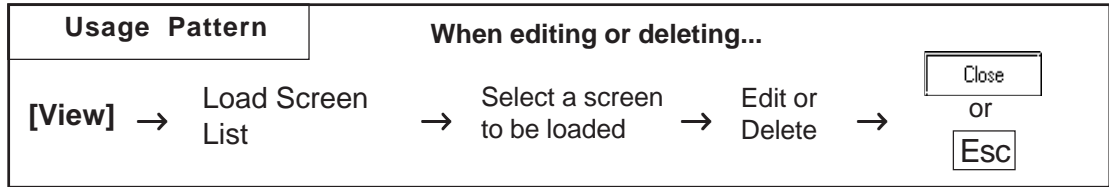

General Load Screen Summary List

Lists all the screens loaded on the currently open screen. Select the desired screen to show its setting attributes.

Click on to close the Load Screen List screen. Pressing the  key will also close the screen

Changes Load Screen List Settings

Deletes a Load Screen List

Scr...	Position X	Position Y	Title
1 2	135	59	Line A
2 3	305	81	Statistics A
3 4	265	182	Alarm A

■ **Editing via the Load Screen List**

Screen settings can be changed using the Load Screen List. Clicking on the left-most number of a screen to be changed will select (highlight) it. Then, clicking on the [Edit] button will bring up the [Load Screen] dialog box or the currently called-up screen, allowing you to edit the screen. The procedure for calling up and then editing a screen varies depending on the settings in the [Load Screen Double Click].

▼ **Reference** 2.10.2 ■ *Setting Screen Property - [Display]*

Any coordinate setting can be changed directly via the Load Screen List.

### ■ Deleting from the Load Screen List

Screens can be deleted from the Load Screen List.

Clicking on the left-most number of a screen to be changed will select (highlight) it. To delete multiple Load Screen Lists simultaneously, simply drag the cursor to select the screen numbers. Then, click on the  button, and the dialog box will appear to confirm the command. If you click on  button, the screen will be deleted. To cancel the request, click on the  button. When selecting multiple screens, click on the  to delete all of them, and click on  to cancel any deletions.

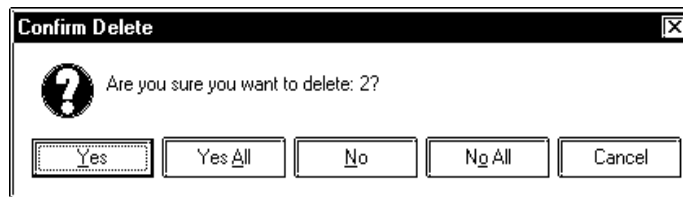

**2.10.9 Display of Screen Level Change Structure**

The nesting of Load Screens that have been set up on the currently edited screen is displayed. In this way, a multiple nesting condition can be viewed.

**Reference** 2.2.10 Load Screens ■ Nesting

Select the [View] menu - [Load Screen Nesting Display] command.

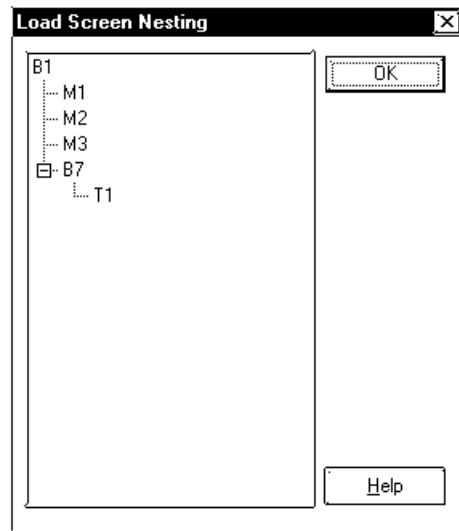

Each screen will be displayed via the following symbols:

Screen Type	Symbol
Base screen	B
Mark screen	M
Trend Graph screen	T
Keypad screen	K
Image screen	I
Image screen - CF card	I(CF)
Window screen	U

## 2.11 Creating Handy-type GP Screen

The following screens are for the GP-H70/GP2301H and GP2401H units.

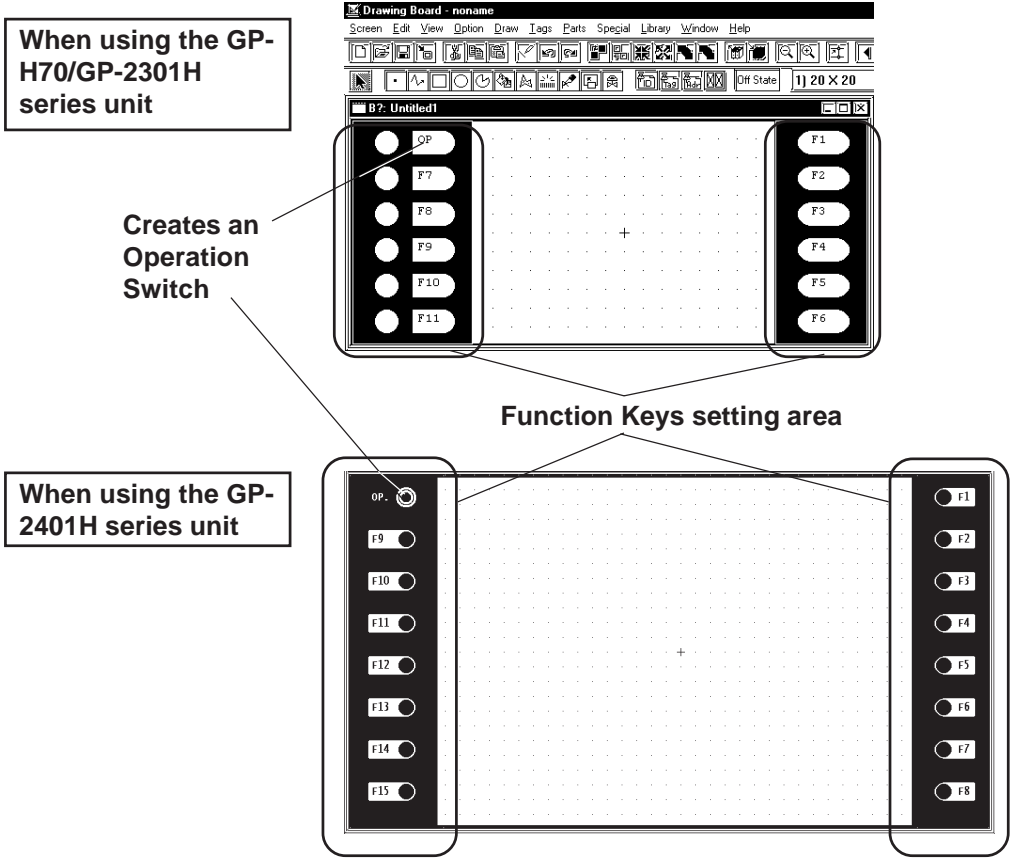

### 2.11.1 Function Keys

There are Function Keys on each side and you can set up each one as a Tag (T-tag, t-tag, k-tag) for touch input. GP-H70/GP-2301H series has six Function Keys and GP-2401H series has eight keys on each side.

These Function Keys can be specified for Local Use or Global Use. With the Local Function Key Setup, the Function Keys can only be used by the designated screen. With the Global Function Key Setup, the Function Keys can be commonly used by all screens.

The number of Tags that can be registered on a GP panel as Global Function Keys is limited to a total of 24 T, t and k-tags.

The following Tags together with other Tags designated on the screen can be used for a single screen's Local Function Keys (except the Tags designated for Function Keys).

GP-H70 series :128

GP2000H series :384

Registering a single t-tag as a Global Function Key, however, requires 2 Tags.

If a Function Key is set up for both Global and Local use, then the Tags specified as Global will be performed first.

All Tags registered as Function Keys cannot use the AUX output or Reverse Video features.

#### ■ Function Key Settings

An example of the Function Key Setting screen is shown below.

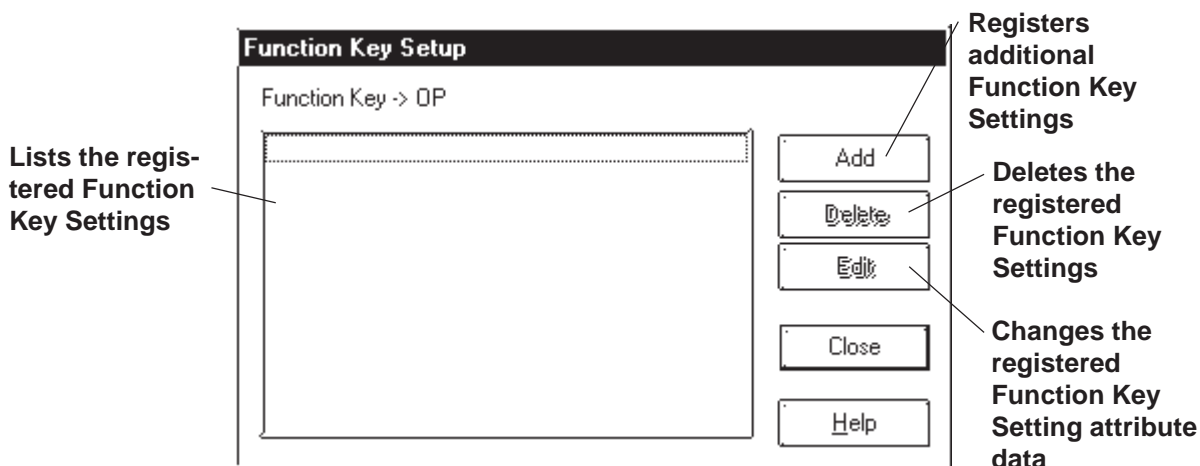

### ■ Setting Up Local Function Keys

The Local Function Key Setting procedure is described. An example of using the GPH70L/GPH70S/GP2301HL/GP2301HS is as follows.

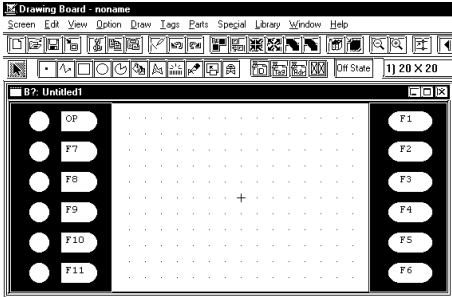
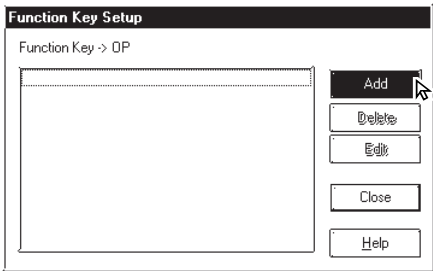
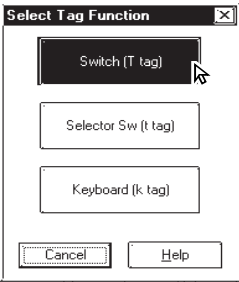
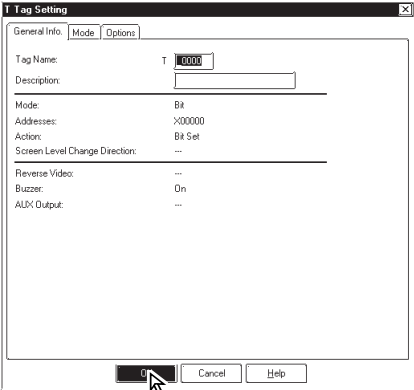
PROCEDURE	REMARKS
<p><b>(1) Double-click on any of the Function Keys displayed.</b></p> 	<p>When using the GP-2401H series unit, there are eight Function Keys including the Operation switch on each side.</p>
<p>When using the GPH70L/GPH70S/GP2301HL/GP2301HS series</p> <p><b>(2) Click on the [Function Key Settings] screen's</b></p> <p><b>Add</b> button.</p> 	
<p><b>(3) Click on the Tag Name to be used.</b></p> 	<p>Multiple Tags can be assigned to a Function Key; however, there is a limit to the number that can be used.</p>
<p><b>(4) Enter the Tag setting data. After all the attributes have been entered, click on the</b> <b>OK</b> <b>button to register the entered data.</b></p> 	<p><b>Reference</b> For details of each Tag's setting data, refer to <i>Tag Reference Manual, Chapter 2 Active Image Functions.</i></p>

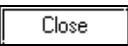
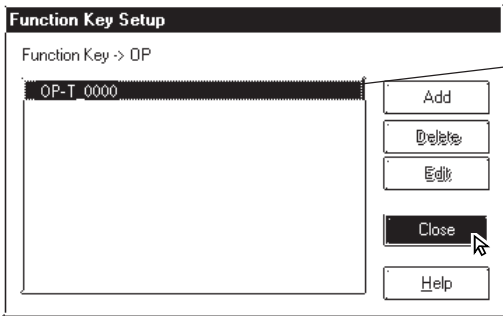

PROCEDURE	REMARKS
<p>(5) Click on the  button to quit the Function Key registration.</p>  <p>Displays the registered item</p>	<p>To register another item, DO NOT quit here, rather start again from step (2).</p>

**■ Setting Up Global Function Keys**

The Global Function Key Setting procedure is described. An example of using the GP-H70/GP-2301H series is as follows.

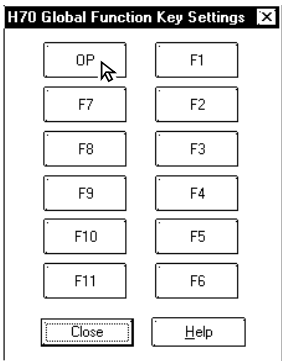
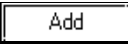
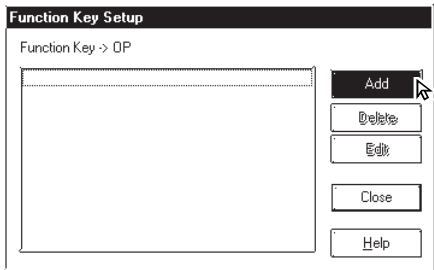
PROCEDURE	REMARKS
<p>(1) Click on the [Special] menu's [Global Fn Key].</p> <p>(2) Double-click on any of the Function Keys displayed.</p>  <p>When using the GP-H70/GP-2301H series</p> <p>(3) Click on the  button.</p> 	<p>Before this selection, open any Base screen.</p> <p>When using the GP-2401H series unit, there are eight Function Keys including the Operation switch on each side .</p>

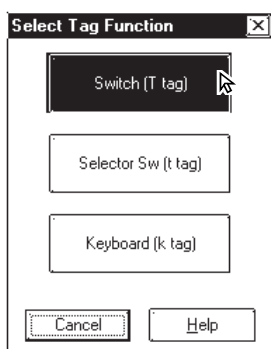
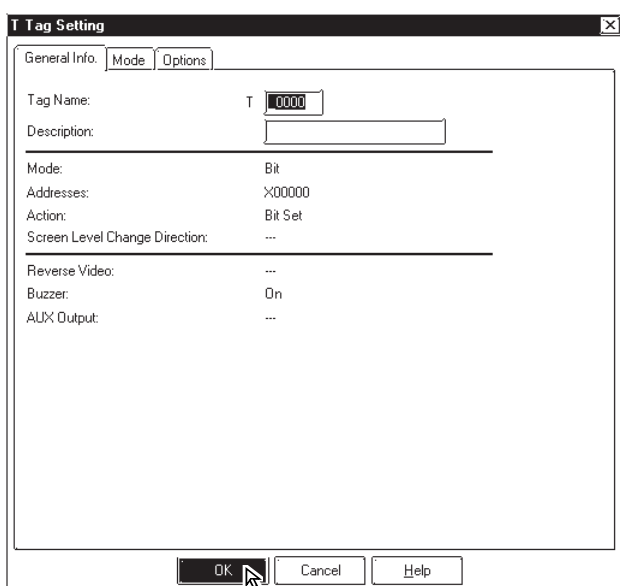
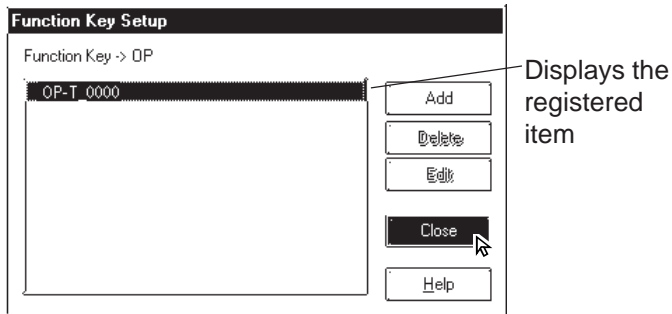
PROCEDURE	REMARKS
<p>(4)Click on the Tag Name to be used.</p>  <p>(5)Enter the Tag setting data. After all the attributes have been entered, click on the <input type="button" value="OK"/> button to register the entered data.</p>  <p>(6)Click on the <input type="button" value="Close"/> button to quit the Function Key registration.</p> 	<p>Multiple Tags can be assigned to a Function Key, however, there is a limit to the maximum number.</p> <p>▼ <b>Reference</b> ▲ For details of each Tag's setting data, refer to <i>Tag Reference Manual Chapter 2 Active Image Function</i>.</p> <p>To perform the registration continuously, DO NOT quit here, start from step (3) again.</p>

■ Notes for the Function Keys

If changing your GP type from GP-2401H series (16 Function Keys) to GP-H70/GP-2301H series (12 Function Keys)/ST series (6 Function Keys) or vice versa, some keys may be shifted from the designated place due to the difference of Function Keys.

**2.11.2 Setting Up the Operation Switch**

This section describes the procedures for setting up the Operation Switches supported by the GP-H70/GP2000H series.

The features of the Operation Switch are as follows:

- (1) An Operation Switch can be used as a Function Switch.
- (2) An Operation Switch can be used to enable Inputs from the touch panel and Function Keys.

For details of feature (1), see the setup procedures in Section 2.9.1 "Function Keys."

Feature (2) is activated only when the Operation Switch is enabled. The procedure for enabling the Operation Switches is described below. If the Operation Switches are disabled, only feature (1) is available.



**When using a Front Face Operation Switch for use of Feature (2), select [2 Point Touch] in the [Touch Input Mode] setting in a GP's [INITIALIZE] menu (OFF-LINE mode) or the [I/O Settings] tab in the [GP Settings] dialog box. If the [2 Point Touch] is not selected, Inputs from the touch panel and Function Keys are not enabled even with the Front Face Operation Switch pushed.**

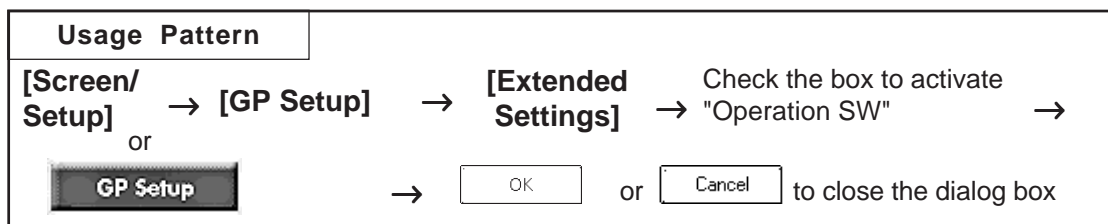

• The function of the Operation Switch can be "enabled" or "disabled" in the GP's INITIALIZE menu (OFF-LINE mode). Refer to GP-H70 Series User's Manual/GP2000H Series User's Manual.

■ **Setting Up the Operation Switches with the GP-H70**

◆ **The Position of the switches**

The GP-H70 has two Operation Switches; one on the front face and one on the rear face.

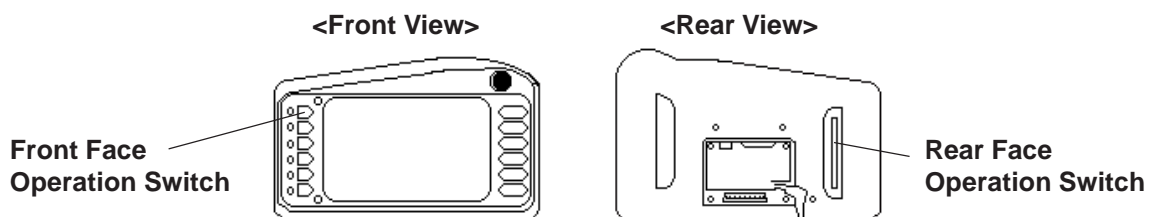

◆ **Default Settings of the switches**

According to the default settings of the GP-H70, both Operation Switches are enabled with the dialog box below.

The "Operation SW" is checked by default.

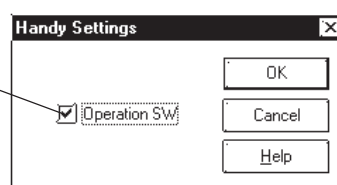



- If the Operation Switches are enabled, do not hold down both the front Operation Switch and rear Operation Switch simultaneously when performing touch input. Doing so disables touch input. Make touch input while holding down only one of the switches.

## ■ Setting Up the Operation Switches with the GP2000H

### ◆ Positions of the switches

The GP2000H has one Operation Switch on the front.

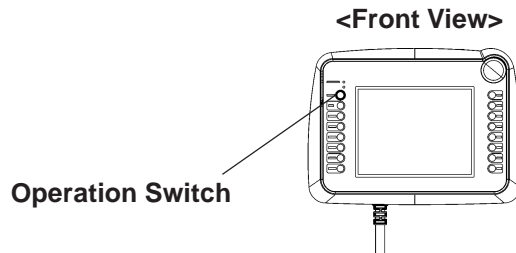

### ◆ Default Setting of the switch

According to the default settings of the GP2000H, the Operation Switch is disabled. When the GP is operated under the default settings, the inputs from the touch panel and Function Keys are enabled.

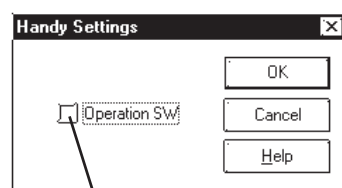

The "Operation SW" is unchecked by default



- The GP2000H and the GP-H70 differ in the number of Operation Switches and the default settings of the switches. Note this difference when switching from the GP-H70 series to the GP2000H model.

## ■ Settings for Using the GP2000H Series in GP-H70 Standard Mode

This setting allows you to use the switch located on the rear of the GP2000H series as an Operation Switch. Change the hardware settings of the GP2000H and select "GP-H70 Standard Mode."

**Reference** For detailed procedures on setting up the hardware, refer to *the GP2000H Series User's Manual*.

To ensure that inputs from the touch panel and Function Keys are entered only when the Operation Switches are being pressed, change the default setting and select the "Enable" setting option of the Operation Switch.



The switch located on the rear of the GP2000H can be pressed down in two positions. Pressing down the switch firmly to the second position disables the touch inputs. Be sure to press down the switch to the first position only.

**2.11.3 Vibration Function**

This function activates the internal motor of the GP to generate a vibration. This is a global function for all screens. Up to sixteen Global Vibration settings can be set up within a single Project File.

*Note:* · Only the GP2000H series supports the Vibration Function.

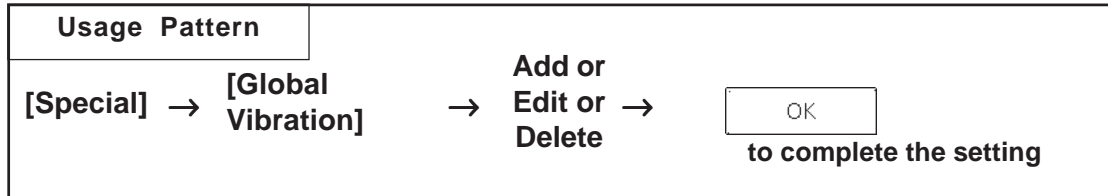

Below is a brief description of the Global Vibration Screen.

The screenshot shows a window titled "Global Vibration\*" with a list of registered vibrations and a vertical toolbar on the right. Callouts provide the following descriptions:

- Displays the Monitor Address and Descriptions of the registered Global Vibration settings in a list.** (Points to the list table)
- Register a new Global Vibration.** (Points to the "Add" button)
- Modify the settings of Global Vibration.** (Points to the "Edit" button)
- Copy a Global Vibration.** (Points to the "Copy" button)
- Paste the Global Vibration that was copied.** (Points to the "Paste" button)
- Delete the registered Global Vibration.** (Points to the "Delete" button)

Address	Description
X00000	X00000
X00000	D00000

### ■ Setting Up Global Vibration with the Bit Address

This section briefly describes the Global Vibration Screen when the "Bit Address" is being designated for the monitoring function.

The screenshot shows the 'Global Vibration Setting' dialog box with the following fields and options:

- Description:** A text input field.
- Bit/Word:** Radio buttons for 'Bit' (selected) and 'Word'.
- Bit address:** A numeric input field showing 'X00000' and a keypad icon.
- Trigger:** Radio buttons for '0->1' (selected) and '1->0'.
- Vibration pattern:** Radio buttons for 'Continuous' (selected) and 'Interval'.
- Vibration time(Auto off time):** A numeric input field showing '10' and a keypad icon.
- Buzz:** A checkbox that is currently unchecked.
- Buttons:** 'OK', 'Cancel', and 'Help' at the bottom.

Callout annotations point to the following elements:

- 'Select the address to be monitored.' points to the Bit/Word radio buttons.
- 'Enter the bit address for activating the vibration.' points to the Bit address input field.
- 'Enter the vibration conditions.' points to the Trigger radio buttons.
- 'Select the operation mode for the vibration.' points to the Vibration pattern radio buttons.
- 'Enter a description as necessary.' points to the Description input field.
- 'Designate the duration of the vibration. (Available range: 1 to 60 seconds)' points to the Vibration time input field.
- 'Enable/Disable the buzzer.' points to the Buzz checkbox.

#### ◆ Mode

Select either the Bit Address or Word Address for the device to be monitored.

#### ◆ Address

Enter the Bit Address used to trigger the Global Vibration here.

#### ◆ Trigger Type

Designate the condition that triggers the vibration. Select "0 to 1" to trigger the vibration when the bit makes the 0-to-1 transition; select "1 to 0" for the opposite condition.

#### ◆ Vibration Pattern

Select either Continuous or Interval mode for the vibration pattern.

- Continuous: The vibration continues for the period specified under the "Vibration time" option without interruption.
- Interval: The vibration repeatedly activates for 0.5 seconds followed by a 0.5 second pause for the period specified in the "Vibration time" option.

**Example:**  
Vibration time: 3 seconds

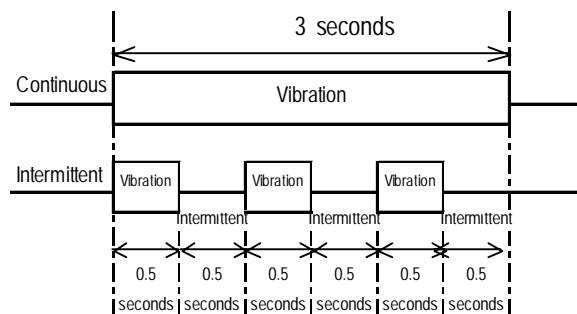

#### ◆ **Vibration time (Auto OFF time)**

Specifies the duration of time after the vibration has been triggered.

The available range is from 1 to 60 seconds. The default setting is 10 seconds.

#### ◆ **Buzzer**

When this option is enabled, the buzzer sounds according to the selected Vibration Pattern.

The buzzer will not sound if "Touch Buzzer Sound" is disabled in [System Setup] under the Project Manager's  window, even when the "Buzzer" function is enabled here.

■ **Setting Up Global Vibration with the Word Address**

This section briefly describes the Global Vibration Screen when the "Word Address" is being designated for the monitoring function.

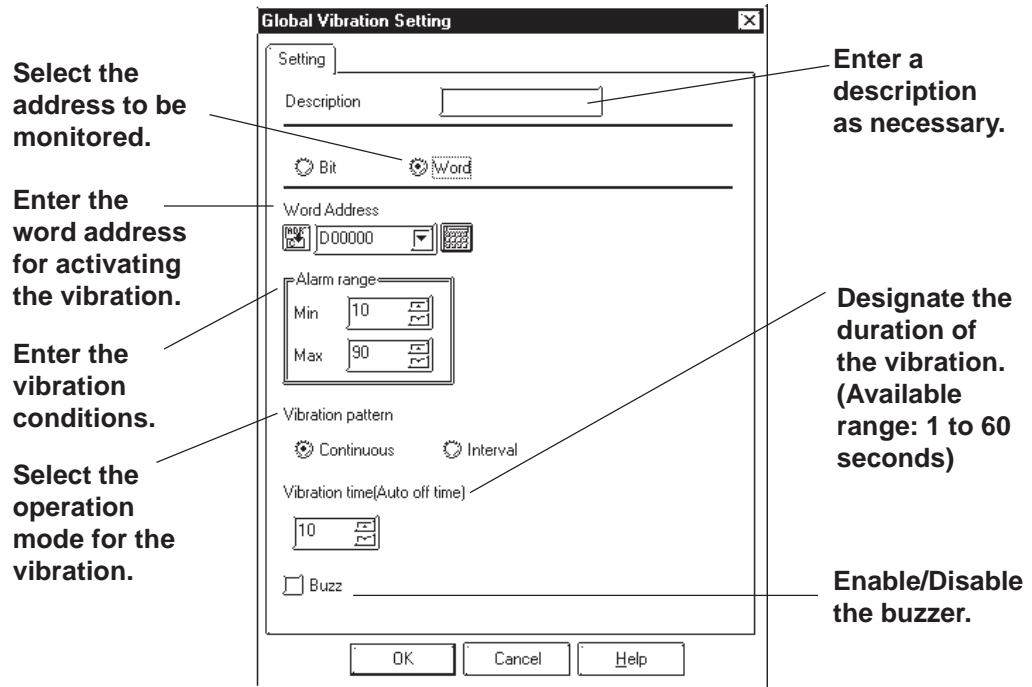

◆ **Mode**

Select either the Bit Address or Word Address for the device to be monitored.

◆ **Address**

Enter the Word Address used to trigger the Global Vibration here.

◆ **Alarm Range**

The vibration is triggered when the value of the word address being monitored exceeds the specified range. The Word Address is 16 bit, unsigned.

◆ **Vibration Pattern**

Select either Continuous or Interval mode for the vibration pattern.

· Continuous: The vibration continues for the period specified under the "Vibration Period" option without interruption.

· Interval: The vibration repeatedly activates for 0.5 seconds followed by a 0.5 second pause for the period specified in the "Vibration Time" option.

**Example:**  
Vibration time: 3 seconds

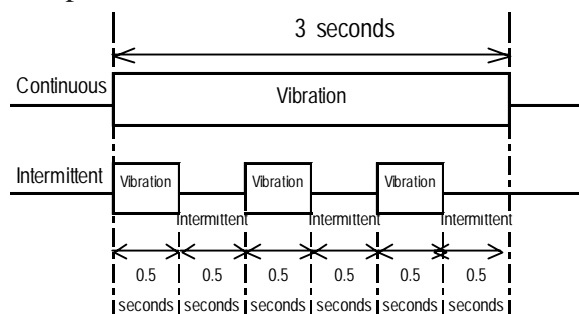



◆ **Vibration time (Auto OFF time)**

Specifies the duration of time after the vibration has been triggered.

The available range is from 1 to 60 seconds. The default setting is 10 seconds.

◆ **Buzzer**

When this option is enabled, the buzzer sounds according to the selected Vibration Pattern.

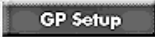
The buzzer will not sound if "Touch Buzzer Sound" is disabled in [System Setup] under the Project Manager's  window, even when the "Buzzer" function is enabled here.

■ **Vibration Modes**

Operation examples of vibration\*1 are shown below.

- 1) The vibration of the GP unit is triggered according to the settings when the specified Condition is satisfied\*2.

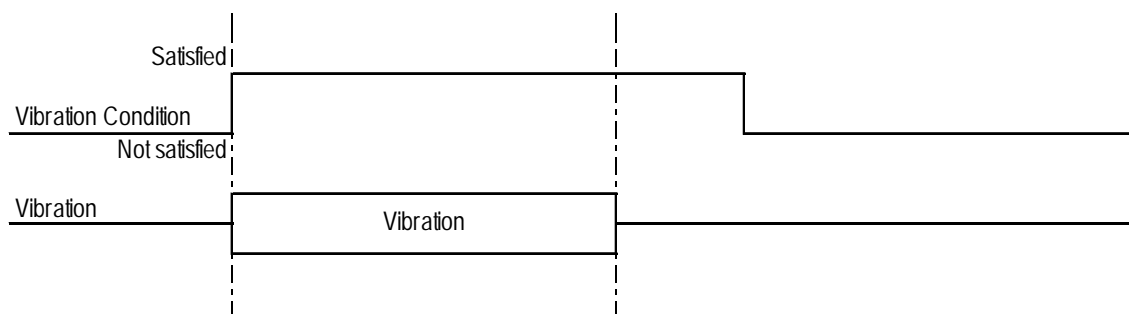

- 2) The vibration is not triggered a second time even if the Vibration Condition is satisfied again while the vibration is ON.

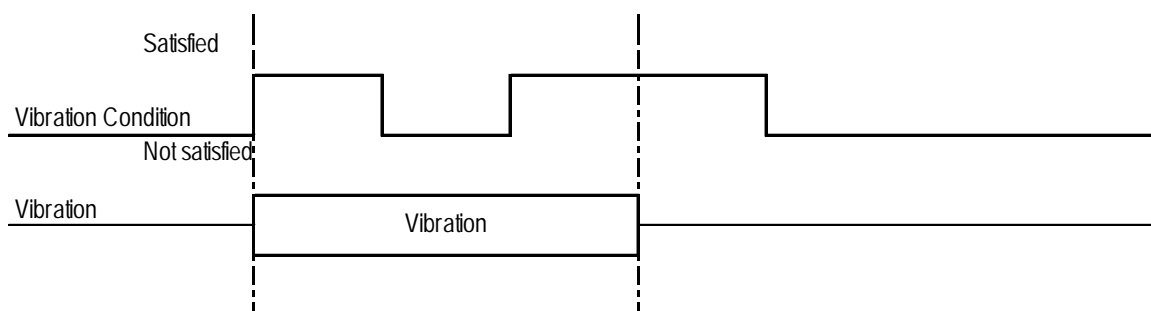

\*1: The vibration continues for the period specified in the "Vibration time" option in the [Global Vibration Settings] dialog box. The vibration is triggered when the Vibration Condition is satisfied regardless of the period required for the vibration to be completed, automatically stopping after the specified period has elapsed.

\*2: To trigger two consecutive vibration responses, hold the Trigger OFF time (the state in which the Vibration Condition is not satisfied) for the longer of the following two periods: the communication cycle time or the tag scan time.

3) The vibration in response to Vibration Condition (2) is triggered after the vibration in response to Vibration Condition (1) ends.

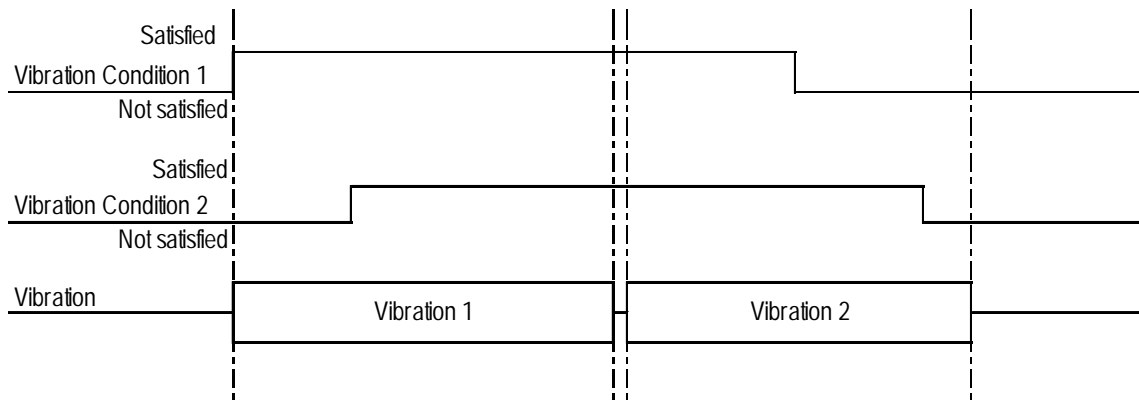

4) If Vibration Condition (2) is not satisfied, no vibration is triggered after the vibration in response to Vibration Condition (1) ends

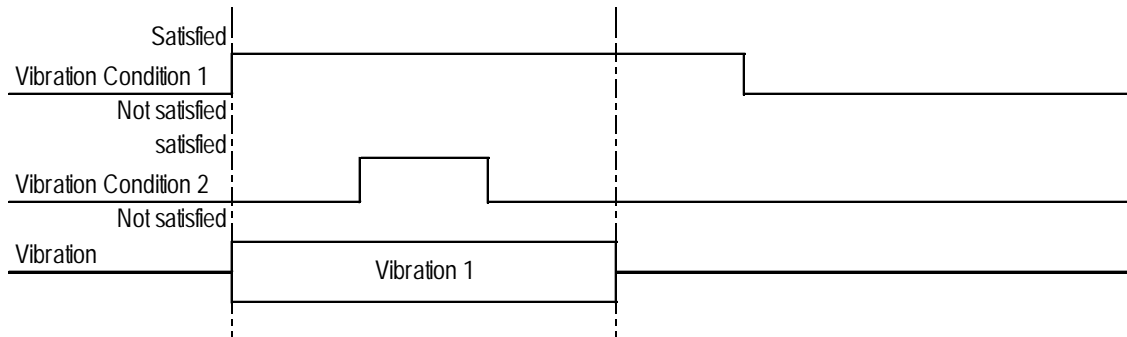



If two or more Vibration Conditions are satisfied at one time, vibrations are triggered in the sequence specified in the settings. However, note that the vibration may not be activated in the sequence specified with the GP-PRO/PB III, as activation depends on the timing of the communication readouts and internal monitoring.

### ■ Setting Up the Global Vibration Function

The Global Vibration Function setting procedure is described below.

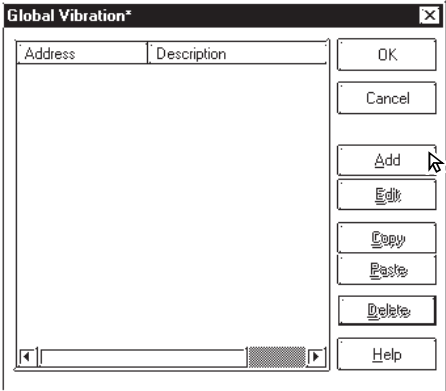
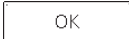
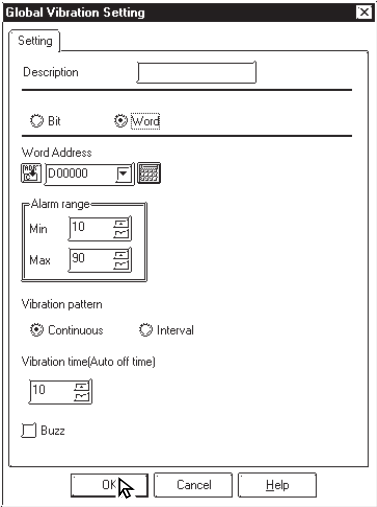
PROCEDURE	REMARKS
<p>(1) In the Screen Editor, select [Global Vibration] from the [Special] menu.</p> <p>(2) Click the  button, and set up the Global Vibration function.</p>  <p>(3) [Setting up the Global Vibration with a Bit Address] Enter the required options, and click .</p> 	

PROCEDURE	REMARKS
-----------	---------

**[Setting up the Global Vibration with a Word Address]**

Enter the required options, and click  .

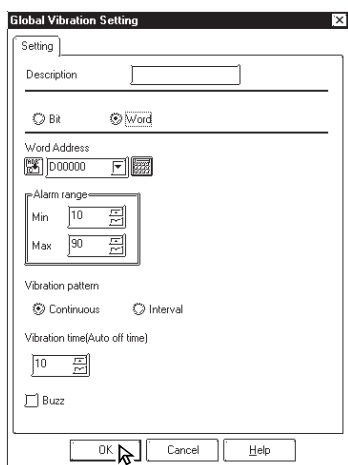

**(4) Review the details of the settings in the Global Vibration window, and click  to close the dialog box.**

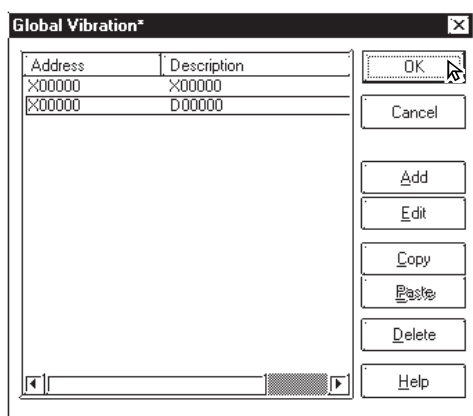

Clicking the  button displays the following dialog box.

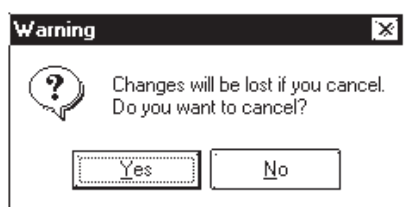

Click  to close the [Global Vibration] dialog box without saving the changes you have made.

Click  to return to the [Global Vibration] dialog box.

Click  to complete the setup operation.

Up to sixteen Global Vibratio settings can be set up within a single Project.

When two or more trigger conditions for the Global Vibration settings are satisfied at one time, vibrations are executed in the sequence registered in the Global Vibration settings. However, note that internal conditions may prevent the vibrations from being generated in the specified sequence.

## 2.12 Creating ST Series Screen

Be sure to read the following section prior to using your ST Series unit.

The following screens explain the ST400, ST401, ST402 and ST403 (hereafter called "ST") units.

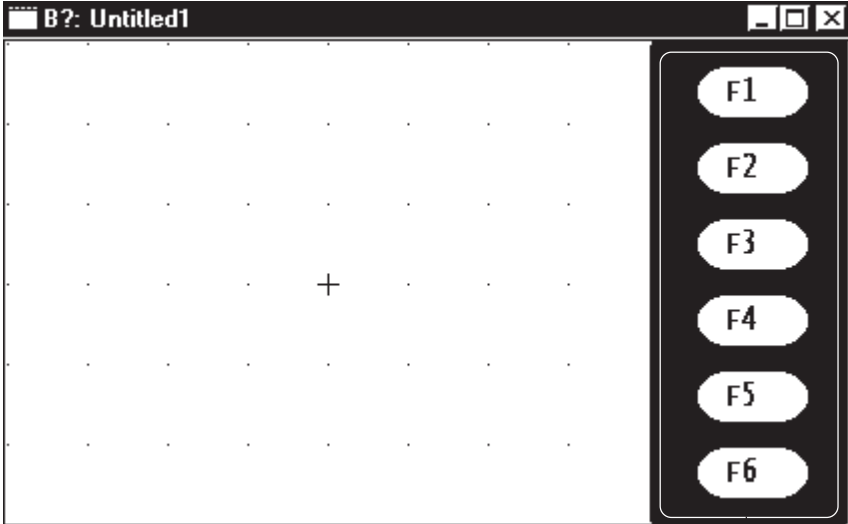

(ST Edit Screen)

Function Key Setting Area

### 2.12.1 Function Keys

The panel contains 6 function keys. Use these keys to perform touch input tag (T, t and k tag) settings.

There are two types of function key tag settings: local function key settings, and global function key settings. Local function keys operate only in the screen in which they have been set up. However, global function keys operate on all screens in which they have been set up.

No. of Tags that can be set using Function Keys

<b>Local (for a single screen)</b>	up to 384 (Total number of all tags on a single screen, however, does not include tags set on function keys.)
<b>Global (Single project)</b>	24 (Total number of T-tag, t-tag* <sup>1</sup> and k-tags.)

When performing local function key and global function key settings simultaneously, global function key tag settings will be performed first.

Tags set using function keys cannot be used to perform AUX output or reverse display.

#### ■ Function Key Settings

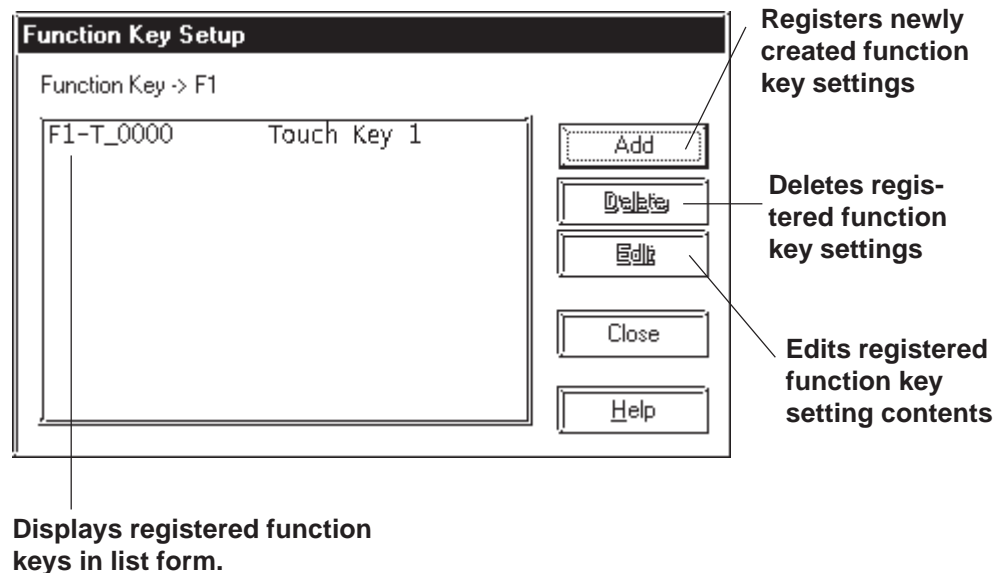

\*1 A single t-tag is counted as 2 regular tags.

■ **Setting up Local Function Keys**

The Local function key setting procedure is explained below.

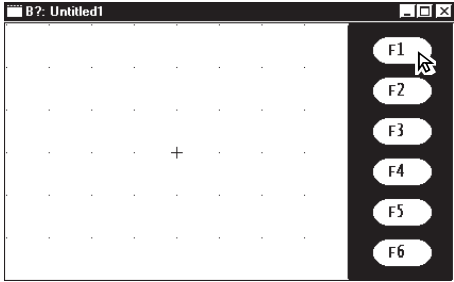
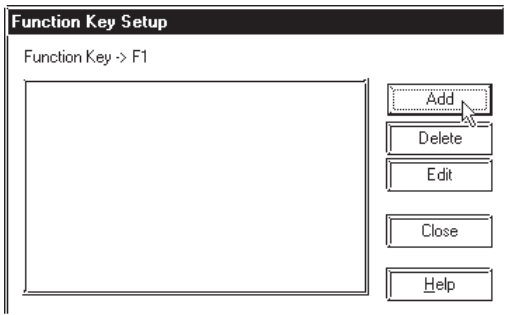
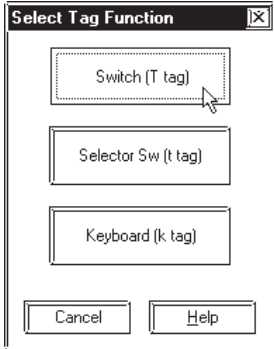
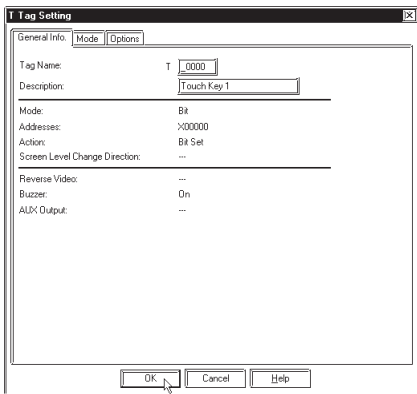
PROCEDURE	REMARKS
<p>(1) Double-click the function key you want to set up.</p> 	
<p>(2) Click <input type="button" value="Add"/>.</p> 	
<p>(3) Click the tag you want to set for the function key.</p> 	
<p>(4) After performing all item settings, click <input type="button" value="OK"/>.</p> 	

Multiple Tags can be assigned to a Single Function Key; however, there is a limit to the number that can be used.

For details regarding individual tag settings, **Reference** *Tag Reference Manual, Chapter 2, Active Image Functions*

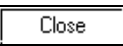
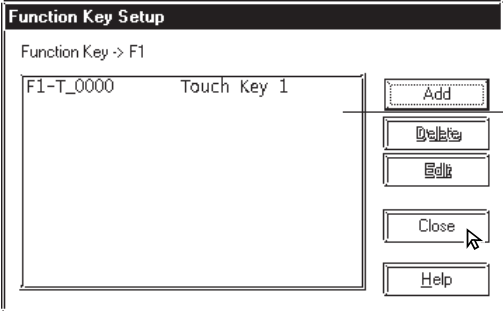
PROCEDURE	REMARKS
<p>(5) Click  to register your function key setting.</p>  <p>Displays the registered item</p>	<p>To continue setting up function keys, repeat from step 2.</p>

**■ Setting up the Global Function Key**

The Global function key setting procedure is explained below.

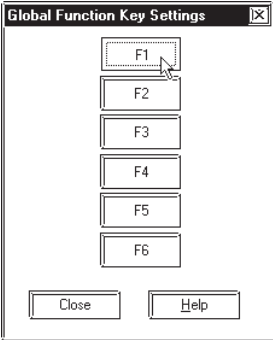
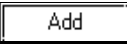
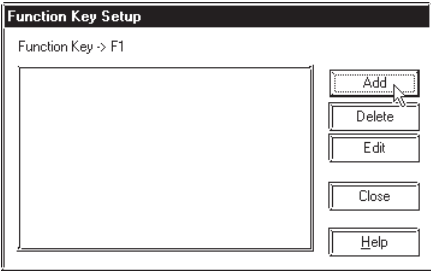
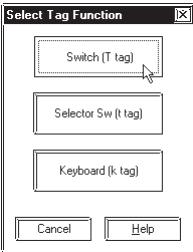
PROCEDURE	REMARKS
<p>(1) Select [Special (C)] menu's [Global Function Key (G)] feature.</p> <p>(2) Click the function key you want to set up.</p>  <p>(3) Click  .</p>  <p>(4) Click the tag you want to set for the function key.</p> 	<p>Before this selection, open any Base screen.</p> <p>k tag [Operation Mode] FEP settings cannot be used, due to ST hardware specifications</p>

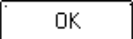
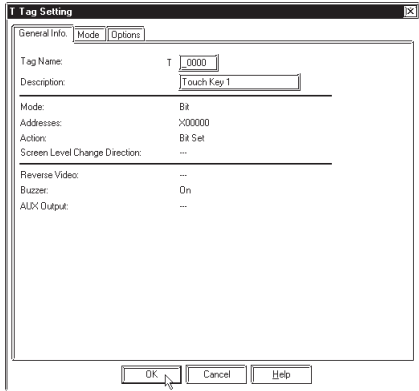
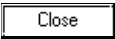
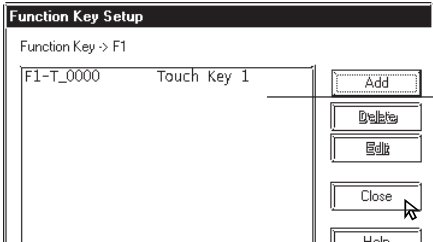

PROCEDURE	REMARKS
<p>(5) After performing all tag settings, click .</p>  <p>(6) Click  to register your function key setting.</p>  <p style="margin-left: 400px;">Displays the registered item</p>	<p>Even though multiple tags can be set up within a single function key, there is a limit to the maximum number of tags.</p> <p>For details regarding individual tag settings, <b>Reference</b> <i>Tag Reference Manual, Chapter 2, Active Image Functions.</i></p> <p>To continue setting up function keys, repeat from step 2.</p>

### ■ Function Key Usage Notes

- In addition to ST units, function keys can also be used on Handy-type GP units. For details regarding Handy-type GP unit function keys, **Reference** *2.11.1 Function Keys.*
- The ST is designed to provide 6 function keys. When changing the GP type unit selection to a Handy-type GP unit, function key positions may change due to the difference in number of function keys. However, this does not occur if the GP type in use before the change was GP-H70 or GP-2301H series.
- When using ST unit function keys, the following [k-tag] → [Mode] area features, even if set, will not operate.
  - <Cancel> for Logging Setting

**2.12.2 Backlight Color Change**

The backlight of the ST403 features two colors: amber and red. By switching the colors of the backlight, alarms and other information can be expressed without using the buzzer, sound outputs, or screen displays.

The backlight illuminates in amber during normal operation. The backlight illuminates in red only when the Change condition of the desired device is being satisfied.

The setting of the Backlight Color Change is common to all screens. Up to 16 Change conditions can be specified. The backlight illuminates in red when at least one of the 16 Change conditions is being satisfied.



- The Backlight Color Change feature is supported only by the ST403.
- The backlight illuminates in amber during a screen transfer operation.
- When the Change condition is satisfied while the GP is in the standby mode, the standby mode will be cancelled and the backlight will switch to red.  
While the backlight is illuminated in red, the GP will not enter the standby mode even with the execution of the following events.
- When the display is turned off by turning ON/OFF the screen display of the System Data Area
- When the specified standby duration has elapsed



The following provides an overview of the Backlight Color Change setting screen.

Displays the list of addresses to be monitored for registered Backlight Color Change settings along with the comments.

Used to add register settings for the Backlight Color Change.

Used to change the settings of the Backlight Color Change.

Used to copy the settings of the Backlight Color Change.

Used to paste the copied settings of the Backlight Color Change

Used to delete registered settings of the Backlight 2-color

■ **Setting Up the Backlight Color Change with the Bit Address**

The following provides an overview of the Backlight Color Change when the "Bit Address" is designated for the monitoring parameter.

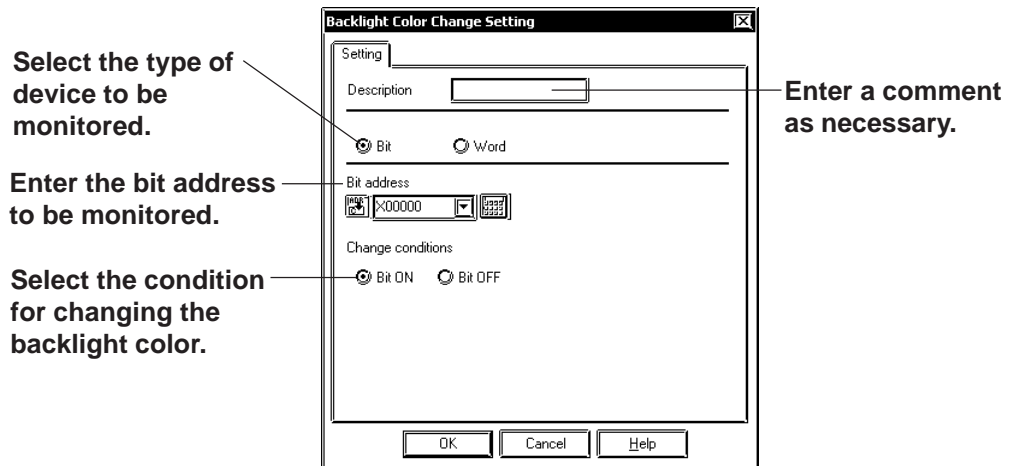

◆ **Mode**

Select either the Bit Address or Word Address for the device to be monitored.

◆ **Bit Address**

Enter the Bit Address to be monitored.

◆ **Change Conditions**

Specify the condition for changing the backlight color to red.

Condition for changing to red	Status of the Bit Address	Backlight Color
Bit ON	ON	Red
	OFF	Amber
Bit OFF	ON	Red
	OFF	Amber

## ■ Setting Up the Backlight Color Change with the Word Address

The following provides an overview of the Backlight Color Change when the "Word Address" is designated for the monitoring parameter.

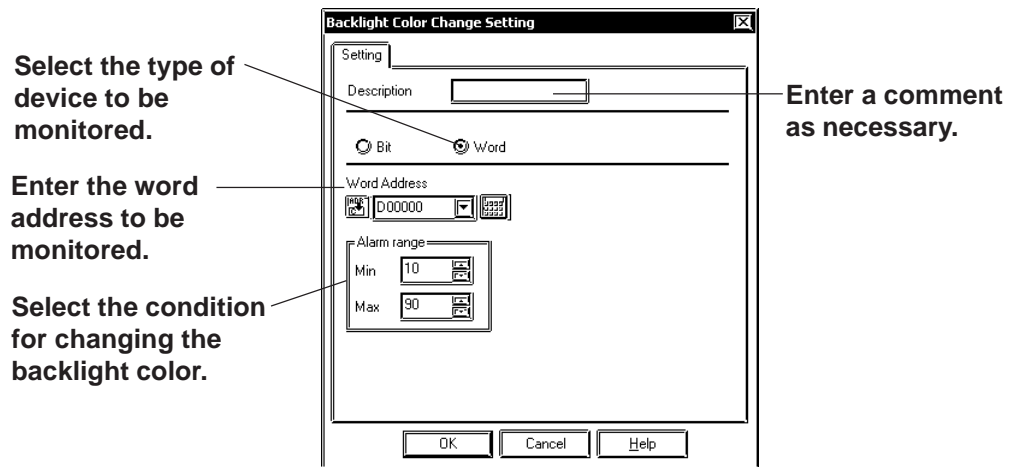

### ◆ Mode

Select either the Bit Address or Word Address for the device to be monitored.

### ◆ Word Address

Enter the Word Address to be monitored.

### ◆ Alarm Range

Specify the condition for switching the backlight color to red. When the word address that is being monitored exceeds the specified minimum or maximum value, the backlight color turns to red.

The format of the word address is unsigned 16 bits.

■ **Setting the Backlight Color Change**

The Backlight Color Change setting procedure is given below.

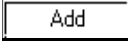
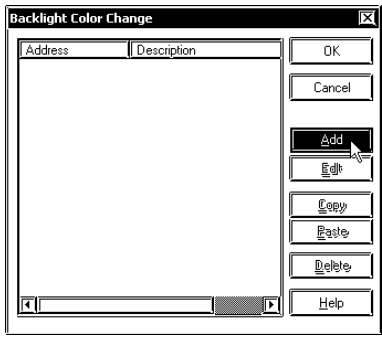
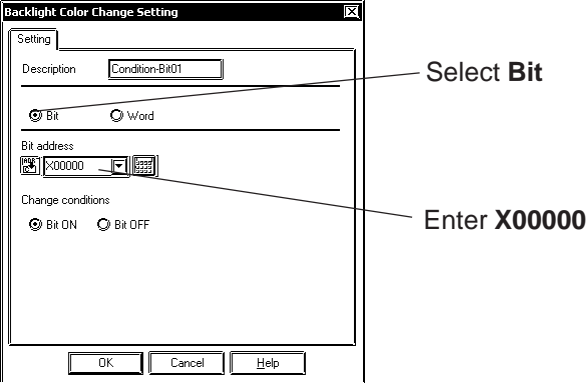
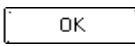
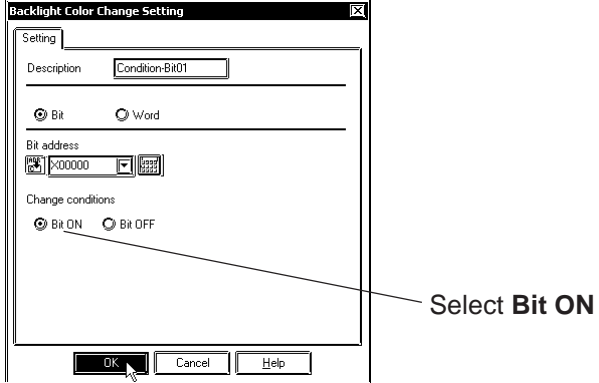
PROCEDURE	REMARKS
<p>(1) On the Screen Editor, select the [Function] menu-[Backlight Color Change] command.</p> <p>(2) Click on the  button and set up the Backlight Color Change settings.</p>  <p>&lt;When setting up the Backlight Color Change with the Bit address&gt;</p> <p>(3) Select "Bit" and then enter the bit address to be monitored.</p>  <p>(4) Select the condition for switching to red and click on the  button to confirm.</p> 	

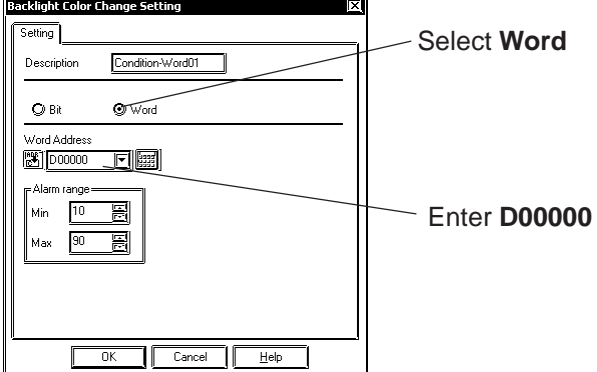
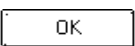
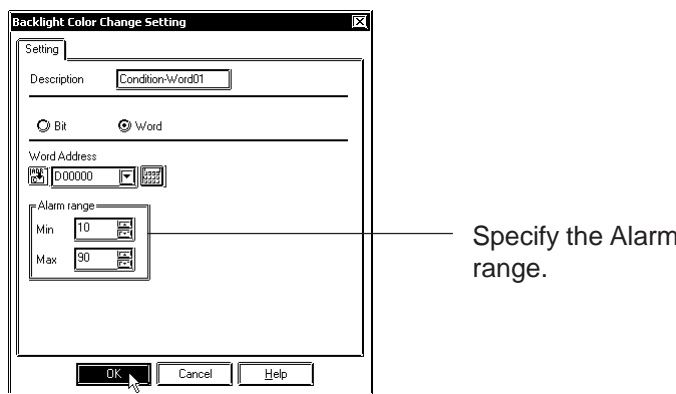
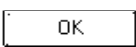
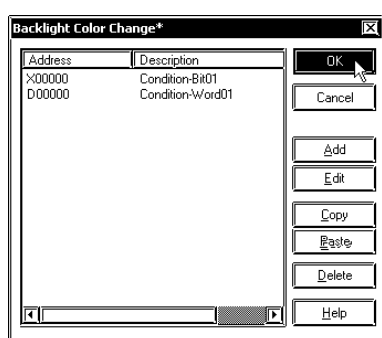
PROCEDURE	REMARKS
<p>&lt; When setting up the Backlight Color Change with the Word address &gt;                      (3) Select "Word" and then enter the word address to be monitored.</p> 	<p>When a comment is entered, it is displayed in the list on the [Backlight Color Change] dialog box.</p>
<p>(4) Specify the Alarm range and click on the  button to confirm.</p> 	
<p>(5) Review the settings on the Backlight Color Change dialog box and then click on the  button to close the dialog box.</p> 	<p>Up to 16 Backlight Color Change settings can be specified in one project.</p> <p>To set up another Backlight Color Change, do not exit the setting screen. Resume the operation from Step (2).</p> <p>When two or more Backlight Color Change settings are specified, the backlight color will switch to red if one of the conditions is satisfied.</p>

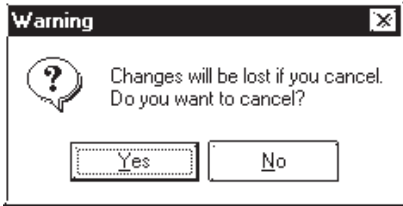
PROCEDURE	REMARKS
<p>Clicking the <input type="button" value="Cancel"/> button will display the following dialog box.</p>  <p>The image shows a Windows-style warning dialog box. The title bar reads 'Warning' with a close button (X) on the right. On the left is a question mark icon. The text inside says 'Changes will be lost if you cancel. Do you want to cancel?'. At the bottom are two buttons: 'Yes' and 'No'.</p> <p>Click the <input type="button" value="Yes"/> button to close the Backlight Color Change dialog box without saving the settings currently being edited.</p> <p>Click the <input type="button" value="No"/> button to return to the Backlight Change Color Change dialog box.</p> <p>Click <input type="button" value="OK"/> to exit.</p>	

### 2.12.3 Restrictions

Functions supported by the ST Series are basically the same as those supported by the GP-2301L Series of the GP2000 Series. In this manual, please read the word "GP" (GP2000 Series or GP-2301L for the functions with restrictions) as "ST". However, please note that an ST403 unit features an Ethernet interface.

However, ST units have certain restrictions owing to hardware specification differences with GP-2301L units. Be sure to understand this restriction information thoroughly before using your ST unit.



**Note:** · Functions not available with your ST unit are described in the [GENERAL GP RESTRICTIONS] section. Please be sure to read this section.

#### ■ Touch Panel

According to ST hardware specifications, the minimum size touch area is 40X40 (dots).

#### ◆ Direct Touch via Q Tag Alarm / File Item Display Device/ Logging Display Device

Due to the ST Series unit specifications, the ST unit's touch panel can not be operated when using the following functions.

- Q-tag alarm summary direct selection
- File item display's direct selection of filing data
- Logging display's direct edit of logging data

#### ◆ Pop-up Keypad

When editing the Keypad Input Display's Pop-up Keypad, the Pop-up Keypad library's 20-dot unit Keypad will not operate even when selected / set.



◆ **Grid/Snap**

If you choose an ST unit for your project's GP type (ST400/ST401/ST402/ST403), the grid's initial setting will be 40 x 40, not 20 x 20.

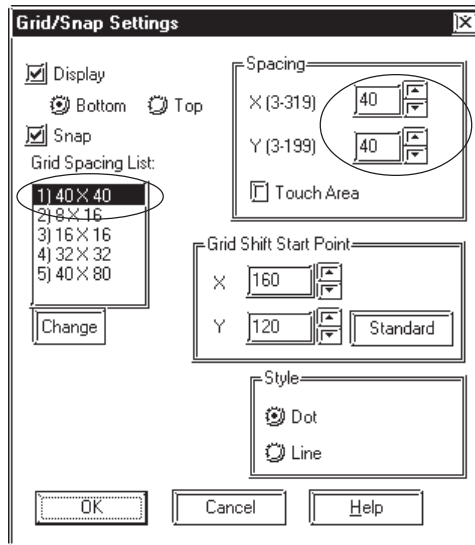

For information about use of the Grid/Snap features,

**Reference** 2.10.1 Grid/Snap

### ■ Extended Serial I/F

This feature's settings will vary depending on the type of ST Series unit you are using.

### ◆ Serial I/F Switchover

This feature's usage and communication restrictions will vary depending on the type of ST Series unit you are using. See the following table for details.

Series Name	Model Name	Standard Built-in I/F	Available Communication Method	
			Without I/F Switchover	With I/F Switchover
ST Series	ST400	Serial I/F (D-sub 9-pin)	Standard Protocol RS-422 (2-wire/4-wire)	Extended SIO Protocol RS-422 (2-wire/4-wire)
	ST401	Serial I/F (D-sub 9-pin)	Standard Protocol RS-232C	Extended SIO Protocol RS-232C
	ST402	Serial I/F (D-sub 9-pin)	Standard Protocol MPI	Extended SIO Protocol RS-422 (2-wire) <sup>*1</sup>
		Extended Serial I/F (D-sub, 9-pin)	Extended SIO Protocol RS-422 (2-wire/4-wire)	Standard Protocol RS-422 (2-wire/4-wire)
	ST403	Serial I/F (D-sub 9-pin)	Standard Protocol RS-422 (2-wire/4-wire) /RS-232C Switchable	Extended SIO Protocol RS-422 (2-wire/4-wire) /RS-232C Switchable
		Ethernet I/F	Standard Protocol Ethernet	Standard Protocol Ethernet

For details about the Serial I/F Switchover feature, **Reference** 4.2.8 *Changing Extend SIO Type*



· ST series unit OFFLINE screens cannot be used to set the Serial Interface Switch feature. This feature must be set via the editor software and the project data then transferred to the ST Series unit.

### ■ No Built-in CF Card Interface

The ST unit's design does not include a CF Card interface. As a result, CF Card-related features cannot be used.

### ■ Backup SRAM Capacity

The backup SRAM capacity of the ST unit is 96KB.

For detailed information, **Reference** *Tag Reference Manual 4.11 Backup SRAM Capacity*

### ■ Screen Capacity

The screen capacity of the ST unit is 640KB.

\*1 When switching the serial I/F with the ST402, use the extended SIO protocol with the 2-wire method of RS-422.

## 2.13 DXF Conversion

This feature allows you to convert DXF (Drawing Interchange File) file data into Base screen data, and to convert Base screen data into DXF file data. (A DXF file is an Auto Cad® drawing file)



**DXF filenames must be alphanumeric.**

**DXF can be used for the Release 12 program. If a newer version's data is used, that data will not be converted.**

**When each object's coordinates are converted, errors may occur, thereby slightly changing them.**

**Once a DXF file data is converted into Base screen data, even if the Base screen is again converted back into the original DXF file, or vice-versa, the resulting data may be unusable.**

**When converting data, be sure that the screen's width and height ratio will be the same for both the Base screen and the DXF file (Screen size settings: \$LIMMAX, \$LIMMIN). If this ratio is different, after data is converted, object locations or shapes will also be different from the original.**

### 2.13.1 Conversion from DXF File to Base Screen (DXF → PRW)

DXF file data is converted into Base screen data.

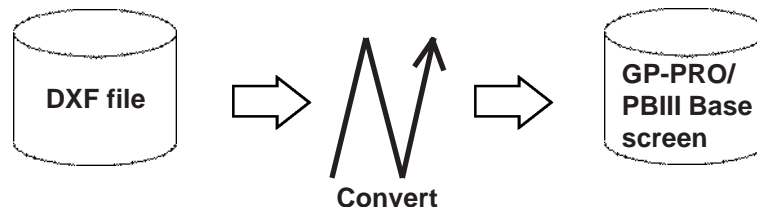

#### ■ Requirements and Restrictions when Converting Data (DXF → PRW)

- Grouped objects (Blocks) can be nested up to 10 layers (levels deep).
- The DXF file data format is ASCII. Both “CR LF” and “LF” can be used as line feed characters and will be converted correctly.
- During conversion, when the resulting output file's size reaches 16Kbytes, the conversion will quit, and subsequent data will not be converted.
- Three dimensional data cannot be converted.
- If the X,Y coordinate screen boundaries (\$LIMMIN, \$LIMMAX) are not set up correctly in the DXF file, after the data created in the DXF file is converted into Base screen data, it may go beyond the Base screen's display area.

- After DXF file data is converted into Base screen data, the DXF file name is used as the Base screen's description.
- When a layer's attribute has been turned OFF, that layer's data will not be converted, and only ON layer data will be converted into Base screen data.
- Fill and Oval/Arc data cannot be converted.

### ■ Option (DXF → PRW)

Here, select and enter the color and size used when converting data. According to the specified DXF and Base screen size, data will be relatively magnified or minimized when converted.

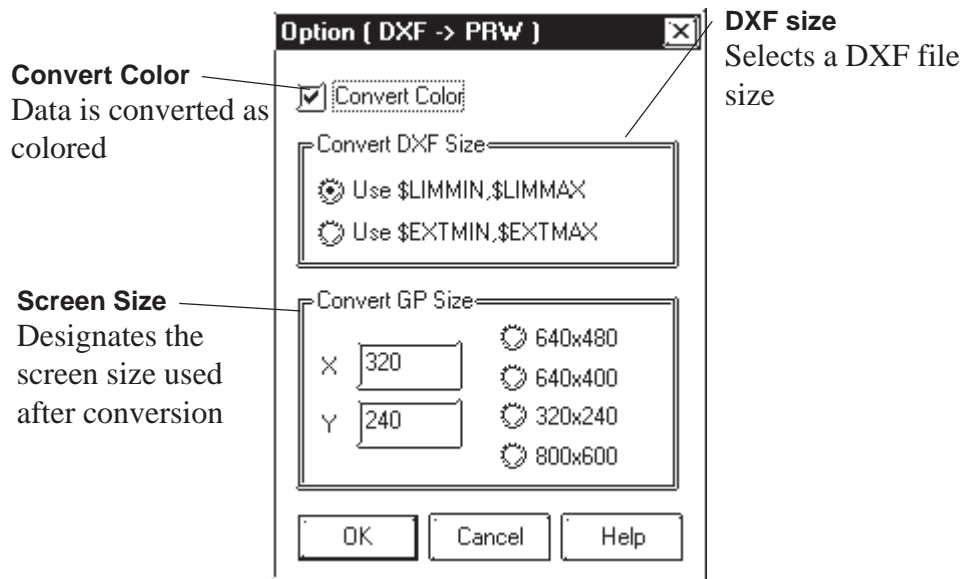

#### ◆ Convert Color

When this box is checked, DXF file data is converted as colored. When this box is not checked, DXF file data is converted as monochrome.

#### ▼ Reference 2.13.1 ■ Color Conversion (DXF → PRW)

#### ◆ Convert DXF Size

The DXF file data conversion range is selected.

When "Use \$LIMMIN, \$LIMMAX" is selected, data in the DXF file's maximum screen area (X,Y coordinate screen boundaries) will be converted. When "Use \$EXTMIN, \$EXTMAX" is selected, only data in the DXF file's object area will be converted.

#### ◆ Convert GP Size

The Project File screen size (GP screen size) used after conversion is specified.

### ■ Color Conversion (DXF → PRW)

When the [Option] dialog box's [Convert Color Data] check box is checked, the DXF file's color data will be converted as follows:

DXF File Color No.	Base Screen
1 (red), 1X (red-based)	Red
2 (yellow), 5X (yellow-based)	Yellow
3 (green), 9X (green-based)	Green
4 (light blue), 13X (light blue-based)	Light blue
5 (blue), 17X (blue-based)	Blue
6 (purple), 21X (purple-based)	Purple
7 (white)	White
Other colors	White

The background color will be converted into Black.

### ■ Line Type Conversion (DXF → PRW)

Each DXF file's line type will be converted as follows:

DXF File	Base Screen
CONTINUOUS	——— Solid line
DASHED	- - - - Broken line
HIDDEN	- - - - Broken line
CENTER	- · - A dot-dash-line
PHANTOM	- · · - Two dot-dash-line
Other	——— Solid line

The user defined line types will be converted into solid lines.

### ■ Object Conversion (DXF → PRW)

The DXF file's objects will be converted as follows.

Colors and line types will be converted as shown above. Tiling patterns will be converted into solid Fill.

DXF File	Base Screen
LINE	Straight line
POINT (dot)	Straight line (The start and end are the same point)
CIRCLE	Regular circle
ARC	Arc
TRACE (thick line)	Filled polygon
SOLID (filled object)	Filled polygon
TEXT (characters and signs)	Text
DIMENSION (dimension indicator)	Straight line
INSERT (inserting object)	Conversion breaks down complex objects into component parts (objects)
ATTRIB (attribute)	Conversion breaks down complex objects into component parts (objects)
POLYLINE (polyline/donut-shaped/oval/polygon/rectangle)	Continuous straight line
VERTEX	Vertex coordinates of a continuous straight line

Objects other than the above will not be converted.

Each object's elements, other than colors and line types, will be converted as follows:

◆ **POINT (dot)**

- A dot's pattern will be converted into "0" (point), and its display size will be converted into "0,0".
- A dot will be converted to a straight line, with the start and end coordinates at the same point.

◆ **TEXT (characters and signs)**

- A rotation angle will be converted into an angle closer to 90°, 180°, 270°, or 360°. (in 90° units)
- The character size will be converted into a size closer to either 1, 2, 4, or 8 x magnification.
- Special characters that will be converted are %%d (°), %%c (φ), and %%p (±).
- When text contains more than 100 characters, it will be divided every 100 characters into records of data and then converted.
- When more than 100 character text is divided into records of data, groups of overflowing characters after the first 100 characters will be dislocated toward the right bottom for a few dots.
- Tilting angles, character fonts, and character spacing will not be converted.
- Text will be converted based on the ASCII code; therefore, the character style (Standard, Bigfont, etc.) or font file settings will be ignored.
- When text with half-sized and full-sized characters mixed in vertical lines is converted, the half-sized characters will be centered.

◆ **DIMENSION (Dimension Indicator)**

- During conversion, the breaking down of a grouped object (Block) is performed by referring to the Block's sections, which indicate the Block's component parts (objects). However, dots will not be converted.

◆ **INSERT (Inserting Object)**

- A grouped object defined in the Block section will be broken down into each drawing object and converted.
- Up to 10 layers of nested data will be converted. However, since all the data will be converted into a single layer on a single screen, the objects over the limit (file capacity) will not be converted.
- Although the rotating angles, and the number of lines and columns can be converted (lines and columns of the objects over the limit will not be converted), their ratio (scaling) will not be converted.
- The grouped object created in Layer "0" will be converted based on the inserted layer's colors and line types, however, a grouped object created in an other layer level will not be converted based on the inserted layer's colors and line types. In this case, if BYBLOCK is specified to the grouped object, the inserted layer's colors and line types will be used.
- Simulated object sectioning (hatching) data cannot be converted, since, when the Block section's hatching data pattern is converted into each drawing object, that data size can exceed the GP file capacity.
- If another file's grouped object has been inserted or another file is referred, that grouped object will not be converted.

◆ **ATTRIB (attribute)**

ATTRIB (attribute) data is part of INSERT data.

- Attribute data will be converted in the same manner as TEXT conversion.



◆ **POLYLINE (polyline/donut-shaped/oval/polygon/rectangle)**

- POLYLINE data will be converted connecting the following VERTEX's coordinates with a continuous straight line. Only data whose polyline flag is either "0 (default)", "1 (closed polyline)", "2 (adding the fit curve vertex)", or "4 (adding the spline curve vertex)" will be converted.
- When the number of vertices exceeds 100, data will be divided every 100 vertices and converted.
- When the converted data's coordinates are repeated at the same point, the following coordinates will be omitted.
- When a polyline has curved sections, they will not be converted. Therefore, donut-shaped lines and curved polylines will be converted into continuous straight lines, connecting each coordinate point.

◆ **VERTEX**

- Top coordinates of a polyline.
- A polyline's width will not be converted.

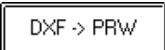
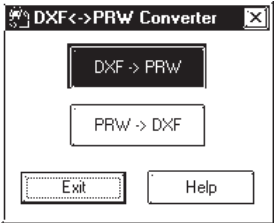
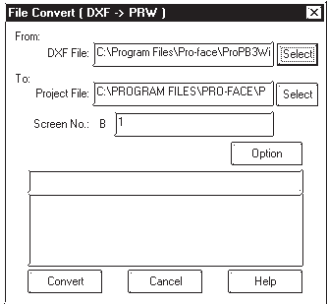
■ **Converting DXF File Data to Base Screen Data**

PROCEDURE	REMARKS
<p>(1) Select the pull down menu [Utility]'s [Convert DXF ] command.</p> <p>(2) Click on the  button.</p>  <p>(3) Designate the source (DXF file) and the destination (Project File), and enter the Base screen number.</p> 	<p>To designate a folder, click on the  button.</p>

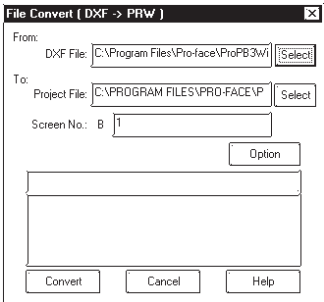
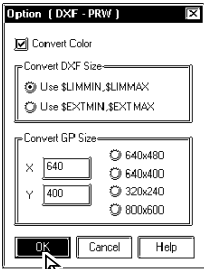
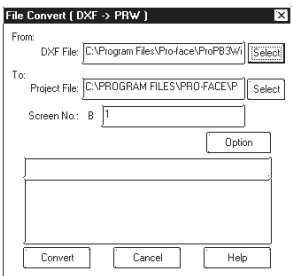
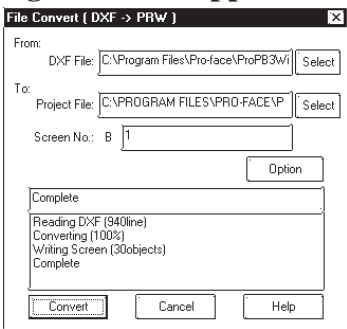
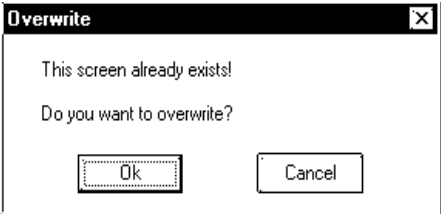
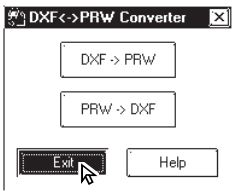
PROCEDURE	REMARKS
<p>(4) Click on the <b>Option</b> button and enter the conversion conditions.</p> 	
<p>(5) After all the attributes have been entered, click on the <b>OK</b> button to registered the entered data.</p> 	<p><b>Reference</b> 2.13.1 ■ Option (DXF → PRW)</p>
<p>(6) Click on the <b>Convert</b> button to start conversion.</p> 	<p>If the designated screen number already exists, a prompt will appear, asking whether the new number should overwrite the old number. When the <b>OK</b> button is clicked on, the new number will overwrite the old one, and when the <b>Cancel</b> button is clicked on, the new number will not overwrite the old one.</p>
<p>(7) After the conversion is completed, click on the <b>Cancel</b> button. The [DXF&lt;-&gt;PRW Converter] dialog box will reappear.</p> 	
<p>(8) Click on the <b>Exit</b> button to quit.</p> 	<p>To convert another DXF file, DO NOT cancel here; rather, start from step (3) again.</p>



**2.13 .2 Conversion from Base Screen to DXF File (PRW → DXF)**

Base screen data is converted into DXF file (Drawing Interchange File) data.

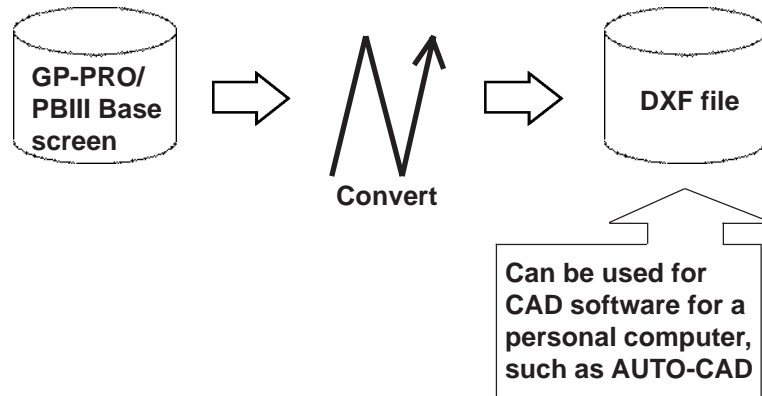

### ■ Requirements and Restrictions when Converting Data (PRW → DXF)

- Only Base screens can be converted.
- Image screens called up on the Base screen will not be converted.
- Tag data will not be converted, so for example, M-tag's Marks will not be displayed after conversion.
- When text is converted, the character size and position may differ from the original due to font type difference and errors created during conversion.
- Since Load Mark will be converted into a simple straight line (i.e. no width), if it has been magnified, it will be displayed differently from the original after it is converted.



***If you try to convert a filled polygon that has four peaks, one of which introverts, into a DXF file, this polygon will not be converted properly.***

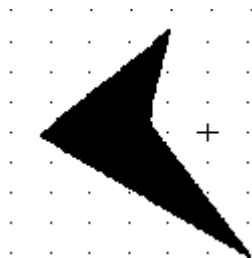

■ Option (PRW → DXF)

Here, select and enter color and size data used when performing data conversion.

**Screen Size**

Designates the GP screen size after conversion

**DXF size**

Designates the DXF screen size when Base screen data is converted into DXF file data

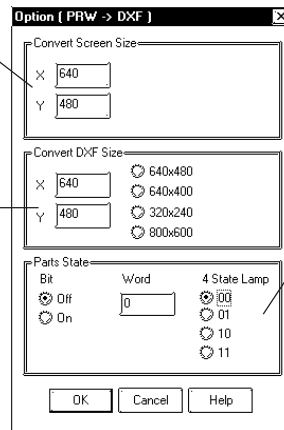

**Parts State**

Selects and enters the Part State when converted

◆ Convert Screen Size

The screen size of a GP unit specified in the Project File.

◆ Convert DXF Size

The DXF file size used after data is converted using data conversion is selected. The default values are the same as the Screen Size values mentioned above.

◆ Parts State

**Bit .....** When Part display states (ON/OFF) are specified, that Part will be converted for each display state.

**Word ..** Picture Display and Message Display will be converted with the display state specified here.

■ Color Conversion (PRW → DXF)

Base screen's drawing data colors will be converted as follows:

Base Screen	DXF File Color No.
Black	250 (gray)
Blue	5 (blue)
Green	3 (green)
Light blue	4 (light blue)
Red	1 (red)
Purple	6 (purple)
Yellow	2 (yellow)
White	7 (white)











The blink settings will not be converted.

With a 64 color GP unit, colors on the color palette will be converted as follows:

Black	Blue	Black	Black	Blue	Blue	Green	Green
Light blue	Light blue	Green	Light blue	Black	Black	Blue	Blue
Black	Black	Blue	Blue	Green	Green	Light blue	Light blue
Green	Green	Light blue	Light blue	Red	Red	Purple	Purple
Red	Red	Purple	Purple	Yellow	Yellow	White	White
Yellow	Yellow	White	White	Red	Purple	Red	Red
Purple	Purple	Yellow	Yellow	White	White	Yellow	White

### ■ Line Type Conversion (PRW → DXF)

Base screen's line types will be converted as follows:

Base Screen	DXF File
 1-dot solid line	CONTINUOUS
 1-dot broken line	DASHED
 1-dot one-dot-dash line	CENTER
 1-dot two-dot-dash line	PHANTOM
 2-dot solid line	CONTINUOUS
 2-dot broken line	DASHED
 2-dot one-dot-dash line	CENTER
 2-dot two-dot-dash line	PHANTOM
 3-dot solid line	CONTINUOUS
 5-dot solid line	CONTINUOUS

The line thickness will be converted in the same thickness for all the lines, regardless of the line types.

### ■ Object Conversion (PRW → DXF)

Base screen's drawing data will be converted as follows.

Colors and line types will be converted as shown in the previous page's table. The background colors will not be converted. Tiling patterns will be converted into solid Fill.

Base Screen	DXF File
Straight line/Continuous straight line	LINE/POLYLINE
Square/Filled Square	POLYLINE/SOLID
Regular Circle/Filled Regular Circle	CIRCLE/CIRCLE + SOLID
Oval/Filled Oval	POLYLINE/POLYLINE + SOLID
Arc/Pie	ARC/ARC + POLYLINE
Division	Collection of lines
Filled Polygon	SOLID or POLYLINE
Load Screen	Broken down into each Part object and converted
Text	TEXT
Load Mark	POLYLINE
Part	Broken down into each part and converted

Data other than the above will not be converted.

#### ◆ Straight line/Continuous straight line

- When the number of coordinates is "2", a straight line or continuous straight line will be converted into LINE. If this number is other than 2, it will be converted into POLYLINE.
- When a line has an arrow at one end, a solid filled triangle will be drawn at the end coordinates, and when a line has arrows at both ends, solid filled triangles will be drawn at both ends.

#### ◆ Square/Filled Square

- Any line will be converted into POLYLINE.
- Any Fill will be converted into SOLID.

**◆ Regular Circle/Filled Regular Circle**

- Filled regular circle's border will be converted into CIRCLE and its filling will be converted into SOLID.

**◆ Oval/Filled Oval**

- Any lines will be converted into POLYLINE.
- Filled oval's border will be converted into CIRCLE and its filling will be converted into SOLID.

**◆ Arc/Pie**

- Pie's straight line section will be converted into POLYLINE.

**◆ Divisions**

- When the divisions are marked on a straight axis, their coordinates will be calculated based on their start and end coordinates, direction, and the number of divisions, and will be converted into LINE.
- When the divisions are marked on an arc axis, their coordinates will be calculated based on their start and end angles, external circle's radius, internal circle's radius, number of divisions, and will be converted into LINE.

**◆ Filled Polygon**

- Fill will be converted into SOLID. However, if the number of vertices is more than 5, Fill will not be converted and only its trace will be converted into POLYLINE (CONTINUOUS).

**◆ Load Screen**

- The screen will be retrieved from its attributes, and screen number and if it exists, and each drawing data will be converted.
- The called up screen's data will be converted in the same layer as other drawing data.
- Only Base, Keypad, and Trend Graph screens will be converted.

**◆ TEXT**

- Characters written horizontally will be converted into BIGFONT. Those written vertically will be converted into TATEGAKI (vertical type of BIGFONT).
- 1/4-sized characters will be all converted into half-sized characters.
- Half-sized (1/4-sized) characters written horizontally will be converted with a relative scale of 1/2 in the X direction, and other size characters will be converted with a relative scale of 1.
- Both half and full-sized characters written vertically will be converted with a scale of 1 for their height and width. Therefore, the half-sized characters will become the same size as the full-sized characters.
- Character types of "Bold" and "Raised" will not be converted.
- Due to font difference and other elements, text will be different from the Base screen, after conversion.

**◆ Load Mark**



- The Mark screen will be retrieved from the screen number, if that screen exists, the dot pattern will be converted into POLYLINE (CONTINUOUS).

**◆ Part**

- Each Part's data will be converted into drawing data.

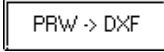
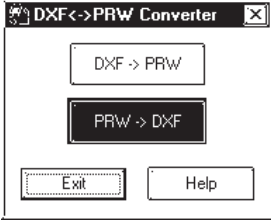
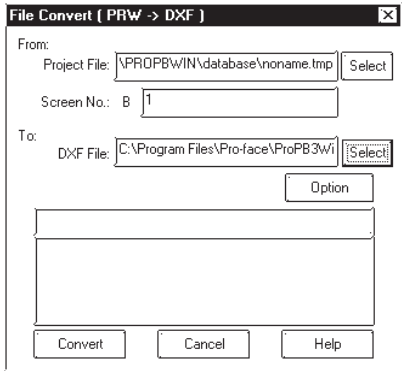
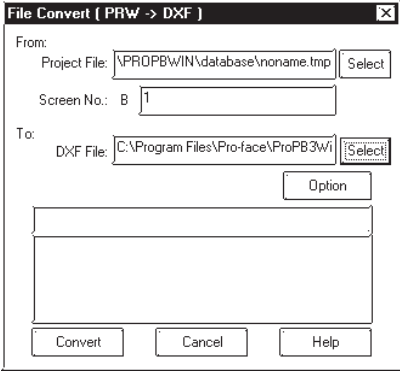
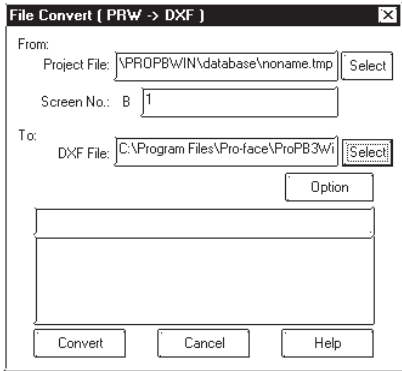
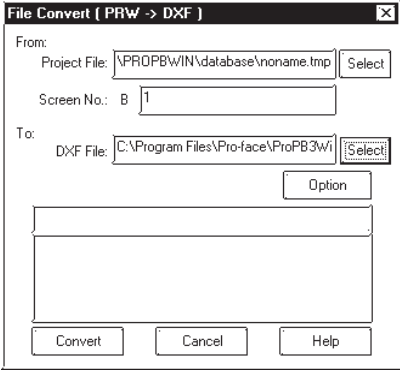
■ Converting Base Screen Data to DXF File Data

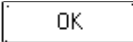
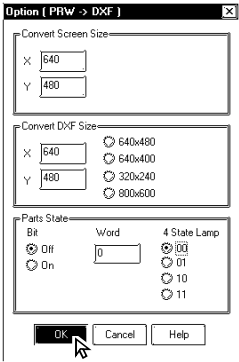
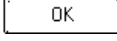
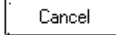
PROCEDURE	REMARKS
<p>(1) Select the pull down menu [Utility]'s [DXF Conversion] command.</p> <p>(2) Click on the  button.</p>  <p>(3) Designate the source (Project File) and Base screen number and designate the destination (DXF file).</p>  <p>(4) Click on the  button and enter the conversion conditions.</p> 	<p>To designate a folder, click on the  button.</p>

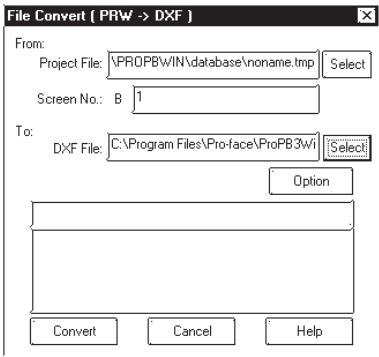
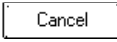
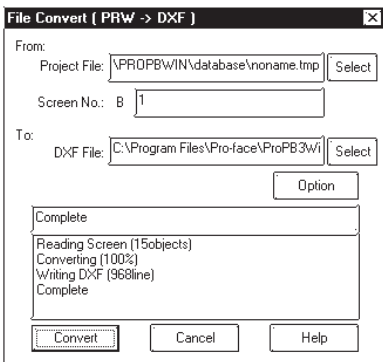
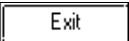
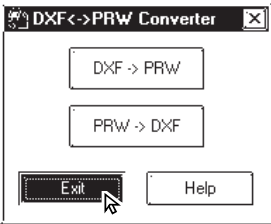
PROCEDURE	REMARKS
<p>(5) After all the attributes have been entered, click on the  button to registered the entered data.</p> 	<p><b>Reference</b> 2.13.2 ■ Option (PRW → DXF)</p> <p>If the designated DXF file name already exists, a prompt will appear, asking whether the new name should overwrite the old name. When the  button is clicked on, the new name will overwrite the old one, and when the  button is clicked on, the new name will not overwrite the old one.</p> <p>To convert another Base screen, DO NOT stop here; rather, start again from step (3).</p>
<p>(6) Click on the  button to start conversion.</p> 	
<p>(7) After the conversion is completed, click on the  button. The File Convert (GP → DXF) dialog box will reappear.</p> 	
<p>(8) Click on the  button to quit.</p> 	

**G**P-PRO/PB III for Windows provides various screens for specific purposes (for example: for creating marks and messages), in addition to the Base screens which are the fundamental screen used for all drawing modes. Other screens can then be loaded onto Base screens as libraries. Also, you can load them directly onto the GP series panel using specified tags.

This chapter describes the procedure for creating these screens and their applications.

- 3.1 ..... **Creating a Mark: the Mark Screen**
- 3.2 ... **Creating a Trend Graph: the Trend Graph Screen**
- 3.3 ..... **Creating a Keypad: the Keypad Screen**
- 3.4 ..... **Text Input: the Text Screen**
- 3.5 ..... **Creating an Image: the Image Screen**
- 3.6 ..... **Video Data Display (V Screen)**
- 3.7 ..... **Window Display: Window (U) Screen  
and Base (B) Screen**

# 3.1 Creating a Mark: the Mark Screen

Create a mark (dot pattern) on a “Mark” screen. Using the [Draw] menu - [Load Mark] command, you can load the created mark onto a Base screen, “Tend Graph” screen or “Keyboard” screen. Also, you can animate the created Mark screen by specifying the M-tag.

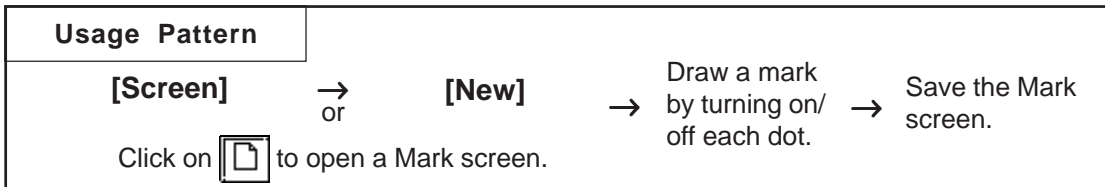



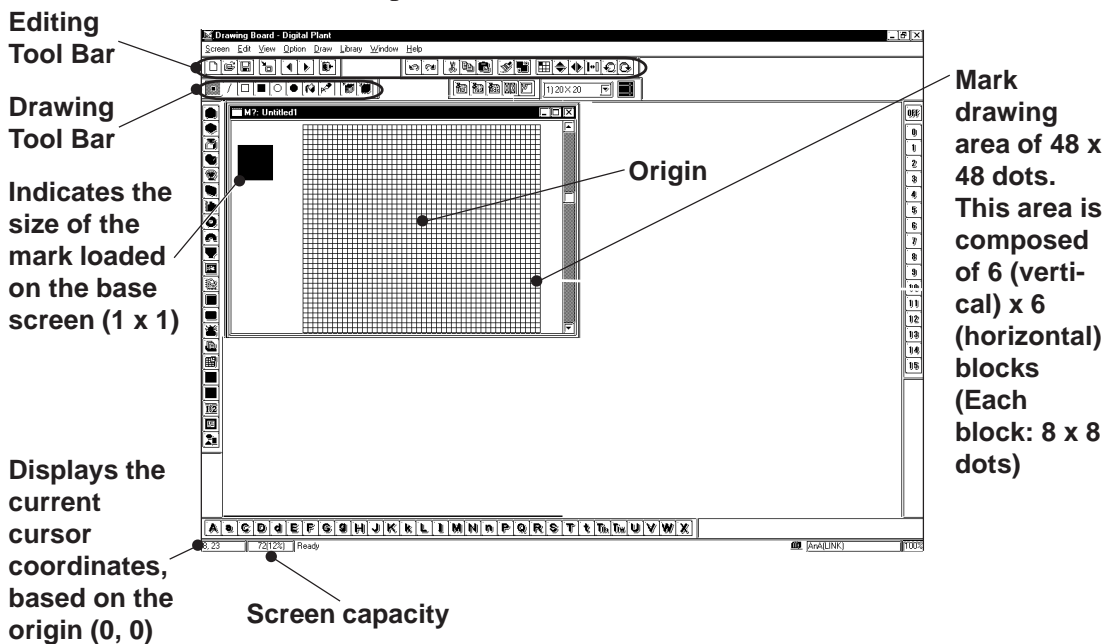



General description of the Mark screen:







## ■ Drawing Tools

The Drawing Tool Bar icons and their corresponding drawing objects are as follows:













Icon	Drawing Tool	Description
	Dot	Specify the ON/OFF status of each dot by clicking on each dot or dragging the mouse within a specified area.
	Line	Specify the start and end points of a line and draw a line by clicking on desired points.
	Square (Rectangle)	Draw a square or rectangle by clicking and dragging to the desired size on a diagonal axis.
	Filled square (Filled rectangle)	
	Circle/Oval	Draw a circle or oval by clicking and dragging to the desired size on a diagonal axis.
	Filled circle (Filled oval)	



Icon	Drawing Tool	Description
	<b>Fill</b>	Fill in an area with a desired color by clicking in the area (enclosed within lines and shapes).
	<b>Text</b>	Enter the text to be displayed in the mark drawing area.
	<b>Call Up Mark Library</b>	Select a Mark from the Mark Library
	<b>Register Mark Library</b>	Register a created Mark as a Mark Library.

### ■ Editing Tools

The Editing Tool Bar icons and their corresponding functions are as follows:

Icon	Editing Tool	Description
	<b>Cut</b>	Used to delete an entire Mark screen and store it in the clipboard*1. Using the [Paste] command, you can then paste the Mark screen onto another screen.
	<b>Copy</b>	Used to copy the data of the selected Mark screen in the clipboard.
	<b>Paste</b>	Used to paste the data temporarily stored in the clipboard onto a desired place.
	<b>Duplicate</b>	Used to duplicate a Mark screen's specified area.
	<b>Delete</b>	Used to delete a mark.
	<b>Undo</b>	Used to cancel the command executed immediately before, and return to the previous condition. (Undo)
	<b>Redo</b>	Used to redo the command canceled with the [Undo] command. (Redo)
	<b>Mirror X</b>	Used to move the dot pattern symmetrically relative to the vertical axis. The symmetry axis is the vertical line that divides the screen into two equal sections.
	<b>Mirror Y</b>	Used to move the dot pattern symmetrically relative to the horizontal axis. The symmetry axis is the horizontal line that divides the screen into two equal sections.
	<b>Turn counterclockwise</b>	Used to turn the mark counterclockwise by 90°.
	<b>Turn clockwise</b>	Used to turn the mark clockwise 90°.
	<b>Reverse</b>	Used to reverse the white/black area of a mark.
	<b>Transparent/Background color</b>	If no dots are turned ON in a block (8 x 8 dots), this block becomes transparent.

\*1 When the [Copy] or [Cut] command is used, the copied or cut data is temporarily stored in the clipboard.

When you use the [Paste] command, the data stored in the clipboard are pasted to the selected position.

### ■ Mark Drawing Area Structure

The mark drawing area has the following structure. When you edit a mark, you can use this for your reference.

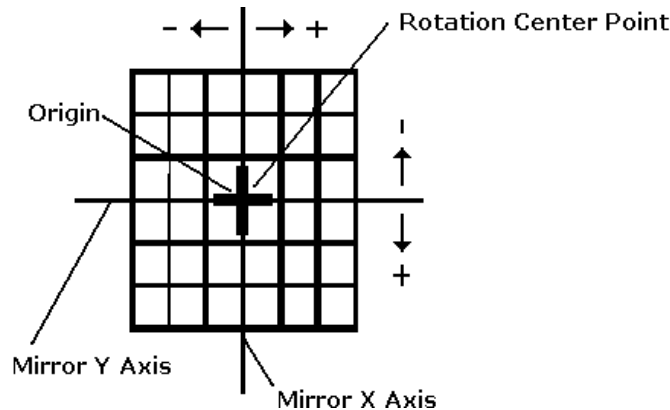

#### 3.1.1 Drawing a Mark

When drawing a mark you can use GP-PRO/PBIII for Windows' standard drawing functions. Here, the procedures for using each function are described.

#### ■ Drawing with Dots

You can draw a mark by turning ON/OFF each dot. When you click the left mouse button in the mark drawing area, each dot turns ON (white). When you click the right mouse button in the mark drawing area, each dot turns OFF (black).

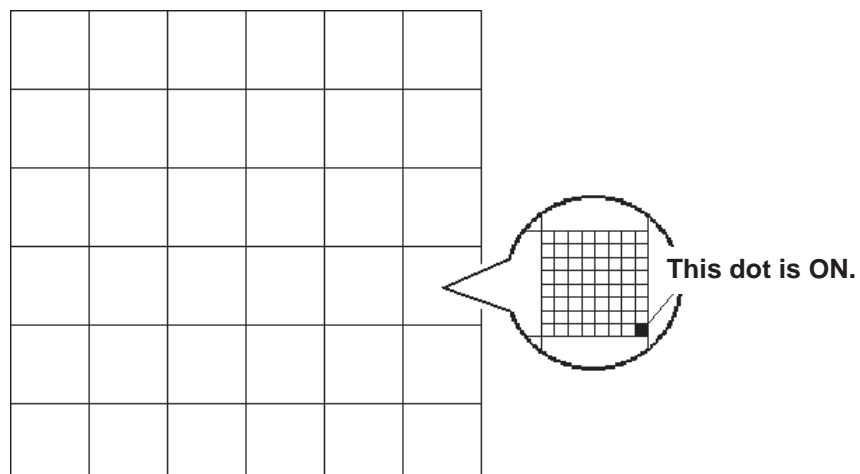

A mark is created with dots, and displayed in a block (8 x 8 dots). If at least one dot is turned ON in a block, the whole block is displayed when the Mark screen is loaded onto a Base screen. In this status, the ON dots are displayed in the current display color (Fg), and the OFF dots are displayed in the background color (Bg).



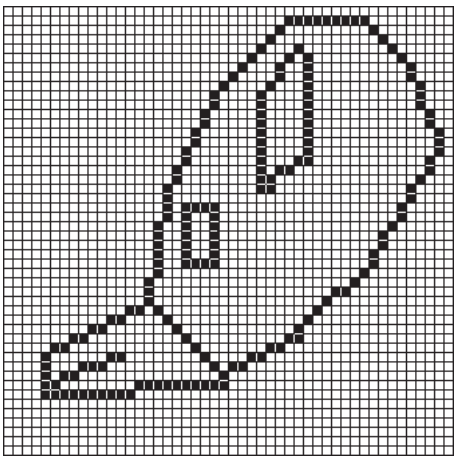

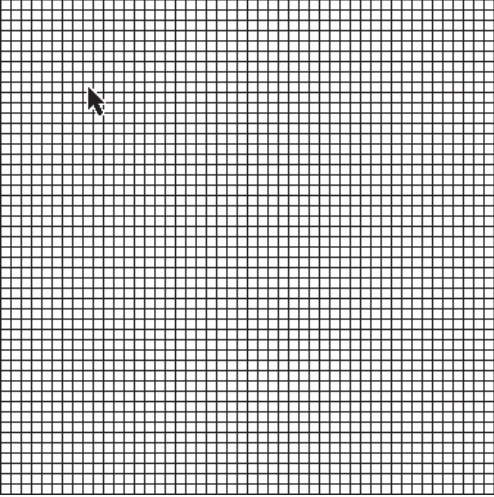
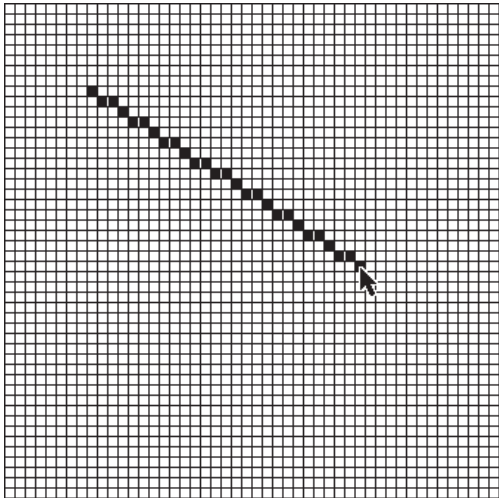

## ■ Freehand Drawing

PROCEDURE	REMARKS
<p>(1) Select the [Draw] menu - [Dot] command, or click on the  icon.</p> <p>(2) Draw a mark by clicking on each dot or by dragging the mouse in the mark drawing area.</p> 	



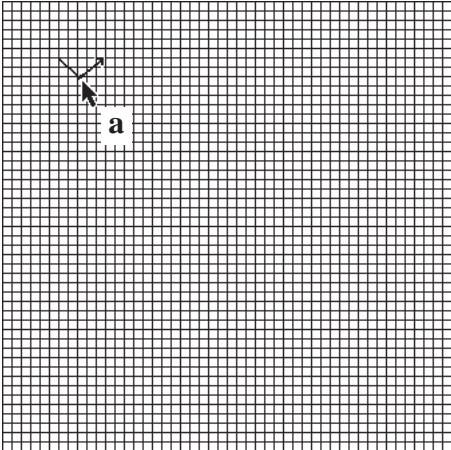
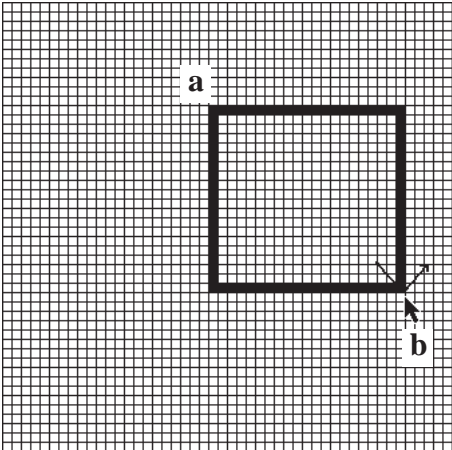

### ■ Drawing a Line

PROCEDURE	REMARKS
<p>(1) Select the [Draw] menu - [Line] command, or click on the  icon.</p> <p>(2) Click on a start point in the mark drawing area and drag the mouse.</p>  <p>(3) Click the end point in the mark drawing area. A line is defined.</p> 	<p>If you press and hold the  key in step (2), you can draw a line at an angle of 0°, 45°, and 90°.</p>

■ Drawing a Square (Rectangle) or Filled Square (Filled Rectangle)

PROCEDURE	REMARKS
<p>(1) Select the [Draw] menu - [Square/Rectangle] or [Filled Square/Rectangle] command, or click on the  or  icon.</p> <p>(2) Click on a point (a) and drag the mouse on a diagonal axis in the mark drawing area.</p> 	
<p>(3) Click on the end point (b). A square or rectangle is defined.</p> 	<p>If you press and hold the  key in step (2), you can draw a square.</p>

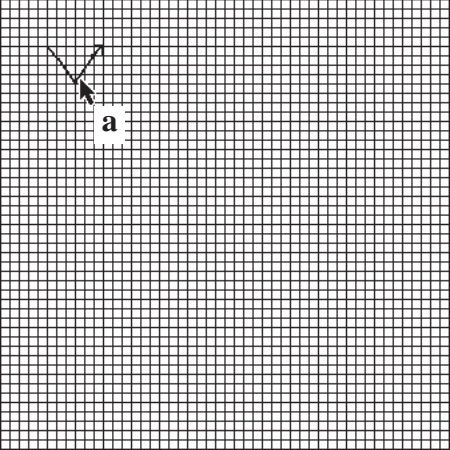
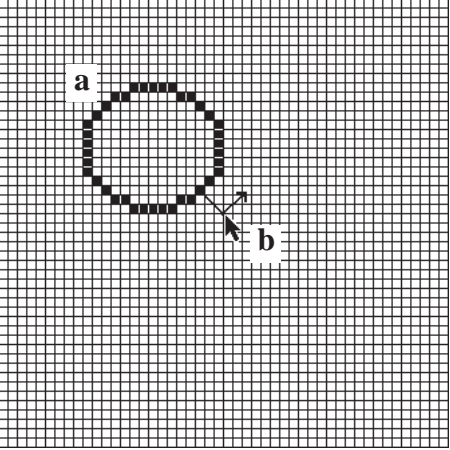
■ Drawing Circle (Oval) or Filled Circle (Filled Oval)

PROCEDURE	REMARKS
<p>(1) Select the [Draw] menu - [Circle/Oval] or [Filled Circle/Filled Oval] command, or click on the  or  icon.</p> <p>(2) Click on a point (a) and drag the mouse on a diagonal axis in the mark drawing area.</p>  <p>(3) Click on the end point (b). A circle or oval is defined.</p> 	<p>If you press and hold the  key in step (2), you can draw a circle.</p>

■ Filling a Mark

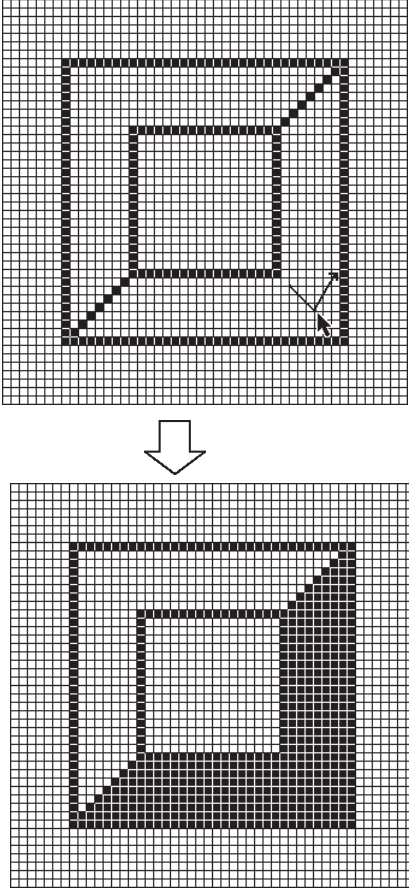
PROCEDURE	REMARKS
<p>(1) Select the [Draw] menu - [Fill] command, or click on the  icon.</p> <p>(2) Click inside the area to be filled. The specified area will be filled.</p> 	<p>If you click on a line, the filling mode cannot be executed. Be sure to click inside a completely enclosed area, if you do not, the entire mark screen may be filled.</p>

■ **Entering Text**

The “Text” mode allows you to enter text on a Mark screen.

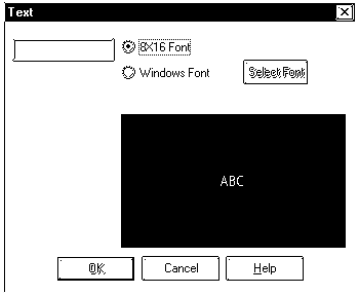
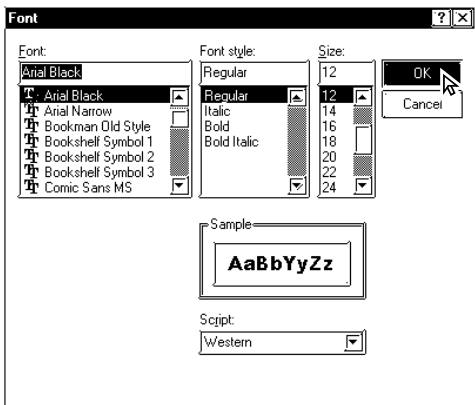
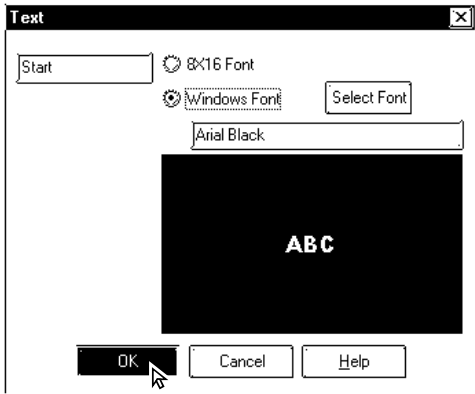
PROCEDURE	REMARKS
<p>(1) Select the [Draw] menu - [Text] command, or click on the  icon.</p> <p>(2) Enter character(s) and select either 8 x 16 dot font or Windows font.</p>  <p>(3) To use the Windows font, click on the <span style="border: 1px solid black; padding: 2px;">Select Font</span> and click on the <span style="border: 1px solid black; padding: 2px;">OK</span> button.</p>  <p>(4) Click on the <span style="border: 1px solid black; padding: 2px;">OK</span> button.</p> <p>An outline corresponding to the entered character(s) will appear.</p> 	

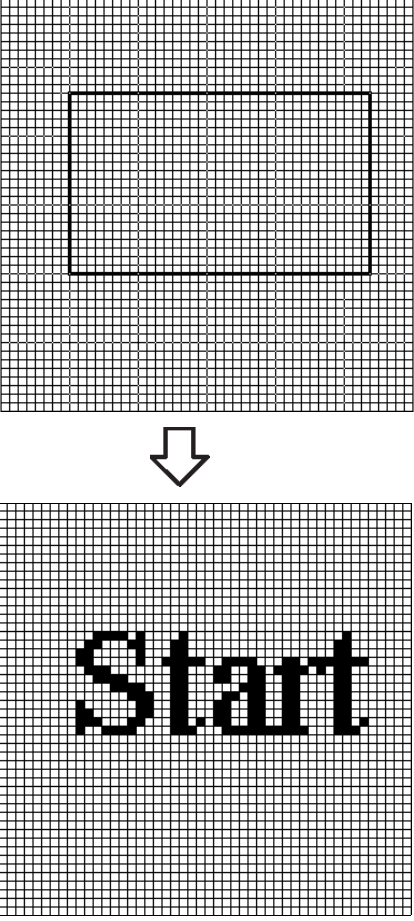

PROCEDURE	REMARKS
<p><b>(5) Move the box to the desired position where the character pattern will be displayed.</b>                      The character pattern is displayed in the position where you click. A Mark can be created using this pattern.</p>  <p>The diagram illustrates the process of creating a mark. It starts with a grid containing a rectangular box. A downward-pointing arrow indicates the next step, where the word 'Start' is displayed in a pixelated font within the grid.</p>	<p>If you move the character pattern to a position where another character pattern has already been created, the new pattern will overwrite the existing pattern, and the existing pattern will be deleted.</p>

**3.1.2 Special Mark Characters**

**■ Creating Special Characters on a Mark screen**

When the European character set has been selected, you can register (create) any kind of the special character you wish. These special characters are handled by Mark screens M8001 to M8128, so up to 128 special characters can be created. The data (characters) on these "special" screens are can then be inserted into any text string, using special reference codes. For example, to call up Mark screen M8001's special character, we need to input the corresponding reference code 80h, and to call up screen M8002, we would enter 81h, etc. However, since these codes are in Hex format, and in GP-PRO/PBIII 's text input mode we can only enter decimal data, we need to use the Hex code's decimal equivalent, shown on the table on page 138.

When any kind of character is "registered" on Mark screens M8001 to M8128, the GP will interpret it as a "special" character. Thus, when the GP encounters one of the abovementioned special reference codes, it automatically searches for the corresponding Mark file. If the file exists (i.e. has been registered and sent to the GP), it replaces its default GP character with the special character Mark.

This feature is useful when you need to change the GP's default character font addresses to match those used by your PC's OS.



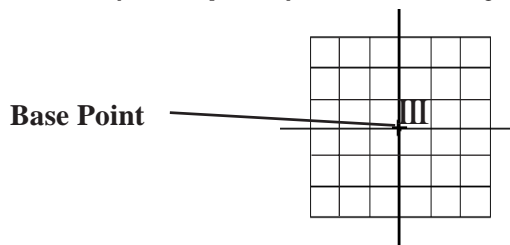

- **The number of special characters that can be used is limited to the number of Mark tags available, i.e 128.**
- **When creating a special character Mark screen, start from point 0,0 (Base point) and use only two 8x8 dot squares.**



**■ Displaying (Calling up) a Special Character**

The method for displaying a registered special character is as follows.

PROCEDURE	REMARKS
<p>The character "III" , previously registered in Mark screen M8010, will be displayed on the GP.</p> <p>(1) Open the Base screen where you want to display the special character, and click on the  icon.</p> 	

PROCEDURE	REMARKS
<p>(2) Hold down the [Alt] key and use your PC's numeric keypad inputting the ASCII code that corresponds to the desired Mark screen.                      The (ASCII) character code that corresponds to screen M8010 is <b>89h</b>, however here, since the code entered must be decimal, enter the corresponding Input code, <b>235</b>. This should cause the character "e" to appear.                      (One application of this special character could be to place it after the text "GP-PRO/PB". In that case, simply enter "GP-PRO/PB" followed immediately by the Input code)</p> <p>(3) After placing this text on the Base screen, saving the screen, and then sending the data (i.e. the Base screen and the Mark file) to the GP, instead of the "ë" character, the Mark screen's "III" will appear.</p>	<div style="text-align: center;">  </div> <p><b>The character displayed, since it is only for reference, will be different from the desired "III". After the Base screen and the Mark file are sent to the GP, the correct character will be automatically displayed.</b></p>



**Characters used by the GP may sometimes differ from those used by GP-PRO/PB III for Windows. Please be sure to check all characters after they are sent to the GP.**

**If the corresponding Mark file is not sent with the Base screen to the GP, the GP will substitute one of its regular characters. (0x80 to 0xFF)**

**Special characters can not be rotated.**

### ■ Character (Reference) Codes

The GP displays characters from the chart shown here. (Code Page 850 character codes)

	0	1	2	3	4	5	6	7	8	9	a	b	c	d	e	f
0	■	■	■	■	■	■	■	■	■	■	■	■	■	■	■	■
1	■	■	■	■	■	■	■	■	■	■	■	■	■	■	■	■
2	!	"	#	\$	%	&	'	(	)	*	+	,	-	.	/	
3	0	1	2	3	4	5	6	7	8	9	:	;	<	=	>	?
4	@	A	B	C	D	E	F	G	H	I	J	K	L	M	N	O
5	P	Q	R	S	T	U	V	W	X	Y	Z	[	\	]	^	_
6	`	a	b	c	d	e	f	g	h	i	j	k	l	m	n	o
7	p	q	r	s	t	u	v	w	x	y	z	{		}	~	■
8	Ç	ü	é	â	ä	à	ç	ê	ë	ì	í	î	ï	Ä	Å	■
9	È	É	Ê	Ë	Ì	Í	Î	Ï	Ï	Ü	Ö	Ø	ƒ	θ	×	f
a	á	í	ó	ú	ñ	Ñ	≡	º	¿	®	¬	½	¼	¡	«	»
b	■	■	■	■	■	■	■	■	■	■	■	■	■	■	■	■
c	Ł	ł	ł	ł	ł	ł	ł	ł	ł	ł	ł	ł	ł	ł	ł	ł
d	Š	š	Š	š	Š	š	Š	š	Š	š	Š	š	Š	š	Š	š
e	Ó	õ	Ô	ò	õ	Õ	µ	£	₧	Ú	Û	Ü	Ý	Ÿ	'	■
f	-	±	=	¼	¾	⁄	÷	·	°	²	³	⁴	⁵	⁶	⁷	⁸

89h = ë

### ■ Hex/Decimal Corresponding Character Codes

When inputting reference codes for special Mark screens, use the chart below.



Mark Screen	Char Code Code Page 850	Input Code (ALT+code)	Char Code Code Page 850	Input Code (ALT+code)	Char Code Code Page 850	Input Code (ALT+code)
M8001	80h	0199	B0h	0130	E0h	0211
M8002	81h	0252	B1h	0131	E1h	0223
M8003	82h	0233	B2h	0132	E2h	0212
M8004	83h	0226	B3h	0133	E3h	0210
M8005	84h	0228	B4h	0134	E4h	0245
M8006	85h	0224	B5h	0193	E5h	0213
M8007	86h	0229	B6h	0194	E6h	0181
M8008	87h	0231	B7h	0192	E7h	0254
M8009	88h	0234	B8h	0169	E8h	0222
M8010	89h	0235	B9h	0135	E9h	0218
•	8Ah	0232	BAh	0136	EAh	0219
•	8Bh	0239	BBh	0137	EBh	0217
•	8Ch	0238	BCh	0138	ECh	0253
•	8Dh	0236	BDh	0162	EDh	0221
	8Eh	0196	BEh	0165	EEh	0175
	8Fh	0197	BFh	0139	EFh	0180
	90h	0201	C0h	0140	F0h	0173
	91h	0230	C1h	0141	F1h	0177
	92h	0198	C2h	0142	F2h	0159
	93h	0244	C3h	0143	F3h	0190
	94h	0246	C4h	0144	F4h	0182
	95h	0242	C5h	0145	F5h	0167
	96h	0251	C6h	0227	F6h	0215
	97h	0249	C7h	0195	F7h	0184
	98h	0255	C8h	0146	F8h	0176
	99h	0214	C9h	0147	F9h	0168
	9Ah	0220	CAh	0148	FAh	0183
	9Bh	0248	CBh	0149	FBh	0185
	9Ch	0163	CCh	0150	FCh	0179
	9Dh	0216	CDh	0151	FDh	0178
	9Eh	0128	CEh	0152	FEh	0247
	9Fh	0129	CFh	0164	FFh	0160
	A0h	0225	D0h	0240		
	A1h	0237	D1h	0208		
	A2h	0243	D2h	0202		
	A3h	0250	D3h	0203		
	A4h	0241	D4h	0200		
	A5h	0209	D5h	0153		
	A6h	0170	D6h	0205		
	A7h	0186	D7h	0206		
	A8h	0191	D8h	0207		
	A9h	0174	D9h	0154		
	AAh	0172	DAh	0155		
	ABh	0189	DBh	0156		
	ACh	0188	DCh	0157		
	ADh	0161	DDh	0166		
	A Eh	0171	DEh	0204		
	AFh	0187	DFh	0158		

**3.1.3 Editing a Mark**

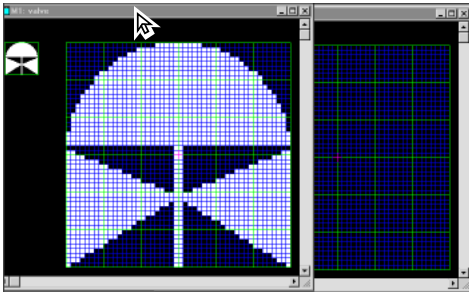

To edit a mark, you can use the following editing functions. This section describes the operating procedure for each function.

■ **Cutting a Mark**

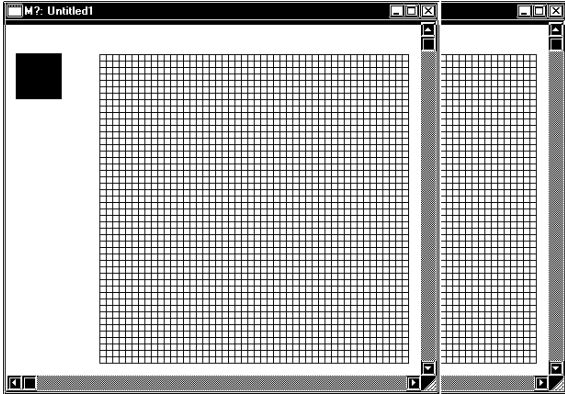
The “Cut” command deletes the data of the selected screen and stores it in the clipboard\*1. (The deleted screen can be moved to another screen, but cannot be moved to the original screen.) The “Cut” command can be executed for the entire screen.

PROCEDURE	REMARKS
<p><b>(1) Select the original Mark screen to be cut.</b>                      This description assumes that several screens have already been opened.</p> 	
<p><b>(2) Select the [Edit] menu - [Cut] command, or click on the  icon to store the Mark data in the Clipboard.</b>                      Data of the original data screen will be cut.</p> 	<p>To delete the Mark screen, perform steps (1) and (2) only.</p>

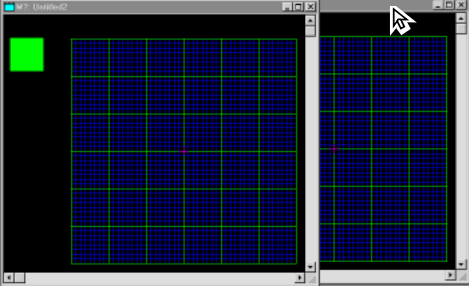
\*1 When the [Copy] or [Cut] command is executed, the copied or cut data are temporarily stored in the clipboard.  
 When you execute the [Paste] command, the data stored in the clipboard will be pasted to the selected position.

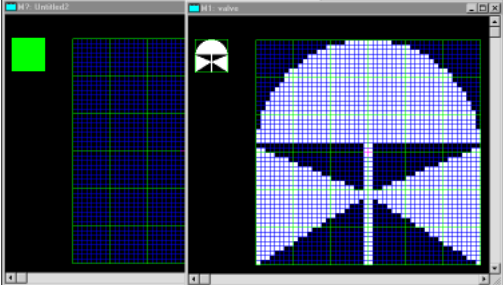



PROCEDURE	REMARKS
<p>(3) Select the mark screen (destination) to which the selected Mark screen will be pasted.</p>  <p>(4) Select the [Edit] menu - [Paste] command, or click on the  icon. Data of the Mark screen will be pasted.</p> 	

■ **Copying a Screen**

The selected screen data are copied in the clipboard. Unlike the [Cut] command, the original screen data will not be deleted.

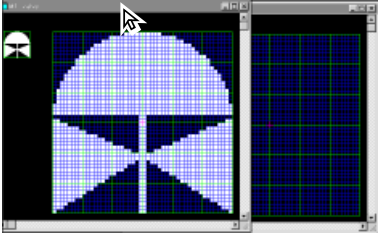

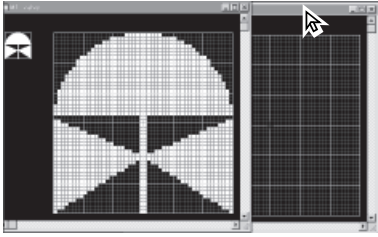

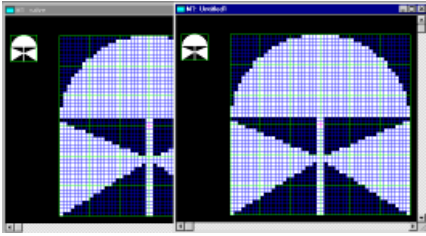
To copy a mark into the original screen, use the [Duplicate] command.

PROCEDURE	REMARKS
<p>(1) <b>Select the original Mark screen to be copied.</b>                      This description assumes that several screens have already been opened.</p>  <p>(2) Select the [Edit] menu - [Copy] command, or click on the  icon to store the mark in the Clipboard.</p> <p>(3) Select the mark screen (destination) to which the selected Mark screen will be copied.</p>  <p>(4) Select the [Edit] menu - [Paste] command, or click on the  icon.                      Data will be copied from the original Mark screen and pasted onto the destination Mark screen.</p> 	

■ Copying a Specified Range : Duplication

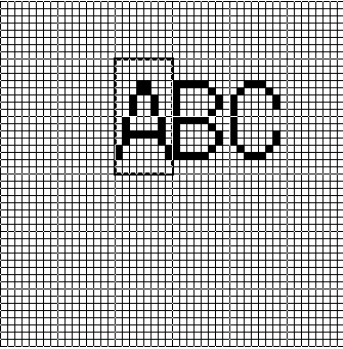
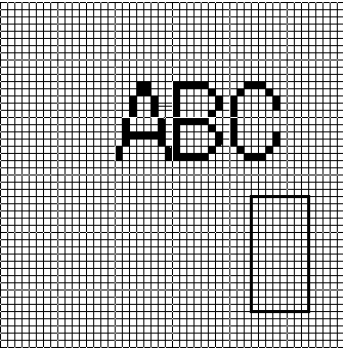
A specified range in the mark drawing area can be duplicated by dots.

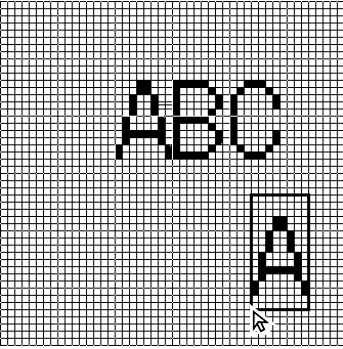
PROCEDURE	REMARKS
<p>(1) Select the [Edit] menu - [Duplicate] command, or click on the  icon.</p> <p>(2) Specify the copy range in the same manner as drawing a square/rectangle. A box appears, indicating the specified copy range.</p> 	
<p>(3) Move the box to a desired position where the data in the specified range will be copied. Data in the specified range will be copied to the position where you click.</p> 	<p> <b>Important</b> <i>If you copy a mark into the position where another mark has already been created, the new data will overwrite the existing data, and the existing data will be deleted.</i></p> <p>You can continue the copy mode until you click the right mouse button.</p>
<p>(4) To quit the copy mode, click the right mouse button.</p> 	



■ **Deleting a Mark**

Delete the mark, a partion of it.

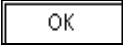
PROCEDURE	REMARKS
<p>(1) Select the [Edit] menu - [Delete] command, or click on the  icon.</p> <p>The procedures for deleting part of a mark or deleting a whole mark are separately described:</p> <p><b>[Deleting Part of a Mark]</b></p> <p>(2) Select [Partial Clear] and click on the  button.</p> <div data-bbox="263 734 651 987" data-label="Image"> </div> <p>(3) Specify the range to be deleted in the same manner as drawing a square/rectangle.</p> <div data-bbox="263 1128 715 1579" data-label="Image"> </div>	

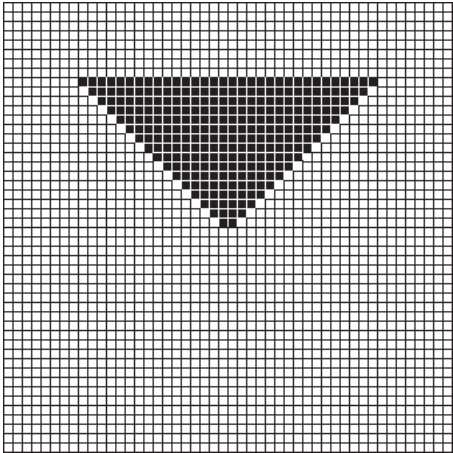
PROCEDURE	REMARKS
<p><b>(4) Click in the range to be deleted.</b> The specified range will be deleted.</p> 	

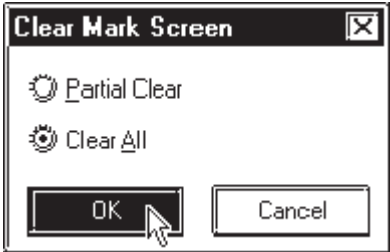
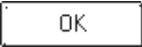
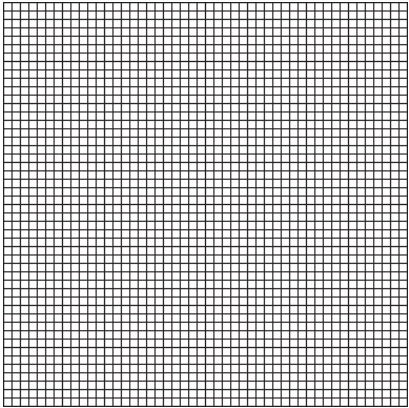
PROCEDURE	REMARKS
<p><b>[Deleting the Entire Mark]</b></p> <p><b>(2) Select [Clear All].</b></p>  <p><b>(3) Click on the  button to delete the entire mark.</b> The entire mark will be deleted.</p> 	

■ **Mirror X, Mirror Y**

The “Mirror X” and “Mirror Y” functions move a mark symmetrically relative to the vertical and horizontal axis, respectively.

To execute the “Mirror X” and “Mirror Y” functions, click on the   icon, respectively.

Example) Mirror X

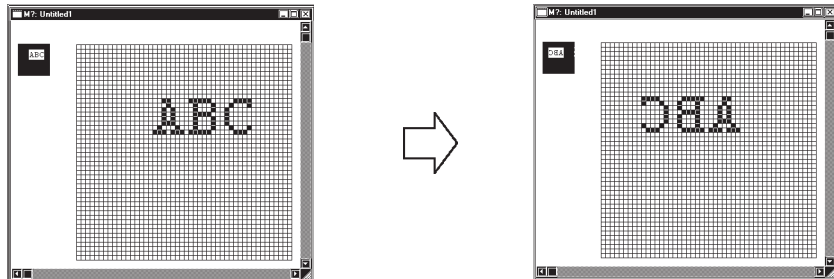

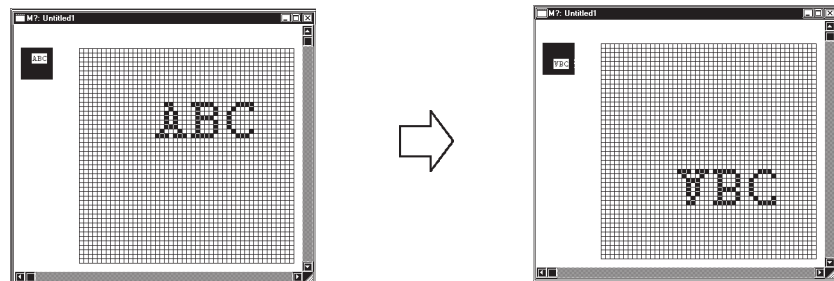

Example) Mirror Y



■ **Turn Counterclockwise [O], Turn Clockwise [N]**

The “Turn Counterclockwise”, “Turn Clockwise” functions turn the mark counterclockwise and clockwise 90°, respectively.

To execute the “Turn Counterclockwise” and “Turn Clockwise” functions, click on their respective the   icons respectively.

Example) Turn Counterclockwise

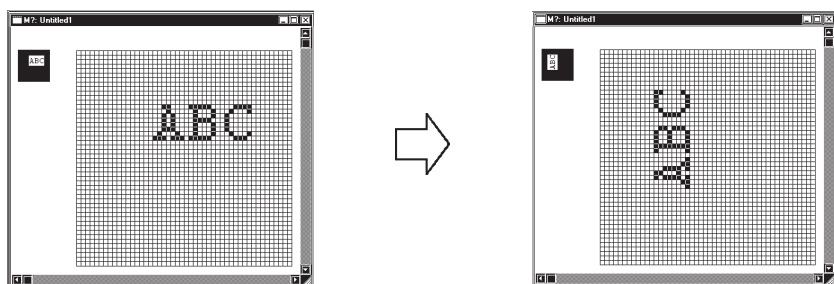

Example) Turn Clockwise

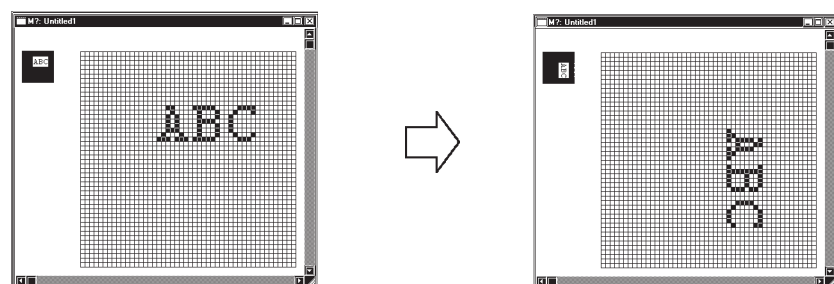

**■ Reverse**

This function reverses the white and black areas. In the reverse display mode, all ON dots are turned OFF, and all OFF-dots are turned ON.

To execute this function, click on the  icon.

Example)

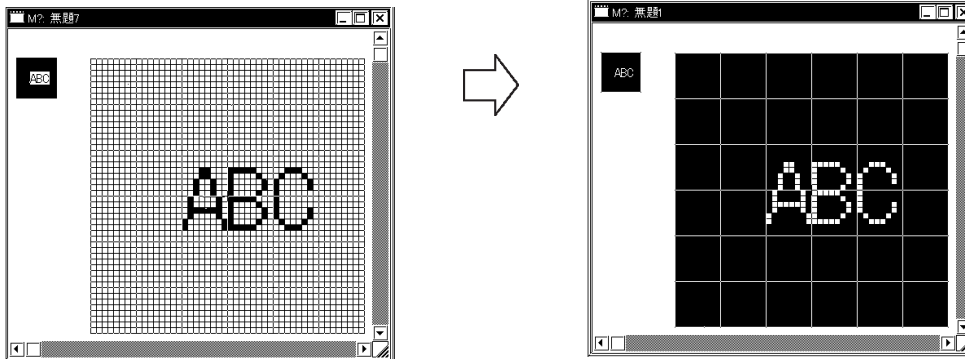

■ **Transparent/Background Color**

If no dots are turned ON in a block, this block becomes transparent. When this function is set to “Background color”, a block without any ON dots is displayed in the background color (Bg).

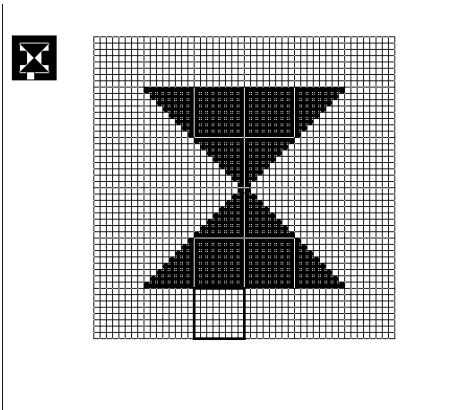
PROCEDURE	REMARKS
<p>(1) Select the [Edit] menu - [Background Color] command, or click on the  icon.</p> <p>(2) Click in the block to be displayed in the background color. The border line of the specified block is changed. Every time you click in the block, the color setting is switched.</p> <div style="border: 1px solid black; padding: 10px; margin: 10px 0;">  </div> <p>(3) Click the right mouse button to register the above setting.</p>	

■ **Display When Called Up to a B (Base) Screen**

When this function is set to “Transparent”:

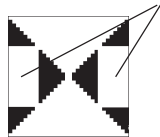
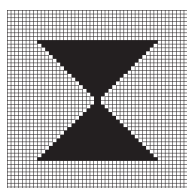

These blocks contain no ON-dots.

If at least one dot is ON in a block, this block is displayed in the background color. The block with no ON dots becomes transparent, and you can see the objects on the base screen.

When this function is set to “Background color”:

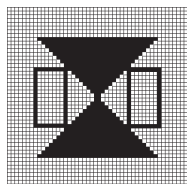

The block with no ON dots is displayed in the background color.

**■ Canceling a Command: Undo**

This function is used to cancel a command and return to the previous condition immediately before the command was made.

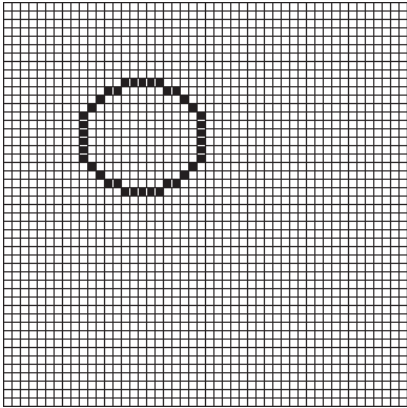

[Undo] is only effective for the command immediately before it.

PROCEDURE	REMARKS
<p>After deleting a circle unintentionally:</p> <p>(1) Select the  icon.</p> <p>The deleted circle is restored, and the screen returns to the previous condition.</p> 	

**■ Redo Command**

This function is used to redo the command canceled with the [Undo] command.

The [Redo] command is effective only for the command immediately before it.

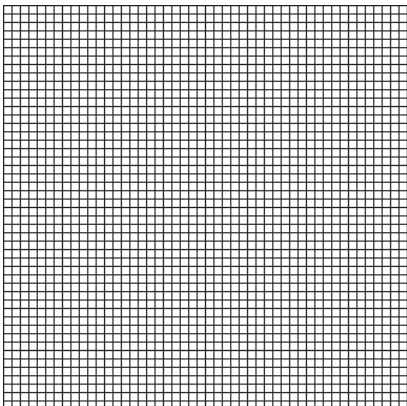
PROCEDURE	REMARKS
<p>After deleting a circle, you have selected the  icon to return to the previous condition, but you realize that actually, the circle must be deleted:</p> <p>(1) Select the  icon.</p> <p>The screen returns to the condition where the circle has been deleted and harmony is restored.</p> 	

### 3.1.4 Registering and Placing a Mark Library Item

You can register a mark created in the mark drawing area and the registered mark can be loaded whenever required. The Mark Library Item (mark list) can be saved as a mark library file (MRK file). The GP-PRO/PB III enables you to manage MRK files independent of project (PRW) files. This function allows you to use the same mark for several projects, since you can select a desired mark while checking the image displayed in the browser. Registration, placement, and other editing operations of Mark Library are performed in the same manners as those of the standard Libraries.

**Reference** *2.5 Libraries*



**Note:** GP-PRO/PB III for Windows has pre-made MRK files in correspondence with the ISO7000 Series marks and symbols.

**Reference** *Parts List Manual*





Drawing symbol number	MRK file name	Title
0001-0200	IS07-1	0001-0200
0201-0400	IS07-2	0201-0400
0401-0600	IS07-3	0401-0600
0601-0800	IS07-4	0601-0800
0801-1000	IS07-5	0801-1000
1001-1140	IS07-6	1001-1140

## 3.2 Creating a Trend Graph: the Trend Graph Screen



You can create a trend graph with the Trend Graph screen. Using the [Draw] menu - [Load Screen] command, you can load a trend graph from the Trend Graph screen onto a Base screen. The specified loading point is placed at the center of the screen. Up to eight Trend Graph screens can be loaded onto one Base screen.

**Note:** A maximum of eight Trend Graph screens can be loaded onto each Base screen. However, only one trend graph with the Data Record Display function can be loaded.

**Reference** For details of the Data Record Display function, refer to *Tag Reference Manual, 2.31 Trend Graph Display.*

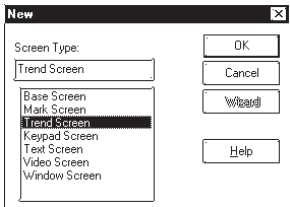

Usage Pattern			
Open a Trend Graph screen by selecting the <b>[Screen]</b> menu <b>[New]</b> command, or by clicking on the  icon.	→	Draw the graph axis and scales by using the drawing tool.	
→ Set the screen by selecting the <b>[Tag]</b> menu - <b>[Set Screen]</b> command, or by clicking on the  icon.	→	Set the channel by selecting the <b>[Tag]</b> menu - <b>[Set Channel]</b> command, or by clicking on the  icon.	→ Save the Trend Graph screen.
Open a Base screen <b>[Draw]</b> →	<b>[Draw]</b> →	<b>[Load Screen]</b> or Click on  to call up a Trend Graph.	→ The selected Trend Graph screen will be displayed on the Base screen.

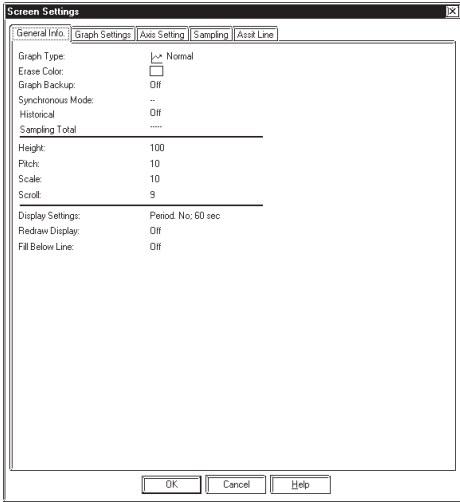
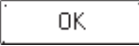
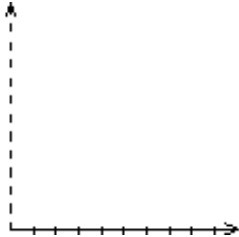
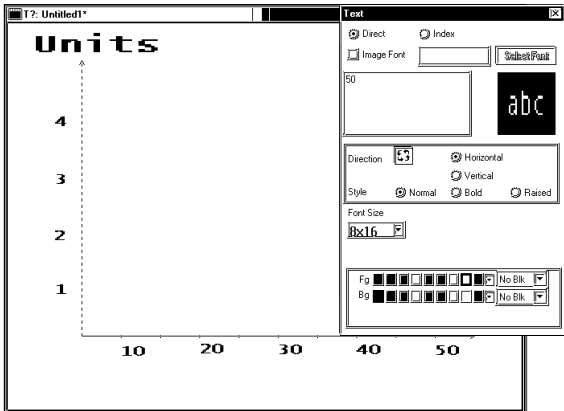

### ■ Creating a Trend Graph

PROCEDURE	REMARKS
<p>(1) Select the [Screen] menu - [New] command, or click on the  icon.</p> <p>(2) Select a Trend Graph screen.</p>  <p>(3) Select the [Tag] menu - [Set Screen] command, or click on the  icon.</p>	<p><b>Reference</b> <i>1.1.3 Opening/Closing/Saving a Screen</i></p>

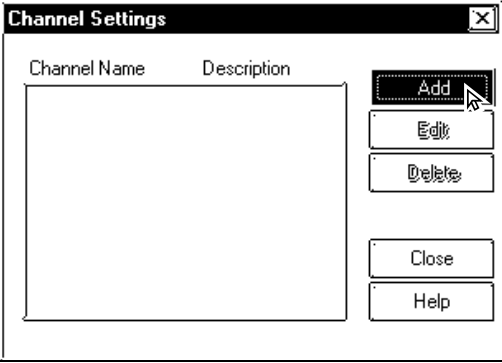
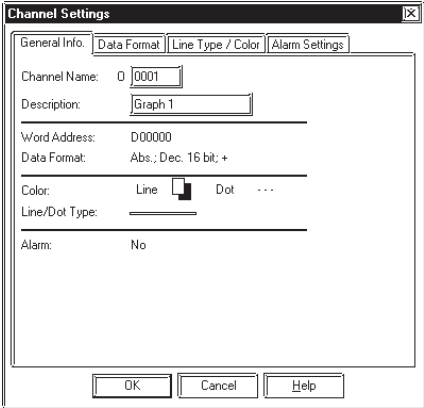
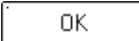
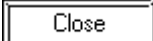
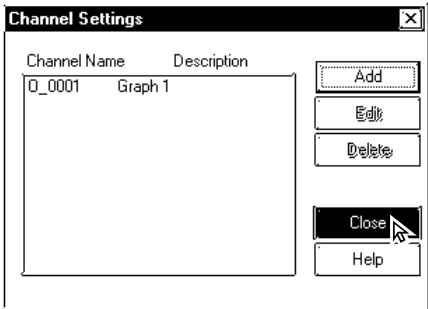

PROCEDURE	REMARKS
<p>(4) Set the parameters for the [Screen Settings] screen.</p> 	<p>The effective setting range of the “pitch”, “Number of display data” and “Scroll” parameters for the [Set Screen] command varies depending on the setting values. Be sure to set these parameters.</p> <p><b>Reference</b> <i>Tag Reference Manual, 2.31 Trend Graph Display</i></p> <p>Trend Graph Display Setting Origin, 100% of height and pitch</p>
<p>(5) After setting all items, click on the  button to register the above settings.</p> <p>The graph display area is displayed with handles in the drawing area. Change the size and position of the graph display area, as required.</p> 	<p><b>Reference</b> <i>2.4 Object Editing</i></p>
<p>(6) Draw the graph axis and scales.</p> 	<p><b>Reference</b> <i>2.2 Drawing</i></p> <p><b>Reference</b> <i>2.4 Object Editing</i></p> <p>Draw the graph axis and scales outside the graph display area so that they will not overlap with the graph display area. If the graph axis and scales are placed in the graph display area, they cannot be displayed when the Trend Graph screen is operated on the GP series' panel.</p> <p>To display the graph axis and scales on the screen, select the [Screen Property] command from the pull down [Option] menu and enable the Tag Mark display.</p>

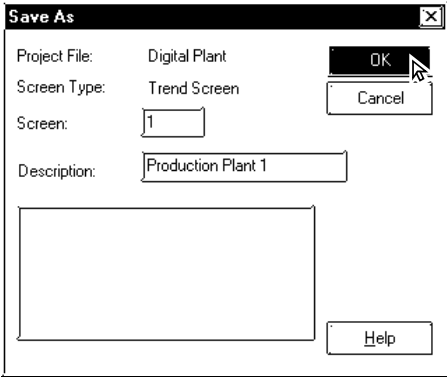

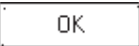
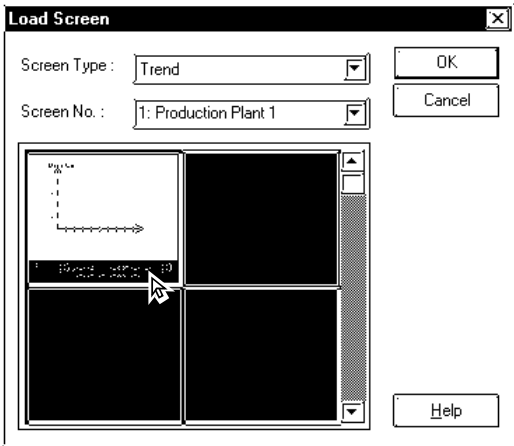
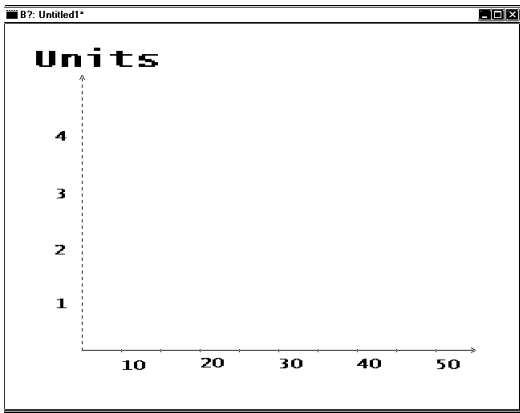

PROCEDURE	REMARKS
<p>(7) Select the [Tag] menu - [Set Channel] command, or click on the  icon.</p> <p>(8) Click on the  button in the [Channel Settings] dialog box.</p>  <p>(9) Designate [Channel Settings]' each item.</p>  <p>(10) After setting all items, click on the  button to register the settings. To display several trend graphs in the same graph display area, repeat the above procedure from step (7).</p> <p>(11) Click on the  button to close the [Channel Settings] dialog box.</p> 	<p>Each function of the trend graph display is called “Channel” instead of “Tag”.</p> <p>To specify a channel name, you can use up to five characters (including alphanumerics and symbols.)</p> <p>To specify a channel’s description, you can use up to twenty characters.</p> <p>The number of channels of Trend Graphs, including the number of channels of Data Sampling, that can be set up for the entire Project is 40 with the GP2000 series and 20 with other models.</p> <p><b>Reference</b> <i>Tag Reference Manual, 2.31 Trend Graph Display</i></p>

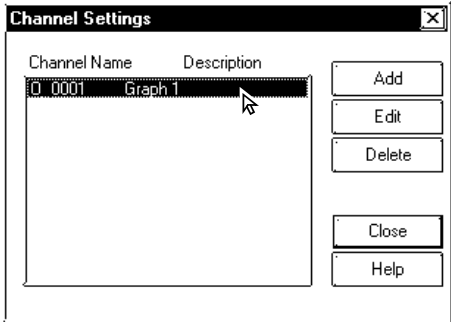
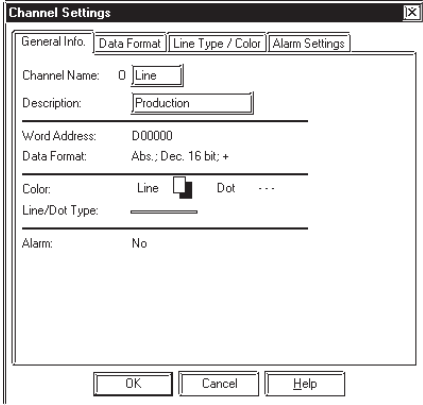
PROCEDURE	REMARKS
<p>(12) After setting all items, save the Trend Graph screen.</p> 	<p><b>Reference</b> 1.1.3 ■ Saving a Screen</p>
<p>(13) Open a Base screen. Then, select the [Draw] menu - [Load Screen] command, or click on the  icon to call up a Trend Graph screen.</p>	<p><b>Reference</b> 2.2.10 Load Screens</p>
<p>(14) Select a screen you want to call up from the list, and then click on the  button.</p> 	
<p>(15) The selected screen will be placed in the position you have clicked on.</p> 	

■ Editing a Channel

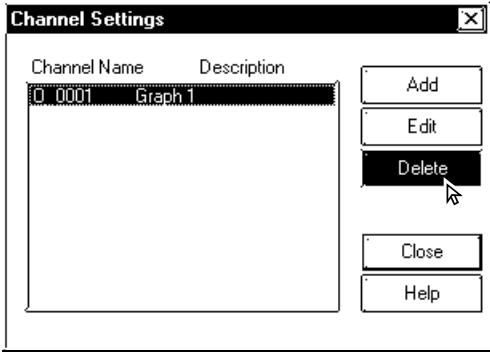
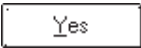
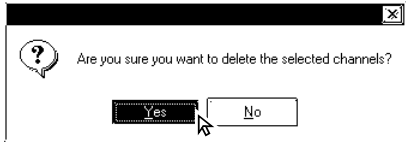
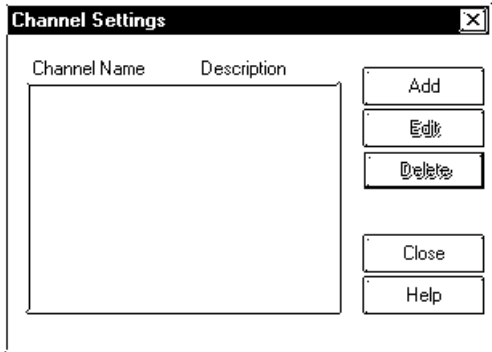
PROCEDURE	REMARKS
<p>(1) Select the channel to be edited.</p> 	<p>To select several channels, click on the channel names while pressing the <b>Shift</b> key.</p> <p>To select an individual channel, click on the channel name while pressing the <b>Ctrl</b> key.</p>
<p>(2) Click on the <b>Edit</b> button.</p> <p>The setting item dialog box will be opened, enabling you to edit the channel.</p> 	

■ Deleting a channel

PROCEDURE	REMARKS
<p>(1) Select a channel you wish to delete and click on the  button.</p>  <p>(2) Click on the  button.</p>  <p style="text-align: center;">↓</p> 	<p>To select several channels, click on the channel names while pressing the  key.</p> <p>To select an individual channel, click on the channel name while pressing the  key.</p> <p> <b>Important</b> Once the [Delete] command is executed, the deleted channel cannot be restored.</p>

# 3.3 Creating a Keypad: the Keypad Screen

You can create a keyboard with the Keypad screen. Using the Base screen's [Draw | Load Screen] command allows you to load a keypad from the Keypad screen onto a Base screen. When the Keypad screen is loaded, the specified loading point is placed at the center of the screen.

**Reference** 2.2.10 Load Screens

The GP-PRO/PB III provides several sample keyboards. Using the sample keyboards, there is no need to create a keyboard on each screen.

**Reference** 3.3 Application of Sample Keypads

To use a keypad Part, place it on a Base screen directly.

**Reference** 2.1.13 Keypads

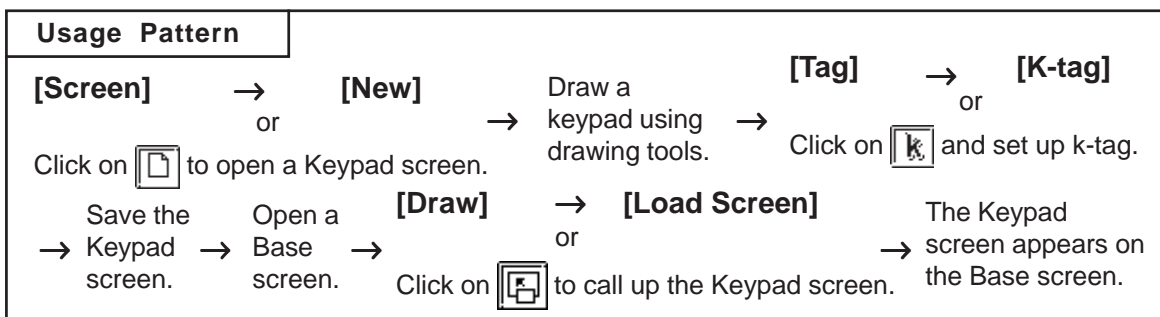

### Creating a Keypad

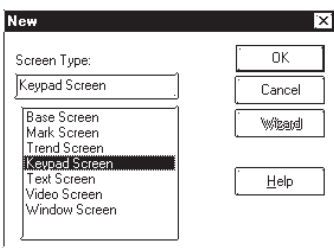
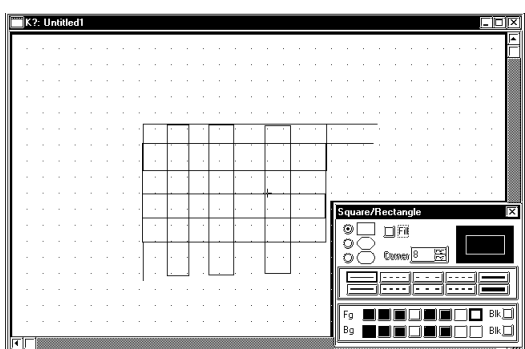
PROCEDURE	REMARKS
<p>(1) Select the [Screen] menu - [New] command, or click on the  icon.</p> <p>(2) Open a Keypad screen.</p>  <p>(3) Draw a keypad.</p> 	<p><b>Reference</b> 1.1.3 Opening/Closing/Saving a Screen</p> <p><b>Reference</b> 2.2 Drawing</p>

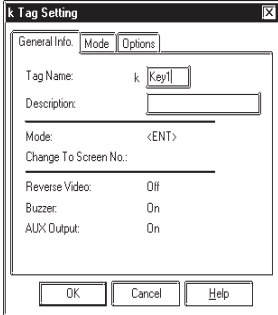
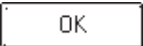
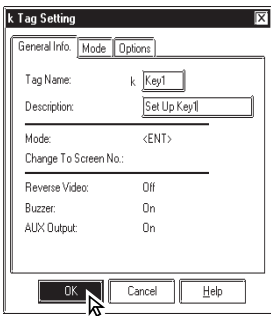
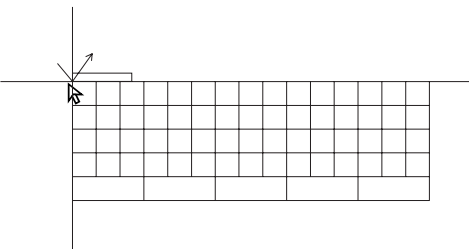
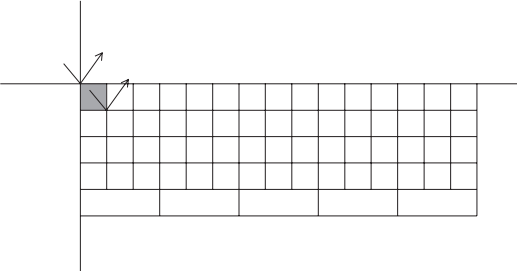
PROCEDURE	REMARKS
<p>(4) Select the [Tag] menu - [k-tag] command, or click on the  icon.</p> 	
<p>(5) Enter or designate k-tag's each setting item.</p>	
<p>(6) After setting all items, click on the  button to register the settings.</p> 	<p>To specify a tag name, you can use up to five characters (including alphanumerics, symbols and “Double-sized” characters.)</p> <p><b>Reference</b> <i>Tag Reference Manual, 2.12 K-tag (Key Input)</i></p>
<p>(7) Specify the tag name position by clicking on a desired point.</p> 	
<p>(8) Specify the touch area (where the specified tag will be activated) in the same manner as drawing a square/rectangle. Repeat steps (4) through (8) to set the k-tag for all keys.</p> 	<p>To specify a channel name, you can use up to twenty characters.</p> <p>Specify the touch area so that it will not overlap with the touch area of another tag.</p>

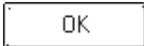
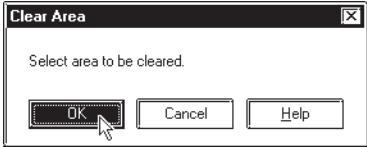
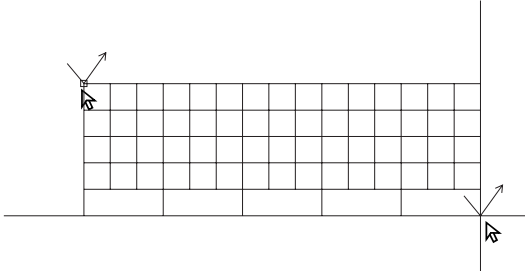
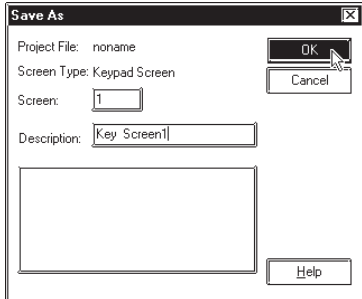
PROCEDURE	REMARKS
<p>The “screen switching function” of the k-tag enables you to replace the keypad display area with another keyboard screen.</p> <p>To use this function, set the [Clear Area].</p> <p>To replace the keyboard screen, start the procedure from step (9). Otherwise, start the procedure from step (12).</p> <p><b>(9) Select the [Tag] menu - [Clear Area] command, or click on the  icon.</b></p> <p><b>(10) Click on the  button.</b></p>  <p><b>(11) Specify the area to be cleared in the same manner as drawing a square/rectangle.</b></p> <p>Load the keypad to be replaced, and specify the display area. In this example, the entire keypad display area is specified.</p>  <p><b>(12) After completing the above settings, save the keypad screen.</b></p> 	<p><b>Reference</b> 1.1.3 Opening/Closing/Saving a Screen</p>



### ■ Application of Sample Keypads

Several sample keypads (files created with the GP-PRO III) are provided in the “KEYLIB” folder below the folder (C:\PROPBWIN) where the GP-PRO/PB III has been installed. You can use the sample keypads, and also edit them to create a new keypad. To use the sample keypads, load the keypad screens (files created with the GP-PRO III) into the current project.



**Note:** Instead of the sample keypads, keypad Parts can also be used.

#### ▼ Reference ▲ 2.1.13 Keypads

The following is the general procedure for using the sample keyboards:

- (1) Load a file of the memory link type (K8\*\*\*.DLM) from “C:\PROPBWIN\KEYLIB” into the current project. Load the necessary keyboard screen from “C:\PROPBWIN\KEYLIB” into the current project.

#### ▼ Reference ▲ 12.1.1 Conversion from GP-PRO II or GP-PRO III

- (2) Open a keypad screen and edit the screen, as required.

#### ▼ Reference ▲ 1.1.3 ■ Opening a New Screen

The following sample keypads are provided:

File name	Keyboard shape and input mode
K8000.DLM	T en-keypad, Decimal input
K8001.DLM	T en-keypad, Hexadecimal input
K8002.DLM	T en-keypad, Control keys, Horizontal
K8003.DLM	Full keys, Horizontal, Numbers
K8004.DLM	Full keys, Horizontal, Symbols
K8005.DLM	Full keys, Horizontal, Uppercase alphabet
K8006.DLM	Full keys, Horizontal, Lowercase alphabet
K8009.DLM	Full keys, Horizontal, Basic type
K8010.DLM	T en-keypad, Control keys, Vertical
K8011.DLM	Full keys, Vertical, Numbers
K8012.DLM	Full keys, Vertical, Symbols
K8013.DLM	Full keys, Vertical, Uppercase alphabet
K8014.DLM	Full keys, Vertical, Lowercase alphabet
K8017.DLM	Full keys, Vertical, Basic type

Example) K8000

△	▽	←	→
7	8	9	DEL
4	5	6	-
1	2	3	E
0	.	CLR	N
			T

Ten-key pad,  
Decimal input

Example) K8007

a	b	c	d	e	f	g	h	i	j	k	NUM	EU	EL	EC1	EC2
l	m	n	o	p	q	r	s	t	u	SG1	SG2	←	→	△	▽
v	w	x	y	z	-	.	,	'	/	SP	BS	DEL	CLR	ENT	

Full keys, Horizontal, Lowercase Alphabets

Example) K8013

A	B	C	D	E
F	G	H	I	J
K	L	M	N	O
P	Q	R	S	T
U	V	W	X	Y
Z	-	.	,	'
SG1	/			SP
SG2	EU	EL	EC1	EC2
NUM	←	→	△	▽
BS	DEL	CLR	ENT	

Full keys, Vertical,  
Uppercase alphabets

# 3.4 Text Input: the Text Screen

Create text data on the GP-PRO/PBIII text (X) screen. You can paste text data created with another editor onto the GP-PRO/PBIII text (X) screen using the [Cut] or [Copy] command.

The created text data can also be animated; there are two methods: Displaying text by a specified number of lines (specified by X-tag), and a list with error guidance (specified by A-tag).

**Reference** *Tag Reference Manual, 2.1 A-tag (Alarm Summary TEXT Display)/ 2.30 X-tag (Display Text Data)*

This feature allows you to export text data created with GP-PRO/PBIII as a .csv or .txt file, or import the same types of data to a GP-PRO/PBIII text (X) screen.

**Reference** *3.4.3 Text Screen Import and Export*

Also, you can edit text screens used for Multi-language text display.

**Reference** *3.4.2 Editing Multilanguage Text Screens, and 4.6 String Table Editor*



- Text screens compatible with the Multi-language display feature can be edited only on the GP2000 Series units.





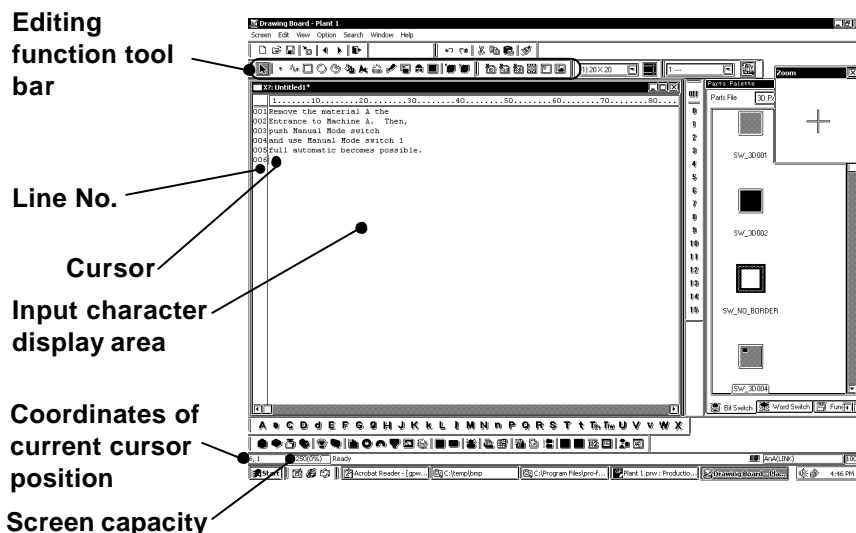

Usage Pattern			
[Screen] <sup>Ⓡ</sup>	[New]	Open	Quit the
or		a Text	GP Text
Click on		screen.	Editor.
		Enter text.	Save the
			Text
			screen.

General description of the Text screen:



## ■ Editing Functions

The Editing Tool Bar icons and their corresponding functions are as follows:



Icon	Editing Tool	Description
	<b>Cut</b>	Used to delete the selected text, and store it in the clipboard. You can use this function to delete or move text.
	<b>Copy</b>	Used to store the selected text in the clipboard. Unlike the [Cut] command, the original text will not be deleted.
	<b>Paste</b>	Used to paste the data temporarily stored in the clipboard onto a desired place.
	<b>Delete</b>	Used to delete the selected text.
	<b>Undo</b>	Used to cancel the command executed immediately before, and return to the previous condition. (Undo)
	<b>Redo</b>	Used to redo the command canceled with the [Undo] command. (Redo)

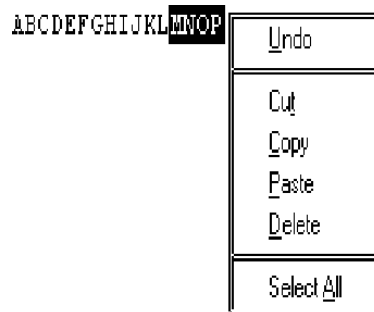

- When you select characters and click the right mouse button, the following shortcut menu appears.

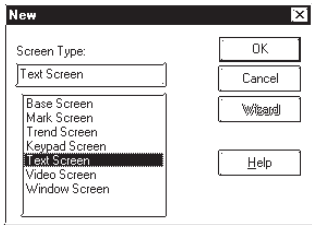

■ Input the Text

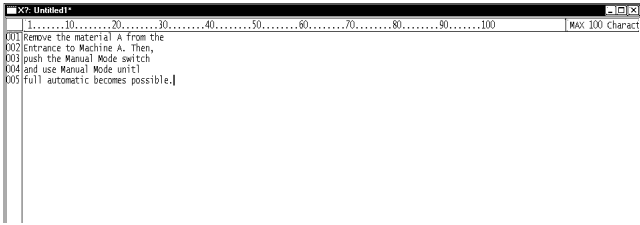
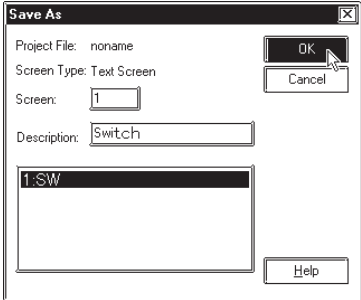



PROCEDURE	REMARKS								
<p>(1) Select the [Screen] menu - [New] command, or click on the  icon to open a Text screen.</p> <p>(2) Open a Text screen.</p>  <p>(3) Enter text in the text display area through the keyboard.</p> <p>Be sure to press the [Enter] key  at the end of each line.</p>  <p>(4) After entering text, save the Text screen.</p> 	<p><b>Reference 1.1.3 ■ Opening a New Screen</b></p> <table border="1"> <thead> <tr> <th>Maximum number of characters</th> <th>GP Type</th> </tr> </thead> <tbody> <tr> <td>40</td> <td>GP-H70, GP-270, GP-370, GP-377, GP-37W2, GP-377R, GP-2301H, GP-2300, GP-2301</td> </tr> <tr> <td>80</td> <td>GP-470, GP-570, GP-571, GP-870, GP-477R, GP-577R, GP-2401H, GP-2400, GP-2401, GP-2500, GP-2501</td> </tr> <tr> <td>100</td> <td>GP-675, GP-2600, GP-2601</td> </tr> </tbody> </table> <p>You can enter up to 512 lines on one screen. Line number 513 or subsequent lines cannot be displayed.</p>	Maximum number of characters	GP Type	40	GP-H70, GP-270, GP-370, GP-377, GP-37W2, GP-377R, GP-2301H, GP-2300, GP-2301	80	GP-470, GP-570, GP-571, GP-870, GP-477R, GP-577R, GP-2401H, GP-2400, GP-2401, GP-2500, GP-2501	100	GP-675, GP-2600, GP-2601
Maximum number of characters	GP Type								
40	GP-H70, GP-270, GP-370, GP-377, GP-37W2, GP-377R, GP-2301H, GP-2300, GP-2301								
80	GP-470, GP-570, GP-571, GP-870, GP-477R, GP-577R, GP-2401H, GP-2400, GP-2401, GP-2500, GP-2501								
100	GP-675, GP-2600, GP-2601								

**3.4.1 Editing Text**

The GP-PRO/PB III provides the Cut, Copy, and Paste functions to edit text data. These functions improve your editing efficiency.

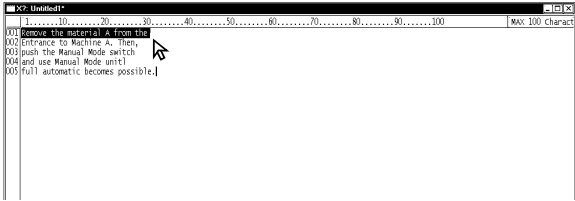
**■ Cutting/Pasting Text**

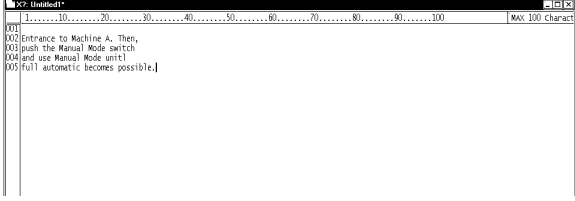

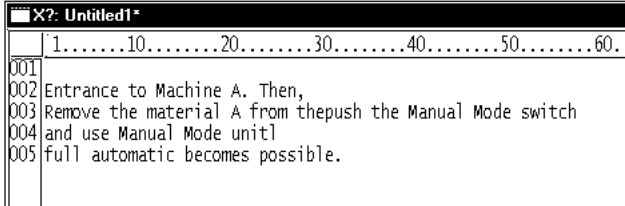
This function is used to delete selected text and store it in the clipboard\*1. You can copy the text onto a desired position using the [Paste] command.

PROCEDURE	REMARKS
<p><b>(1) Select the text to be cut.</b></p>  <p>The screenshot shows a text editor window titled 'X?: Untitled1*'. The text content is:         <pre>001 Remove the material A from the 002 Entrance to Machine A. Then, 003 push the Manual Mode switch 004 and use Manual Mode unit 005 full automatic becomes possible.</pre>         A mouse cursor is positioned over the text 'Remove the material A from the', which is highlighted in black, indicating it has been selected.         </p>	<p>To select several characters, drag the mouse within a desired text range.</p> <p>To select all the text, select the [Edit] menu - [Select All] command.</p>
<p><b>(2) Select the [Edit] menu - [Cut] command, or click on the  icon.</b> The selected characters will be temporarily cut.</p>  <p>The screenshot shows the same text editor window. The text content is:         <pre>001 002 Entrance to Machine A. Then, 003 push the Manual Mode switch 004 and use Manual Mode unit 005 full automatic becomes possible.</pre>         The first line of text has been removed, leaving a blank line at the top.         </p>	<p>To delete the selected data, perform steps (1) and (2) only.</p>
<p><b>(3) Move the cursor to the text's destination. Then, select the [Edit] menu - [Paste] command, or click on the  icon.</b> The deleted characters will be pasted at the specified position.</p>  <p>The screenshot shows the text editor window with the text:         <pre>001 002 Entrance to Machine A. Then, 003 Remove the material A from thepush the Manual Mode switch 004 and use Manual Mode unit 005 full automatic becomes possible.</pre>         The first line is blank, and the text from the first step has been pasted back into the second line.         </p>	

\*1 When the [Copy] or [Cut] command is executed, the copied or deleted data are temporarily stored in the clipboard. When you execute the [Paste] command, the data stored in the clipboard can be pasted on a desired position.



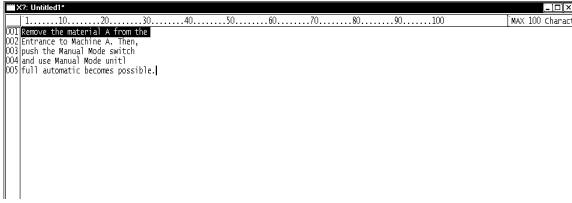

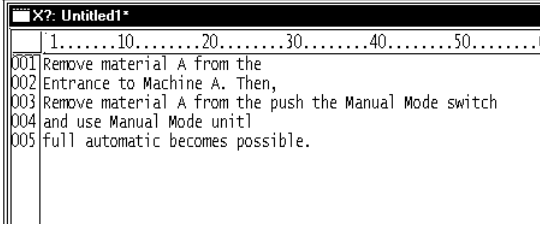
■ Copying Text

Copy selected text data, and store the text data into the clipboard.

PROCEDURE	REMARKS
<p><b>(1) Select the text data to be copied.</b></p> 	<p>To select several characters, drag the mouse within the desired text range.</p> <p>To select all the text, select the [Edit] menu - [Select All] command.</p>
<p><b>(2) Select the [Edit] menu - [Copy] command, or click on the  icon.</b></p> <p>The selected characters will be copied into the clipboard.</p>	
<p><b>(3) Move the cursor to the copy's destination. Then, select the [Edit] menu - [Paste] command, or click on the  icon.</b></p> <p>The text data stored in the clipboard will be pasted at the specified position.</p> 	

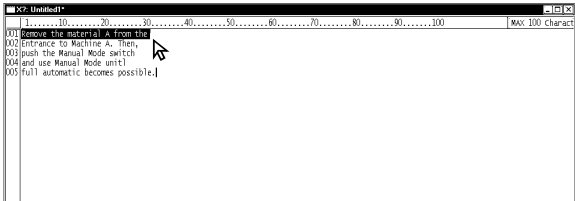
**■ Deleting Text**

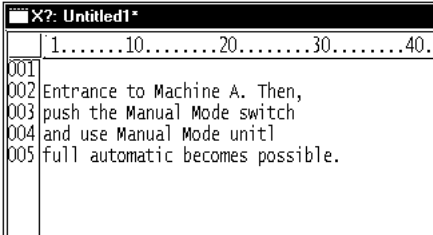

Delete text data.

PROCEDURE	REMARKS
<p><b>(1) Select the text data to be deleted.</b></p> 	<p>To select several characters, drag the mouse within the desired text range.</p> <p>To select all the text, select the [Edit] menu - [Select All] command.</p>
<p><b>(2) Select the [Edit] menu - [Delete] command, or click on the  icon.</b> The selected characters will be deleted.</p> 	<p>You can execute the same operation by pressing the <input type="button" value="Delete"/> key of your personal computer's keyboard, instead of clicking on the  icon.</p> <p>To cancel the [Delete] command, click on the  icon.</p>



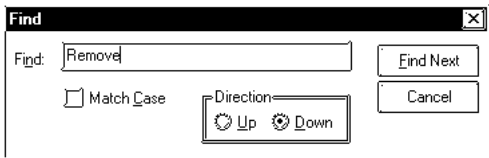
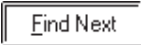

■ **Searching for Text**

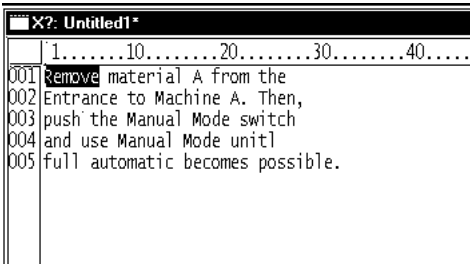
Search for a desired character string.

PROCEDURE	REMARKS
<p>(1) Select the [Search] menu - [Find] command.</p> <p>(2) Enter the character string to be searched for and select the search direction, i.e. upward or downward. The cursor position indicates the search start position.</p>  <p>(3) Click on the  button to execute the search operation.</p> <p>The search operation will be started in the specified direction. To continue the search operation for the same character string, click on the  button until there is no matching string. When there is no matching string, the search operation will stop.</p> 	<p>To differentiate between the uppercase and lowercase characters during the search operation, use the “Match Case” function.</p>

**■ Utilizing Other Text Files**

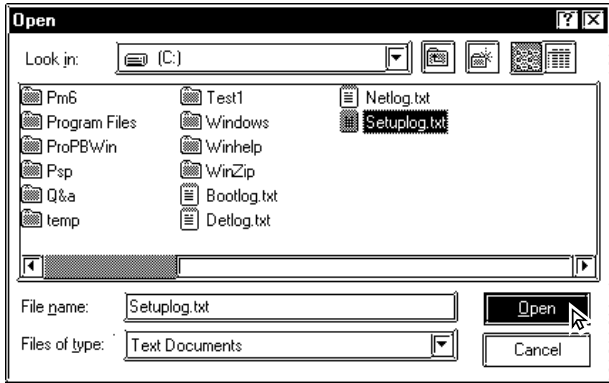
Other text files formatted for Windows can be used for the GP series. The procedure for using the Windows NotePad data for the GP series is as follows:

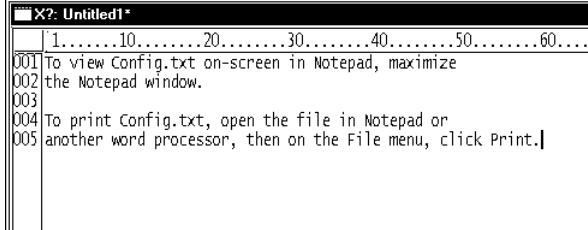
PROCEDURE	REMARKS								
<p>(1) Start the NotePad, and open the file to be used.</p> 									
<p>(2) Select the character strings to be used for the GP series.</p> <pre> ----- How to Use This Document ----- To view Config.txt on screen in Notepad, maximize the Notepad window. To print Config.txt, open it in Notepad or another word processor, then use the Print command on the File menu.  In syntax lines, lowercase text signifies replaceable parameters and uppercase text must be typed as it appears.                     </pre>									
<p>(3) Using the Notepad's [Edit] menu - [Copy] command, load the selected strings from NotePad into the clipboard.</p>									
<p>(4) Move the cursor to the position where you wish to paste the selected text. Then, select the [Edit] menu - [Paste] command, or click on the  icon. The strings stored in the clipboard will be pasted to the specified position.</p> 	<p>To differentiate between the uppercase and lowercase characters during the search operation, use the "Match Case" function.</p> <table border="1"> <thead> <tr> <th>Maximum number of characters</th> <th>GP Type</th> </tr> </thead> <tbody> <tr> <td>40</td> <td>GP-H70, GP-270, GP-370, GP-377, GP-37W2, GP-377R, GP-2301H, GP-2300, GP-2301</td> </tr> <tr> <td>80</td> <td>GP-470, GP-570, GP-571, GP-870, GP-477R, GP-577R, GP-2401H, GP-2400, GP-2401, GP-2500, GP-2501</td> </tr> <tr> <td>100</td> <td>GP-675, GP-2600, GP-2601</td> </tr> </tbody> </table>	Maximum number of characters	GP Type	40	GP-H70, GP-270, GP-370, GP-377, GP-37W2, GP-377R, GP-2301H, GP-2300, GP-2301	80	GP-470, GP-570, GP-571, GP-870, GP-477R, GP-577R, GP-2401H, GP-2400, GP-2401, GP-2500, GP-2501	100	GP-675, GP-2600, GP-2601
Maximum number of characters	GP Type								
40	GP-H70, GP-270, GP-370, GP-377, GP-37W2, GP-377R, GP-2301H, GP-2300, GP-2301								
80	GP-470, GP-570, GP-571, GP-870, GP-477R, GP-577R, GP-2401H, GP-2400, GP-2401, GP-2500, GP-2501								
100	GP-675, GP-2600, GP-2601								

### ■ Setting the Maximum Number of Characters per Line

You can set the maximum number of characters that can be entered per line. To set the maximum number of characters per line, move the ruler. The specified number of characters is displayed at the right of the ruler.

When the input data exceeds the specified number of characters per line, the characters will be automatically entered in the next line.

If you reduce the specified maximum number of characters after data input, the characters exceeding the current limit will be automatically entered in the next line.

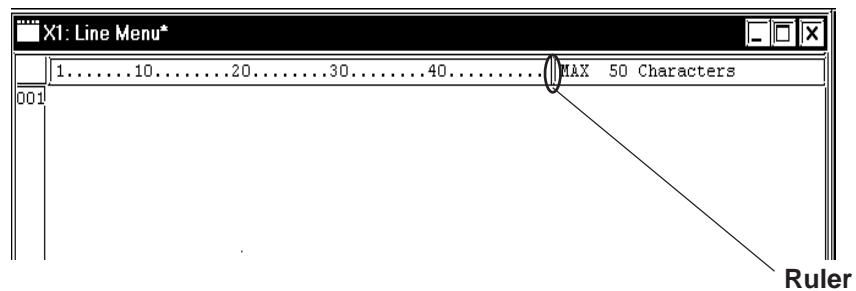

**3.4.2 Editing MultiLanguage Text Screens**

The following explanation describes how to edit Multilanguage text screens. For detailed Multilanguage feature information, **Reference** 4.6 *String Table Editor*

**Note:** • This feature is available only on GP2000 Series units.

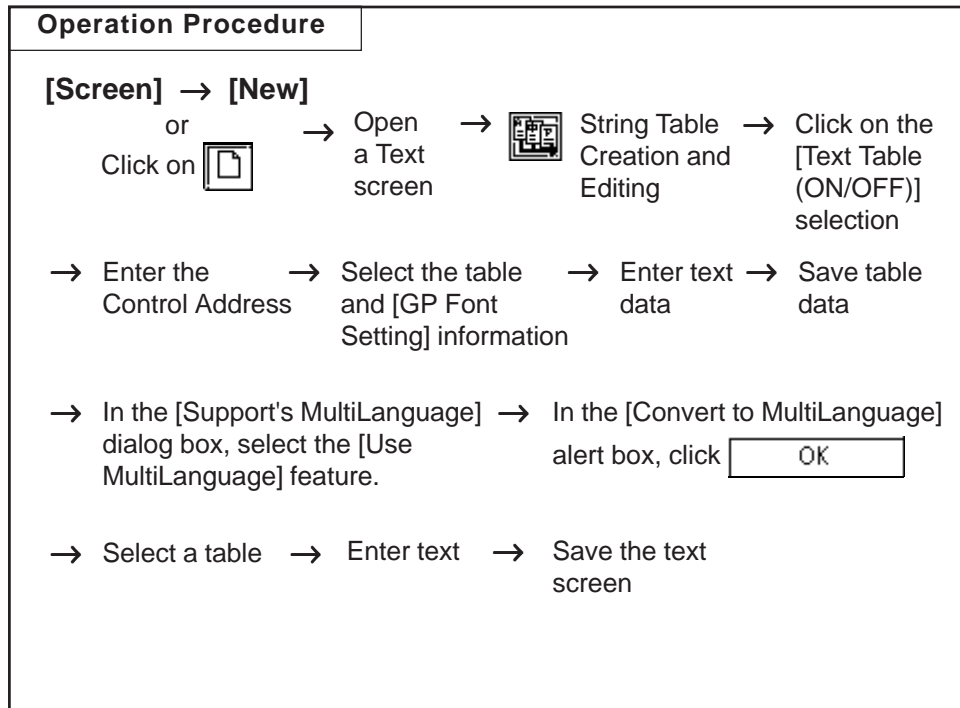

■ Overview Description of MultiLanguage Text Screens

A maximum of 16 text screens can be registered to a single Text screen. With text data saved on separately registered tables, a screen's language or contents can be easily changed during GP operation.

Ex.) Screen design when changing screen languages

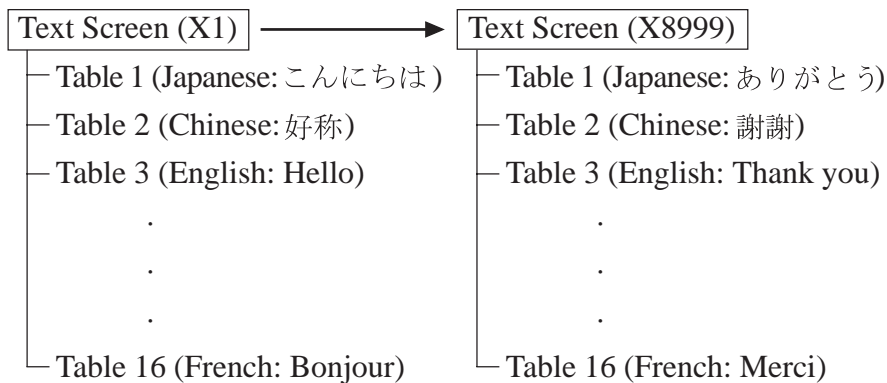

**Note:** • For an overview of the MultiLanguage feature, **Reference** 4.6.1 *Overview - MultiLanguage Display Feature*

## ■ MultiLanguage Text Screen

Click here to call up  
the Text Table Editor

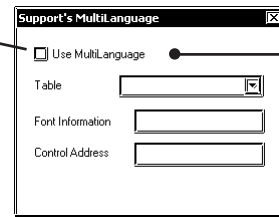
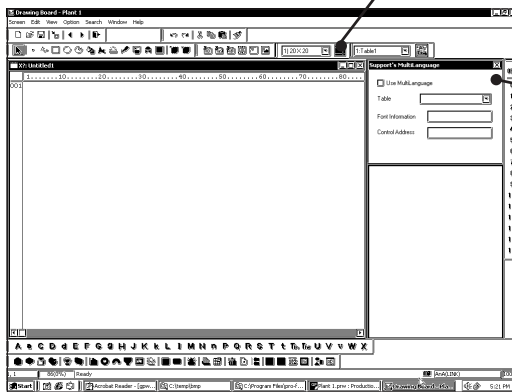

When the [Use MultiLanguage] check box is checked, text screens compatible with the MultiLanguage display feature can be edited. (Only for GP2000 Series units) For details, **Reference** 4.6.2 *Table Editor Character Strings*

### ◆ Use MultiLanguage

When this is selected/enabled, the text entry mode changes to multiple language entry mode.

### ◆ Table

Select the desired table name.

Select from a list of tables previously registered via the Text Table Editor. If a table's name is "-----" that table has not yet been registered and cannot be selected. Table names can be changed via the Text Table Editor.

**Reference** 4.6.2 *Table Editor Character Strings* ■ *Table Name*

### ◆ Font Information

Displays the font set for the selected table. Fonts can be selected via the Text Table Editor.

**Reference** 4.6.2 *Table Editor Character Strings* ■ *GP Font Settings*

### ◆ Control Address



Displays the Control Address set for the selected table. This address is used to change the text screens. Control Addresses are entered and edited via the Text Table Editor.

**Reference** 4.6.2 *Table Editor Character Strings* ■ *Entering Control Address Settings*

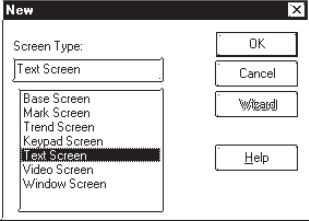

- When using the text screen's MultiLanguage feature, if the [Text Table (ON/OFF)] feature is selected, tables created will use the same table, control (word) address and font names as standard tables. When editing this data, use the Text Table Editor.

■ Editing Multilanguage Text Screens

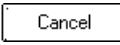
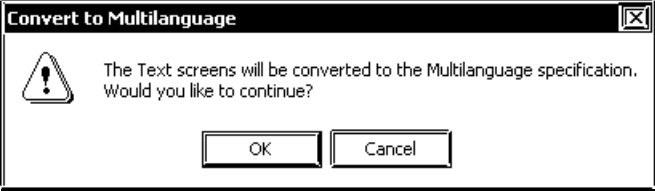
PROCEDURE	REMARKS
<p>(1) Click on [Screen] and then [New], or click on the  icon and select Text Screen.</p> <p>(2) A Text Screen will open.</p>  <p>(3) Click on the  (Text Table) to call up the Text Table Editor.</p> <p>(4) Click on the [Text Table (ON/OFF)] feature to select it.</p> <p>(5) Set the Control Address, Table and Font information, enter the desired text string and then save the table.</p> <p>(6) Return to the Text Screen and in the [Support's MultiLanguage] dialog box, select [Use MultiLanguage]. When the warning dialog box appears, click  to close the box. Click on  to cancel the Multilanguage feature.</p>  <p>(7) Select the desired table from the [Table] pull-down menu. All the table names displayed here are tables previously registered in the Text Table Editor. The table's font and control address information is also displayed.</p>	<p>Be sure to click on the [Text Table ON/OFF] selection.</p> <p>For detailed Text table editor setup instructions, <a href="#">▼ Reference ▲</a> <b>4.6.2 Table Editor Character Strings ■ Character String Registration</b></p> <p>To create a Text table, enter and save at least one text string in the table. This process is necessary to specify a font for the table.</p> <p>Be sure to click on the [Use MultiLanguage] setting.</p> <p>All table names displayed as "-----" cannot be selected.</p> <p>Table names cannot be changed via the Text Screen.</p>

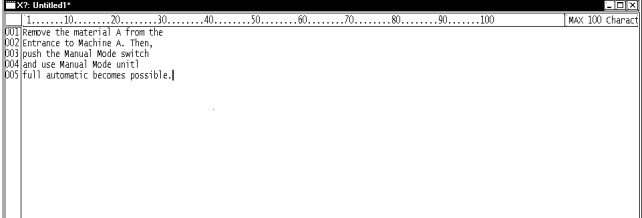
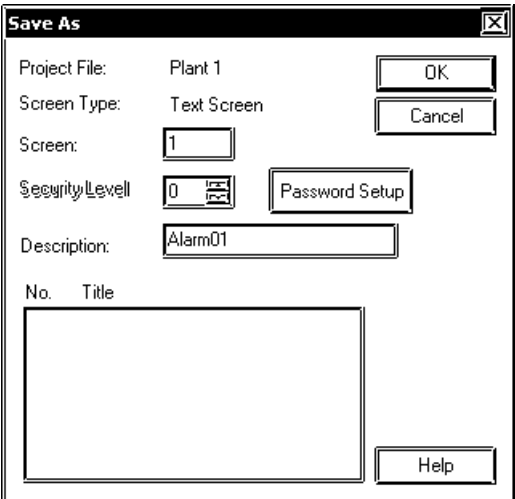
PROCEDURE	REMARKS								
<p><b>(8) Use your keyboard to enter text into the text display area.</b></p> <p>Be sure to press the [Enter] key  at the end of each line.</p> 	<table border="1"> <thead> <tr> <th>Maximum number of characters</th> <th>GP Type</th> </tr> </thead> <tbody> <tr> <td>40</td> <td>GP-H70, GP-270, GP-370, GP-377, GP-37W2, GP-377R, GP-2301H, GP-2300, GP-2301</td> </tr> <tr> <td>80</td> <td>GP-470, GP-570, GP-571, GP-870, GP-477R, GP-577R, GP-2401H, GP-2400, GP-2401, GP-2500, GP-2501</td> </tr> <tr> <td>100</td> <td>GP-675, GP-2600, GP-2601</td> </tr> </tbody> </table>	Maximum number of characters	GP Type	40	GP-H70, GP-270, GP-370, GP-377, GP-37W2, GP-377R, GP-2301H, GP-2300, GP-2301	80	GP-470, GP-570, GP-571, GP-870, GP-477R, GP-577R, GP-2401H, GP-2400, GP-2401, GP-2500, GP-2501	100	GP-675, GP-2600, GP-2601
Maximum number of characters	GP Type								
40	GP-H70, GP-270, GP-370, GP-377, GP-37W2, GP-377R, GP-2301H, GP-2300, GP-2301								
80	GP-470, GP-570, GP-571, GP-870, GP-477R, GP-577R, GP-2401H, GP-2400, GP-2401, GP-2500, GP-2501								
100	GP-675, GP-2600, GP-2601								
<p><b>(9) After all text is entered, input a name and save the table data.</b></p> 	<p>You can enter up to 512 lines on one screen. Line number 513 or subsequent lines cannot be displayed.</p>								

**■ Usage Restrictions**

When registering multiple tables to a single text screen (Ex. X1) and the Support's MultiLanguage dialog box's [Use MultiLanguage] check box is not selected, only [Table 1]'s text will appear in the Text Display Area, and all other related tables cannot be displayed or edited.

If that text screen (X1) is then saved and closed, only the text data for Table 1 is saved. When the text screen (X1) is reopened, all the previously registered tables are not displayed (except for Table 1).

### 3.4.3 Text Screen Import/Export

This section explains the export of text screen data as a .txt or .csv file, as well as the import of .txt or .csv file data.



- Importing/Exporting text screens compatible with the MultiLanguage display feature is available only on the GP2000 Series units.

#### ■ Selecting the Format of an External File and the Import/Export Operation

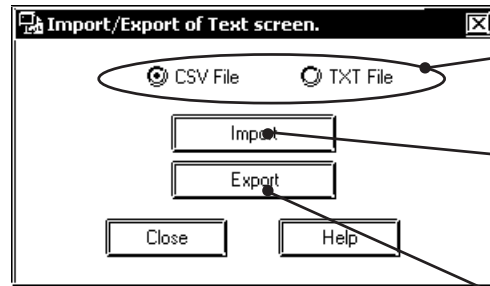

Selects the format of the data to be imported (to a text screen) or exported (from a text screen).

Designates the data will be imported to a text screen from an external file.

Designates the data will be exported from a text screen to an external file.



- The data is imported/exported immediately after the setting above if all text screens in the project file do not use the MultiLanguage display feature. If any of the text screens are compatible with the MultiLanguage display feature, the data is imported/exported after the table specification step shown below.

#### ■ Designating the Conversion Origin (Importing to a Text Screen)

If any of the registered text screens have the [Use MultiLanguage] check box checked, set whether to specify a table as the destination to import the file.

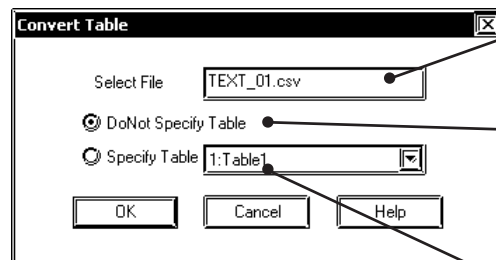

Displays the name of the file to be imported to the Text Screen.

Designates that the data is imported to a text screen which is not compatible with the MultiLanguage display feature.

Designates that the data was imported to a text screen which is compatible with the MultiLanguage display feature. Also selects the registered table name of the imported data.



■ **Conversion Table Designation (Exporting from a Text Screen)**

If any of the registered text screens have the [Use MultiLanguage] check box checked, set whether to specify the table of the text screen to be exported.

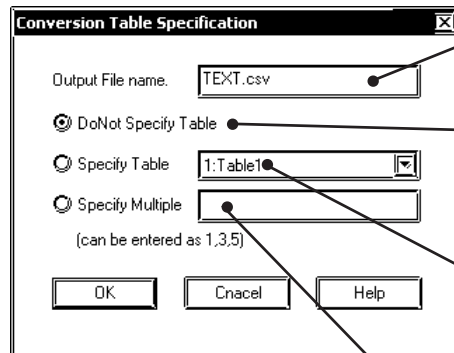

Displays the file name of the external file.

Designates that the data from a text screen for which the [Use MultiLanguage] check box is not checked is exported to an external file.

Designates that the data from a text screen for which the [Use MultiLanguage] check box is checked is exported to an external file. It is necessary to select the name of the table to be exported.

Designates that the specified multiple tables from a text screen for which the [Use MultiLanguage] check box is checked are exported all together. Table Nos. should be separated with "," (comma).

■ **Text Screen's External File Format**

◆ **CSV file Format**

Ex.) A text screen for which [Use MultiLanguage] is not checked (disabled).  
(Filename: TEXT.csv)

1	2	Screen Number
Setting	Display	Screen Title
Start	Caution	Text
Finish	Warning	

**When Exporting Data:**

- If there are several text screens for which the [Use MultiLanguage] check boxes are not checked (disabled), all the text screen data is exported as one .csv file (TEXT.csv in the example on the previous page).
- If the number of text screens to be exported exceeds 255, the CSV file editing tool (software) may not be able to display all the data as a single file because the number of columns is insufficient. When the following dialog box appears, click [Yes] to divide and export the data into multiple files. Click [No] to export the data in a single file.

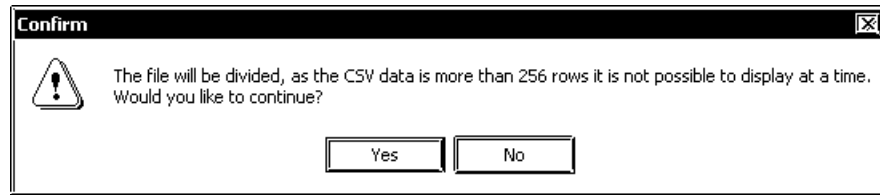

- If the data is divided and exported into multiple files, the files will have sequential numbers starting from (1) after their names, i.e. "Text.csv" will be converted to "Text(1).csv", "Text(2).csv" and so on.

Ex.) A text screen for which [Use MultiLanguage] is checked (enabled).  
 (Exported file has been saved as TEST.csv)

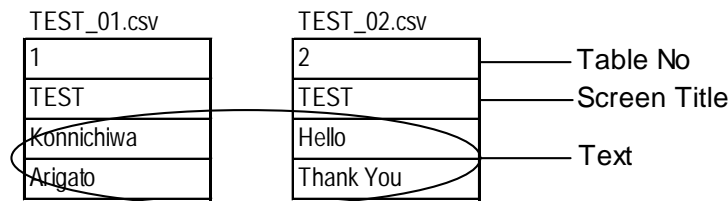

**When Exporting Data:**

- If the data from a text screen for which the [Use MultiLanguage] check box is checked ([Specify Multiple] is checked and Table Nos. are specified) is exported, each table is exported as a .csv file and the file name is created based on the [Screen Title]\_[Table No] format. (TEST\_01.csv in the example above).



• For information about MultiLanguage display compatible text screens, **Reference** 3.4.2 *Editing MultiLanguage Text Screens*.

◆ **Text File Format**

Ex.) A text screen for which [Use MultiLanguage] is not checked (disabled).  
(File name: TEXT.txt)

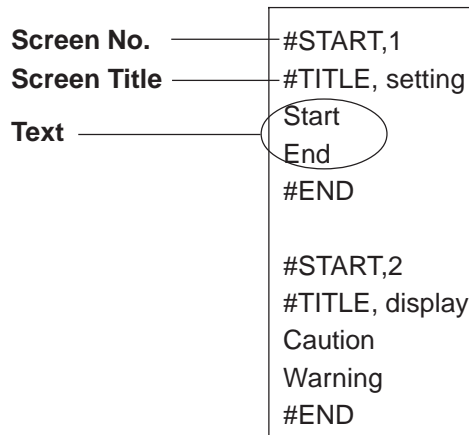

**When Exporting Data:**

- If there are several text screens for which the [Use MultiLanguage] check boxes are not checked (disabled), all the text screen data is exported as one .csv file (TEXT.csv in the example above).

Ex.) A text screen for which [Use MultiLanguage] is checked (enabled).  
(Filename: TEST.txt)

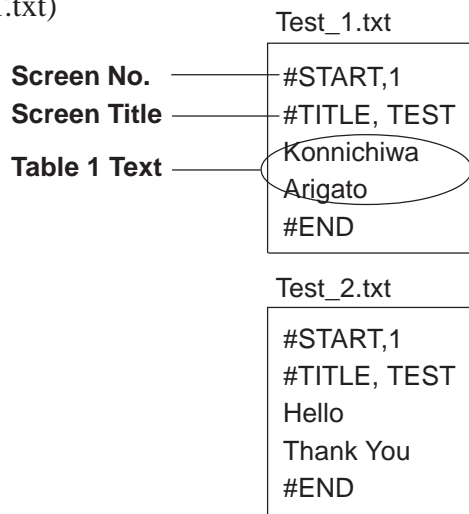





**When Exporting Data:**

- If the data from a text screen for which the [Use MultiLanguage] check box is checked ([Specify Multiple] is checked and Table Nos. are specified) is exported, each table is exported as a .txt file and the file name is created based on the [Screen Title]\_[Table No] format. (Above example is TEST\_1.txt).



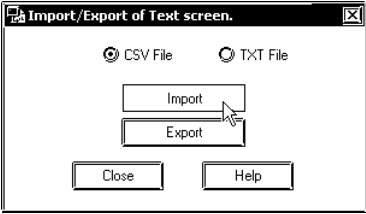
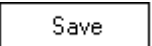
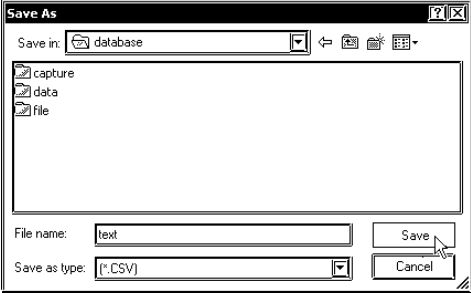

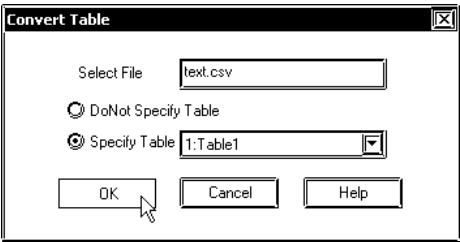
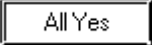

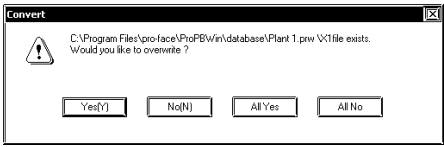
• For information about MultiLanguage display compatible text screens,  
**Reference** 3.4.2 Editing MultiLanguage Text Screens.

■ Importing External Files (\*.csv, \*.txt) to Text Screens

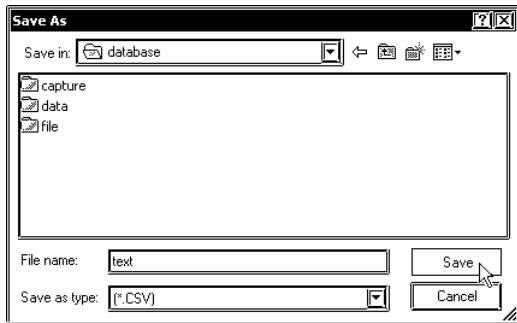
PROCEDURE	REMARKS								
<p>(1) Select the Project Manager [Utility] menu's [Import/Export of Text screen] command.</p> <p>(2) Select the type of file to import (.csv or .txt) and click [Import].</p>  <p>(3) Use the [Open File] command to select the desired external file, and click .</p>  <p>(4) When a file is imported to a text screen for which [Use MultiLanguage] is not checked (disabled), check [Do Not Specify Table] in the [Convert Table] dialog box and click .</p> <p>When a file is imported to a text screen for which [Use MultiLanguage] is checked (enabled), check [Specify Table] in the [Convert Table] dialog box.</p>  <p>(5) The file(s) will not be imported. When import is completed, [End of Conversion] will appear. Click [Close] to quit the utility.</p>	<table border="1"> <thead> <tr> <th>Maximum number of characters</th> <th>GP Type</th> </tr> </thead> <tbody> <tr> <td>40</td> <td>GP-H70, GP-270, GP-370, GP-377, GP-37W2, GP-377R, GP-2301H, GP-2300, GP-2301</td> </tr> <tr> <td>80</td> <td>GP-470, GP-570, GP-571, GP-870, GP-477R, GP-577R, GP-2401H, GP-2400, GP-2401, GP-2500, GP-2501</td> </tr> <tr> <td>100</td> <td>GP-675, GP-2600, GP-2601</td> </tr> </tbody> </table> <p>You can enter up to 512 lines on one screen. Line number 513 or subsequent lines cannot be displayed.</p> <p>If all text screens in the project file do not use the MultiLanguage display feature, the file is imported immediately after step 3. If there are one or more text screens compatible with the MultiLanguage display feature in the project file, the file is imported after the table specification in step 4.</p> <p>If text screens with the same screen number exist, a message asking if it is OK to overwrite will appear. To overwrite the existing file with the imported file, click [Yes]. To stop the Import process, click [No]. If multiple screens exist, a confirmation screen with the words  and  will appear.</p> 	Maximum number of characters	GP Type	40	GP-H70, GP-270, GP-370, GP-377, GP-37W2, GP-377R, GP-2301H, GP-2300, GP-2301	80	GP-470, GP-570, GP-571, GP-870, GP-477R, GP-577R, GP-2401H, GP-2400, GP-2401, GP-2500, GP-2501	100	GP-675, GP-2600, GP-2601
Maximum number of characters	GP Type								
40	GP-H70, GP-270, GP-370, GP-377, GP-37W2, GP-377R, GP-2301H, GP-2300, GP-2301								
80	GP-470, GP-570, GP-571, GP-870, GP-477R, GP-577R, GP-2401H, GP-2400, GP-2401, GP-2500, GP-2501								
100	GP-675, GP-2600, GP-2601								

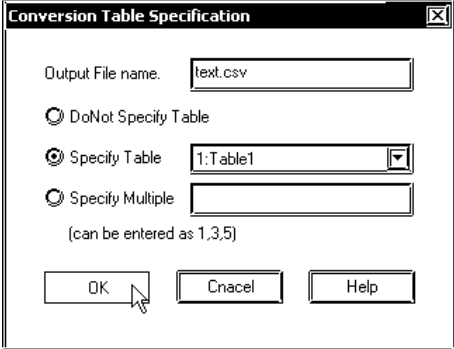
■ Exporting Text Screens to External Files (\*.csv, \*.txt)

PROCEDURE	REMARKS
<p>(1) Select the Project Manager [Utility] menu's [Import/Export of Text screen] command.</p> <p>(2) Select the type of file to import (.csv or .txt) and click [Export].</p> <p>(3) Use the [Open File] command to select the desired external file, or enter the name of the file and click .</p>  <p>(4) When a text screen for which [Use MultiLanguage] is not checked (disabled) is exported, confirm the name of the destination file in the [Conversion Table Specification] dialog box, check [DoNot Specify Table] and click .</p> <p>When a text screen for which [Use MultiLanguage] is checked (enabled) is exported, check [Specify Table] in the [Conversion Table Specification] dialog box. To export multiple tables, enter Table Nos. and click .</p>  <p>(5) Export will be performed and the file will be created at the designated location.</p>	<p>If all text screens in the project file do not use the MultiLanguage display feature, the data is exported immediately after step 3. If there are one or more text screens compatible with the MultiLanguage display feature in the project file, the data is exported after the table specification in step 4.</p> <p>If text screens with the same screen number exist, a message asking if it is OK to overwrite will appear. To overwrite the existing file with the imported file, click [Yes]. To stop the Import process, click [No].</p> 

## 3.5 Creating an Image: the Image Screen

When converting an image data (bitmap: BMP file and JPEG: .JPG file) into an Image screen for the GP series, the image data can be displayed on the GP series panel.

You can load an Image screen onto a Base screen, Trend Graph screen, Keyboard screen or Window screen by selecting the [Draw] menu - [Load Screen] command.

### Reference 2.2.10 Load Screens

You can animate the Image screen by using the L-tag.

To convert image data into Image screen data for the GP series, use the [Utility] menu - [Convert Image] command.



- The Image Screen cannot be opened with the Screen Editor.
- You can also perform the conversion in the screen editor by selecting the [Draw] menu - [Convert/Image] command.

### Reference 2.2.12 Convert (Import) Image

- Image screens cannot be edited. To edit the image data, you must use the original file, and then convert this file into Image screen data. The Image screens can be checked on the screen list.

### Reference 4.1.1 Listing/Copying/Deleting Screen

- This command can convert image data of up to 800 x 600 dots. Note that any portion that does not fit into the GP screen will be cut off before conversion.

### 3.5.1 Image Conversion

Convert image data (bitmap: BMP file and JPEG: JPG file) created with other editor software or read with an image scanner into an Image (I) screen for the GP series.

Number of colors		1 bit		4 bits		8 bits		16-bit color	24-bit color	32-bit color
		2 colors (black & white)	16 colors	16-level gray scale	256 color	256-level gray scale				
Windows BMP/DIB	*.BMP	○	○	○	○	○	○	○	○	○
Windows BMP/DIB(RLE4)		-	○	○	-	-	-	-	-	-
Windows BMP/DIB (RLE8)		-	-	-	○	○	-	-	-	-
JPEG	*.JPG	-	-	-	-	○	-	○	-	-

With a color Image screen, the data volume becomes large, but the GP series' display speed is increased. With a monochrome Image screen, the GP series' display speed is slightly lowered, but the data volume can be reduced. Select a color or monochrome Image screen according to your purpose.

If the data volume is too large to be displayed on one screen, the converted data will be divided into several screens (up to nine screens).



- Make sure that the original image data's horizontal (X), and vertical (Y) dimensions are multiples of "4" for color data, or multiples of "8" for monochrome data. Otherwise the fractional (remainder) data will be cut from the right side and from the bottom of the image after conversion.

<With Color Data>

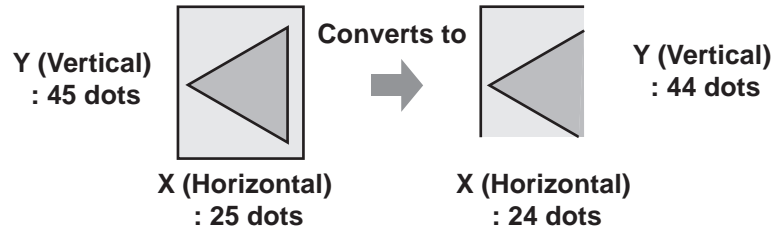

- If the length of the original image data is less than "4" for color data, or less than "8" for monochrome data, the image data cannot be converted.

### ■ Converting/Placing an Image: [Source]

Specify the image file to be converted. The information on the specified image file will be displayed.

Enter the name of the image file to be converted, or select the image file from the file list by clicking on the [Browse] button

Select the image file to be converted

Displays information on data colors (e.g. 16 colors, 256 colors)

Displays the size of the image file

Displays the dimensions (horizontal x vertical) of the image data

Displays the image of the image file to be converted. However, this image is different from the image that will be displayed on the GP series

Register the above settings to execute the image conversion. If you save the converted image data, the image screen of the screen number specified in [Screen Setting] will be created

## ■ Converting/Placing an Image: [Effects]

Specify the brightness, resolution, blinking, compression, and mirror functions for the converted image data.

Used to set the brightness and display quality automatically

When 256-colors are selected, "Blink" cannot be selected

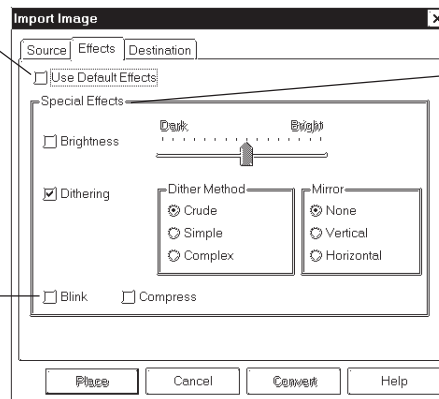

Used to manually set the individual options of the brightness and display quality

### ◆ Use Default Effects

When you specify Use Default Effects, the original data will be automatically converted into the image data with the optimum brightness and display quality.

### ◆ Brightness

Used to convert bitmap data according to the brightness level. The reference value can be changed between levels "0" and "15". A larger value indicates a brighter image, and a smaller value indicates a darker image.

### ◆ Dithering

Used to set the converted data's display quality.

### ◆ Blink

Used to make the converted data blink.



***Blink cannot be used when the screen is displayed at 256 colors.***

### ◆ Compress

Used to compress the original bitmap data during conversion.

### ◆ Mirror

Used to replace the original bitmap data symmetrically relative to the X-axis or Y-axis during conversion.



### ■ Converting/Placing an Image: [Destination]

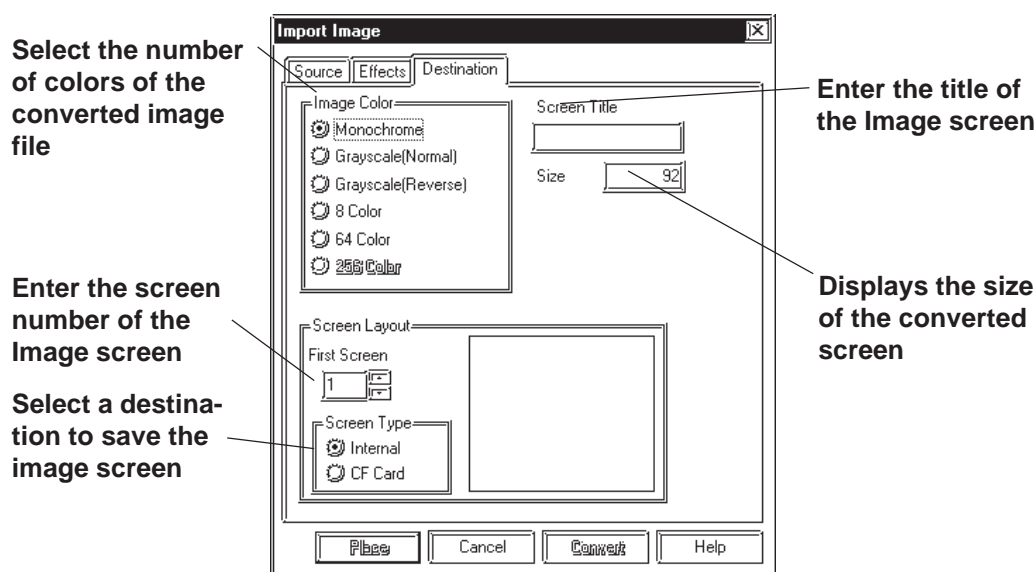

#### ◆ Image Color

Select the type of bitmap file conversion: Monochrome, Grayscale(Normal), Grayscale(Reverse), 8 Color, 64 Color or 256 Color. The screen size and the number of screen divisions vary with the type selected.

Select "MONOCHROME 8 HUES" on the [GP Setup] dialog box before selecting the "MONOCHROME 8 HUES" option on the monochrome LCD GP2000 Series units (GP-2301HL, GP-2300L, GP-2301L, GP-2500L or GP-2501L).



- Depending on the color used, selecting MONOCHROME 8 HUES may cause the GP unit's screen to flicker. Confirm the color before using this feature.

Select "256 colors without blinking" mode on the [GP Setup] dialog box before selecting the "256 Color" option on the GP2000 Series units(excluding the GP-2301HL, GP-2301HS, GP-2300L, GP-2300S, GP-2301L, GP-2301S, GP-2500L, GP-2500S, GP-2501L and GP-2501S Series units).

#### ▼ Reference 6.1 ■ Tab Setting Items ◆ Initial Screen Settings

#### ◆ First Screen

Enter the screen number of the Image screen. If no screen number is specified, an Image screen of the currently displayed screen number will be created.

#### ◆ Screen Type

Select whether the image screen is to be saved on the GP's internal memory or the CF card.

#### ▼ Reference Tag Reference Manual, 4.7 Using the CF Card



- You can select the CF card if your GP is a GP77R series or a GP2000 series. Using the GP77R series requires the optional Multi Unit.
- When the CF card is specified, the drawing speed on a screen where the image screen is placed become slower than GP memory is specified.

◆ **Screen Title**

Enter the title of the Image screen. Even if the converted data are divided into several screens, only one title can be specified for one original file.

◆ **Size**

Displays the size of the converted screen.

■ **Converting an Image**

Convert an image file into Image screen data.

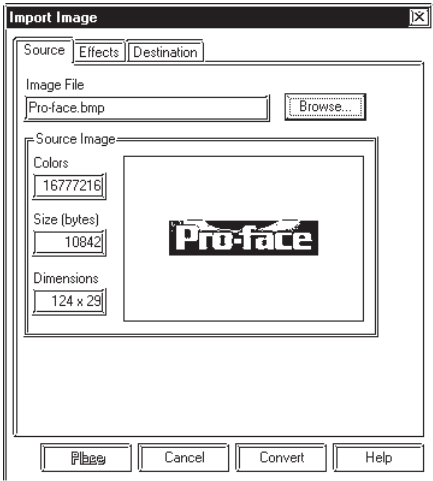
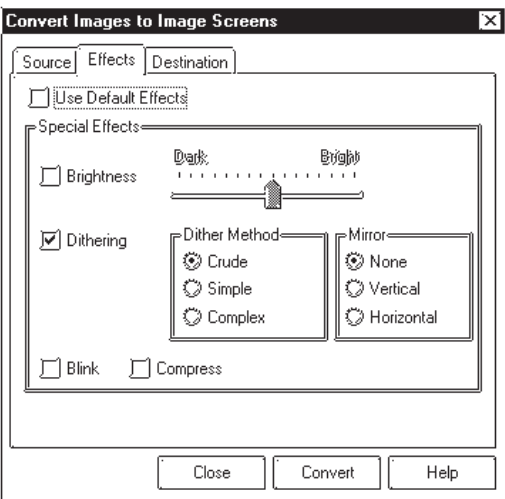
PROCEDURE	REMARKS
<p>(1) Select the [Utility] menu - [Convert Image] command of the Project Manager.</p> <p>(2) Click on the  button, and select an image file to be converted. The color type, data volume, screen size and image data of the bitmap file will be displayed.</p>  <p>(3) Specify the conversion parameters. If the data volume is too large to be displayed in one screen, the image data will be divided into several Image screens.</p> 	<p>If the original data are monochrome, these conversion parameters cannot be specified.</p> <p>The “Blink” feature can be specified for the GP-571T, GP-675, GP-377S, GP-377R, GP-577R and GP2000 series units only.</p>

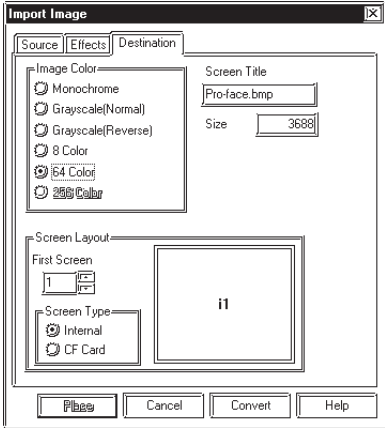
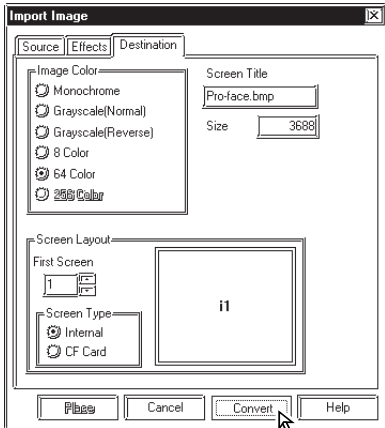
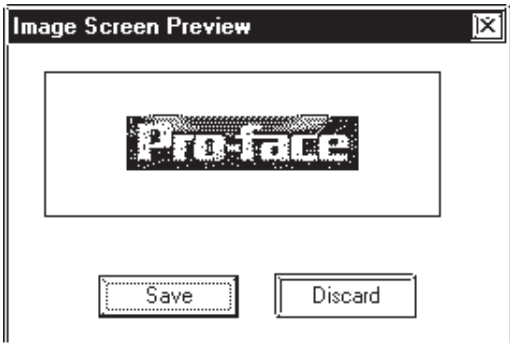
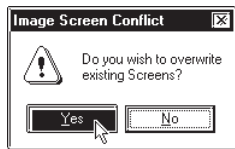
PROCEDURE	REMARKS
<p><b>(4) Enter the screen number and title of a new Image, and designate Screen Type.</b> If you do not set a title, the title of the original Image file will be specified.</p>	<p>The Grayscale(Normal) and Grayscale (Reverse) is valid only for Monochrome LCD GP2000 Series units (GP-2301HL, GP-2300L, GP-2301L, GP-2500L and GP-2501L only). Be sure to set the [GP Setup] to [Monochrome]. The “64 Color” mode can be specified for the GP-571T, GP-675, GP-377S, GP-377R, GP-577R and GP2000 Series units only. The “256 Color” mode can be specified for the GP2000 Series units (except GP-2301HL, GP-2300L, GP-2500L and GP-2501L) only.</p>
	<p><b>▼ Reference</b> 6.1 Initial Screen Settings</p>
<p><b>(5) Click on the <input type="button" value="Convert"/> button to perform data conversion.</b> The image data conversion starts. Then, the converted image will be displayed.</p>	<p>The number of colors specified for [Screen Color] must be equal to the number of display colors supported by your GP series.</p> <ul style="list-style-type: none"> <li>· If the number of colors is different, the display speed will be lowered.</li> <li>· Any colors that are not supported with your GP series cannot be displayed.</li> </ul> <p>Only when your GP type is the GR-77R or GP2000 series, the CF card can be specified in the [Screen Type] section.</p>
	<p><b>▼ Reference</b> Tag Reference Manual, 4.7 Using the CF Card</p>
<p><b>(6) If the displayed image is correct, click on the <input type="button" value="Save"/> button.</b> An Image screen is created.</p>	<p>If the same screen number already exists, the system asks if you want to replace the existing screen with the one you are attempting to save. If so, select <input type="button" value="Yes"/>; otherwise, select <input type="button" value="No"/>.</p>
	
	<p>To cancel conversion, click on the <input type="button" value="Discard"/> button.</p>
	<p>When an image is converted by selecting the [Convert Image] command from the [Draw] menu on the Screen Editor, pressing the [Place] button allows the converted image screen to be placed.</p>

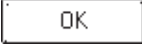
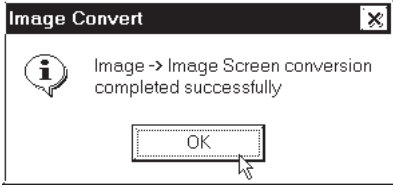
PROCEDURE	REMARKS
<p>(7) Click on the  button to quit the conversion mode.</p> 	<p><b>Reference</b> 2.2.12 <i>Convert (Import) Image</i></p> <p>Select the [Load Screen] command from the [Draw] menu to place the converted image.</p> <p><b>Reference</b> 2.2.10 <i>Load Screens</i></p>

### 3.5.2 Compressing/Decompressing an Image Screen

If the size of the Image screen is large, you can compress it to reduce the data size. The data is compressed to one-fifth the size of the source data. The compressed Image screen data can then be displayed directly to the GP series. With the compressed Image screen, however, the GP series' display speed will be slower.

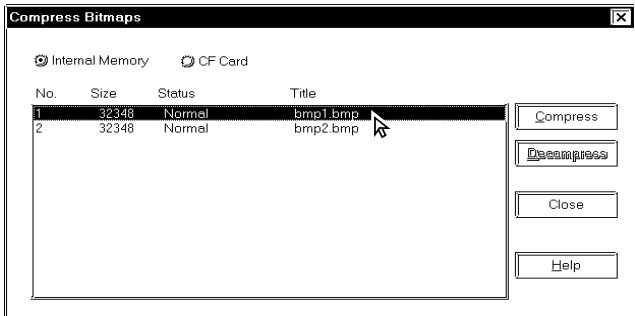
PROCEDURE	REMARKS
<p>(1) Select the [Utility] menu - [Compress Bitmap] command of the Project Manager.</p> <p>(2) Select the screen to be compressed or decompressed from the list.</p> 	<p>To compress an Image screen (bitmap data) of another project, select the project.</p> <p><b>Reference</b> 1.1.2 ■ <i>Selecting an Existing Project</i></p> <p>To select several screens, click on the screen numbers while pressing the <b>Shift</b> key.</p> <p>To select a specified screen, click on the screen number while pressing the <b>Ctrl</b> key.</p> <p>If the CF card is specified in step (2) when your GP type is the GP-77R series or GP2000 series, the image screen on the CF card can be compressed.</p> <p><b>Reference</b> <i>Tag Reference Manual, 4.7 Using the CF Card</i></p>
<p>The compression and decompression procedures are separately described as follows:</p>	

PROCEDURE	REMARKS
-----------	---------

**[Compression]**

(3) Click on the **Compress** button to execute data compression.

The process is finished when the word “Compressed” appears.

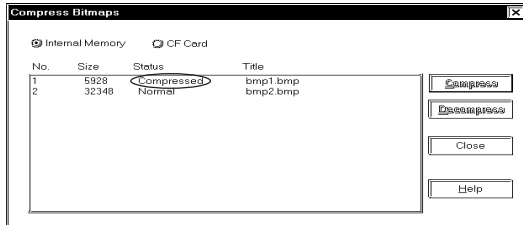

**[Decompression]**

(3) Click on the **Decompress** button to perform data decompression.

The process is finished when the word “Normal” appears.

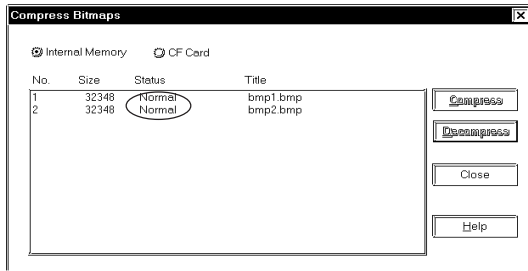

## 3.6 Video Data Display (V Screen)

Use a v-tag to call up the video window on the Video Screen (V file) onto the Base Screen (V file). This feature allows the video display to be displayed on the GP screen when necessary.



***This feature is supported only by the GP-2500T and GP-2600T. The optional VM Unit is required.***

The following two procedures can be used to display video windows: (1) Use a v-tag to display the video window on the specific Base Screen (B); or (2) display the video window as a global window for all screens.

In procedure (1), place a v-tag on the Base Screen (B). Select the [v-Tag] from the [Tag] menu to make the settings.

**▼ Reference ▲** *Tag Reference Manual, 2.28 v-tag (Extended Video Window Display)*

A v-tag can be set up only when "Extend(small v-tag)" is enabled. Select this mode using the following procedure before setting up a v-tag. Select [GP Setup] from the Project Manager and select [Extended Settings] and [Video Settings].

(2) For details of the global display:





**▼ Reference ▲** *3.6.2 Video Window Settings*

Select the [Video Setting] command from the [Tag] menu on the Video Screen (V) to set up a video window. If necessary, select [T-tag] from the [Tag] menu to set up a touch-switch for use in the video data display.

The environmental settings for video operation can be made by selecting [Video Setting] on [Extended Feature Settings] from the [GP Setup], or by selecting [Video Operation Settings] on the OFFLINE menu of the GP unit.



GP's screen drawing objects cannot be placed on video screens. You can check the contents of your video screens via the [Screen List] feature.

**▼ Reference ▲** *4.1.1 Listing/Copying/Deleting Screen*

Usage Pattern	
<ul style="list-style-type: none"> <li>To Create a Video Screen</li> </ul>	
<p>[Screen] → [New] or</p> <p>Click on  icon Select "Video Screen"</p>	<p>→ Click on <b>Tag</b> menu → Click on <b>Video Settings</b> or</p> <p>Click on  to set up a video screen Save the video screen</p>
<p>→ Click on <b>Tag</b> menu → Click on <b>T-Tag</b> or</p> <p>Click on  to set up a touch switch</p>	
<ul style="list-style-type: none"> <li>To Create a Base Screen</li> </ul>	
<p>Open the Base screen → Click on <b>Tag</b> menu → Click on <b>v-Tag</b> → Save the Base screen or</p> <p>Click on  to set up video settings.</p>	
<ul style="list-style-type: none"> <li>To use the <b>GP Setup</b> screen to enter video setting data.</li> </ul>	
<p>→ Click on <b>Screen/Setup</b> menu → Click on <b>GP-Setup</b> → <b>Extended Settings</b> → <b>Video Settings</b></p> <p>Click on  to set up video settings.</p>	

This feature is enabled by performing the above procedure.

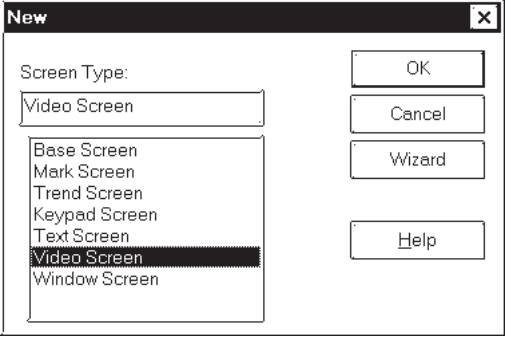
■ Entering Video Settings

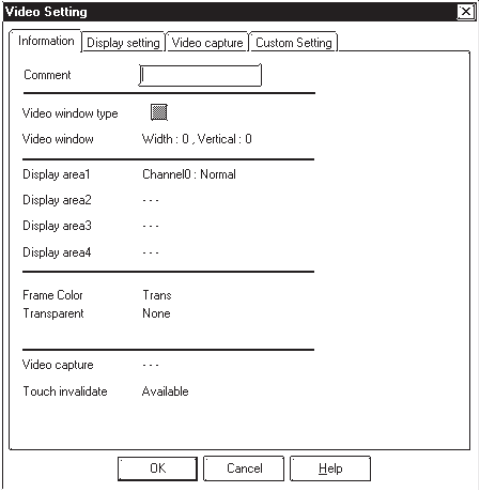
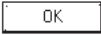
PROCEDURE	REMARKS
<p>(1) From the screen editor, select the [Screen] menu - [New] command, or click on the  icon.</p>  <p>(2) Select the “Video Screen”.</p> <p>The “Wizard” button is enabled only when video screen is selected. Clicking on the “Wizard” button calls up a dialog box that explains the video settings. Basic settings can be made in the Wizard dialog box. For detailed settings, adjust the settings on the [Video Setting] dialog box in step (3).</p> <p>(3) From the [Tag] menu, select [Video Setting], or click on the  icon.</p> <p>(4) Enter the desired video settings in the [Video Setting] tab screens.</p>  <p>(5) After all settings are entered, click on the  button.</p> <p>(6) Place the video data display area icon where you wish to have the video display on the GP screen. Re-size the icon to reflect the actual size of the display.</p>	<p><b>Reference</b> 1.1.3 Opening/Closing/Saving a Screen</p> <p><b>Reference</b> Tag Reference Manual, 2.28 v-tag (Extended Video Window Display)</p>



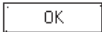
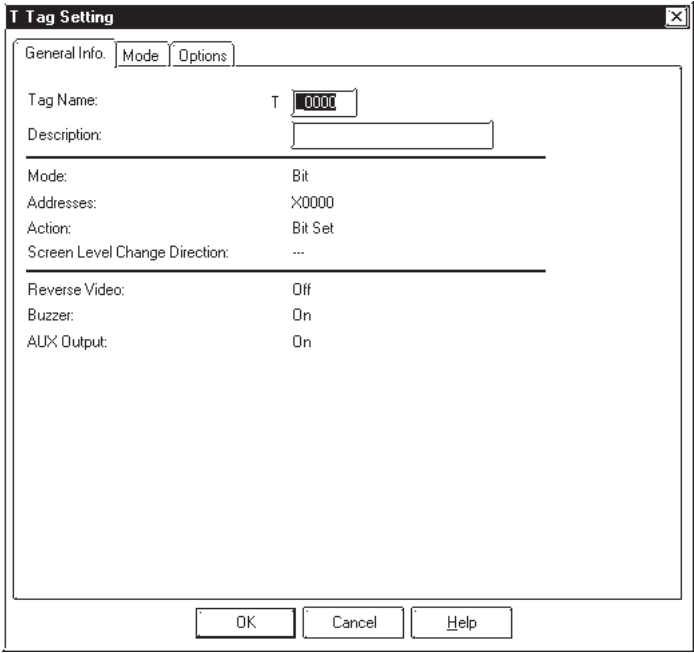
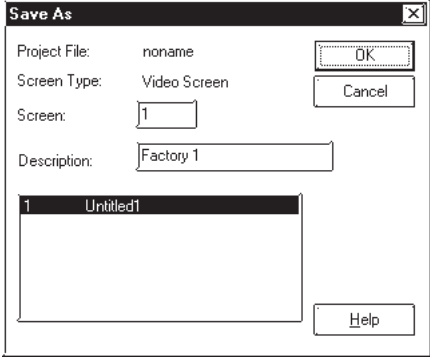

**■ Create a Touch Switch to Actvate the Video Data**

Place a touch switch with a T-tag on the video data display area. The touch switch can be used for various applications. For example, touching the video window changes the window size according to the T-tag settings.

PROCEDURE	REMARKS
<p>(1) Select the [Tag] menu - [T-tag] command, or click on the  icon.</p> <p>(2) After all settings are entered, click on the  button.</p>  <p>(3) Place the tag on the video data display area.</p> <p>(4) After all settings are entered, save the video screen.</p> 	<p><b>▼Reference▲ Tag Reference Manual, 2.23 T-tag (Touch Panel Input)</b></p> <p>T-tags have the following features on a video screen.</p> <ul style="list-style-type: none"> <li>Bit operation</li> <li>Set</li> <li>Reset</li> <li>Momentary</li> <li>Word Operation Mode</li> <li>Set 16 bit</li> <li>Set 32 bit</li> </ul> <p><i>Interlock and Reverse display features are not available.</i></p> <p><b>▼Reference▲ 1.1.3 ■ Saving a Screen</b></p> <p>You must set at least one Video Setting tag on the video screen. If you do not, the screen cannot be saved.</p>

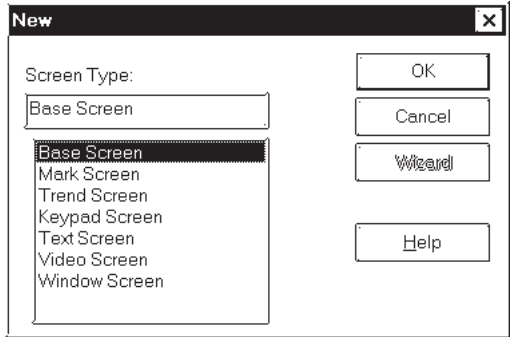
■ Enter v-tag Settings

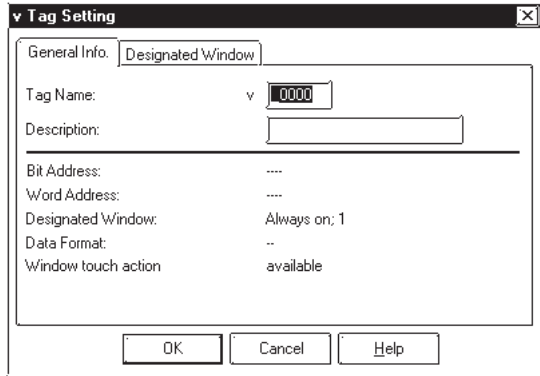
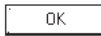
PROCEDURE	REMARKS
<p>(1)Open a Base Screen.</p>  <p>(2)Select the [Tag] menu - [v-tag] command, or click on the  icon.</p>  <p>(3)After all v-tag settings are entered, click on the  button.</p>	<p><b>Reference</b> <i>Tag Reference Manual, 2.28 v-tag (Extended Video Window Display)</i></p>

■ Use the [GP Setup] area's [Video Setting] selection

PROCEDURE	REMARKS
-----------	---------

(1) Click on the Project Manager's **GP Setup** icon, or click on the [Screen/Setup] menu's [GP Setup] selection.



(2) Click on the [Extended Settings] tab and then click on the [Video Settings] button.

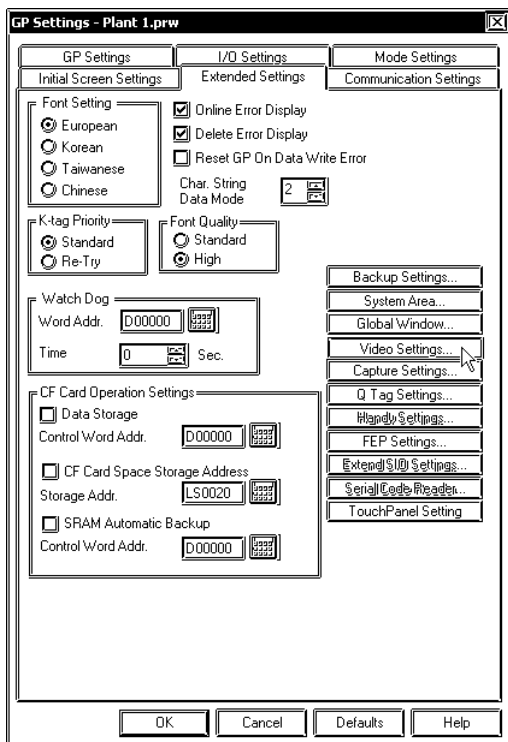

(3) Specify settings for the parameters on [Video Setting].

**Reference** 3.6.1 Video Settings

### 3.6.1 Video Settings

This section describes the procedure for specifying the Video Setting. Select Standard or Extended Mode according to the GP Type.

**Note:** Only "Standard Mode" can be enabled with the GP-570VM and GP-870VM.

Used in the GP570VM and GP870VM. Cannot be used via a v-tag, only with a V-tag.

This feature is used with the GP2000 series unit's [Extend] mode. It cannot be used via a V-tag, only with a v-tag.

Designate whether a Video Control Start Address is used or not. Enabled only in [Extend] mode.

**Reference** Tag Reference Manual, 4.13 Extended Functions of VM Unit

Set when the Video Window is used as a Global Window.

**Reference** 3.6.2 Video Window Settings

#### ◆ Video Control Start Address

This area (Video Control Area) is used to designate the various control features for the display of the video screen on a GP.

**Reference** Device/PLC Connection Manual, 1.1.2 LS Area Structure

Use the following table when setting the Video Control Area's start address.

Mode	Video Control Area Start Address
Standard	LS20 to LS2010, LS2096 to LS4072 (to LS8170 for GP2000 series units)
Extend	LS20 to LS1989, LS2096 to LS4053 (to LS8149 for GP2000 series units)

In Standard mode, 22 words are automatically allocated for the Video Control Area, starting from the Start Address. In Extend mode, 43 words are allocated.

**Reference** Tag Reference Manual, 4.13.3 Standard Mode

**Reference** Tag Reference Manual, 4.13.4 Extended Mode

#### ◆ Center Zoom

Clicking on this selection, if the mode is changed from Standard to Zoom, designates that the center of standard mode's video screen will be enlarged. This selection is enabled only in Extend mode.

◆ **Video Input/Display Mode**

Used to designate the type of input signal and display mode used.



**Note:** Display Mode (from a PC) cannot be used if this screen is set to Extend Mode.

◆ **Brightness/Contrast/Tone/Mode**

Used to designate the GP display settings used for each input channel.

**3.6.2 Video Window Settings**

This selection is used when using the video window as a global window. The setting method is the same as that used for Global Window. When global mode is used, however, the local v-tag cannot be used. The control address used is the user's designated area.

■ **Absolute**

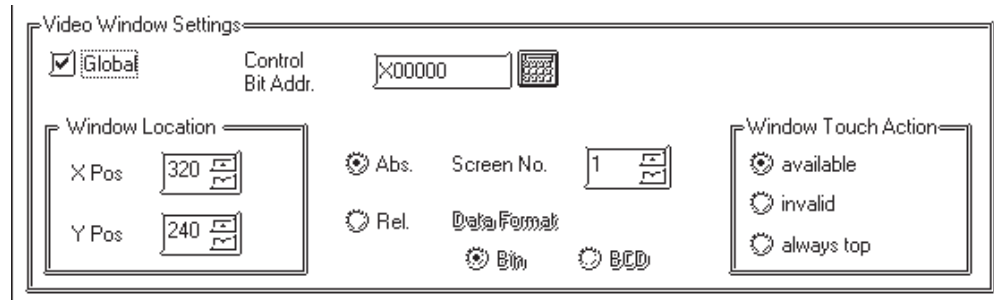

◆ **Control Bit Addr.**

When this bit is designated as “0”, the window is not displayed. When it is “1”, the window will appear.

◆ **Window Location**

This position uses the absolute value of the data entered to designate the video window's top left corner. At this time, that point becomes the video screen's zero (0,0) point.

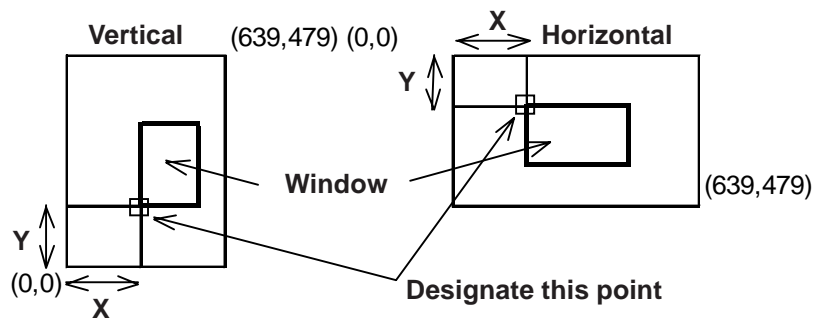

◆ **Screen No.**

Designate the screen number of the video screen to be displayed.

◆ **Window Touch Action**

- Available** If the desired window is currently behind another window, touching anywhere on the desired window will bring that window to the front.
- Invalid** If the desired window is currently behind another window, touching anywhere on the desired window will have no effect and the window will remain in its current position.
- Always top** This setting keeps the desired window always on the “top” (front most) of the display. However, if the GP unit’s system window is used (display of parameters, errors, alarm messages, etc.), this screen will be placed behind the system window

■ **Relative**

This setting uses a variable to designate the display screen and the display position. Thus, as data is saved to the designated Word Address, the display will change.

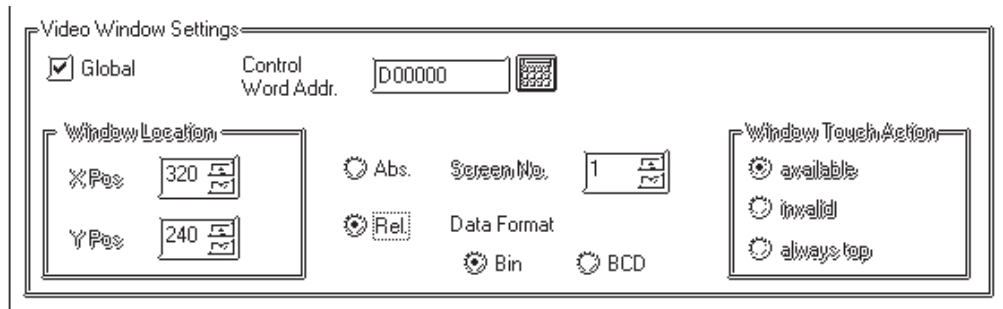

◆ **Control Word Addr.**

When this bit is designated as “0”, the window is not displayed. When it is “1”, the window will appear.

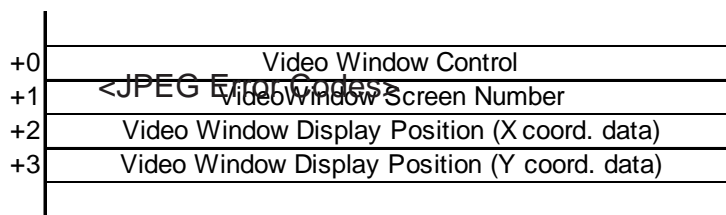

[Window Control]

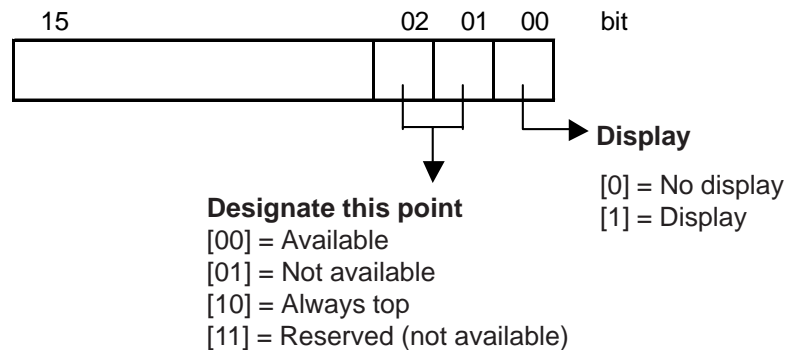

#### ◆ Data Format

BIN

BCD

Designates the type of data used for the display position and window number data.

## 3.7 Window Display: Window (U) Screen and Base (B) Screen

### 3.7.1 Overview of Window Display

Call up the windows registered on the Window Screen (U) or Base Screen (B) and display them on the Base Screen (B).

Additional windows can be displayed on the GP screen when necessary.

Example: Make the settings for displaying a bar graph by turning ON the window display switch.

<GP Screen>

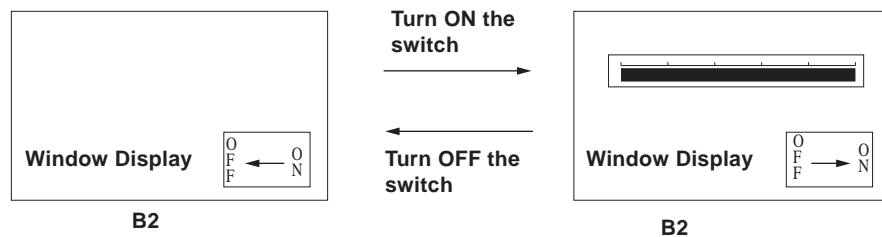

<GP-PRO/PB III Screen Editor>

1) Registering a window on the U Screen

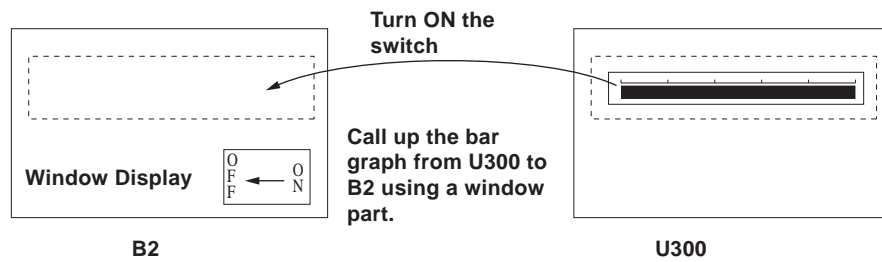

2) Registering a window on the B Screen

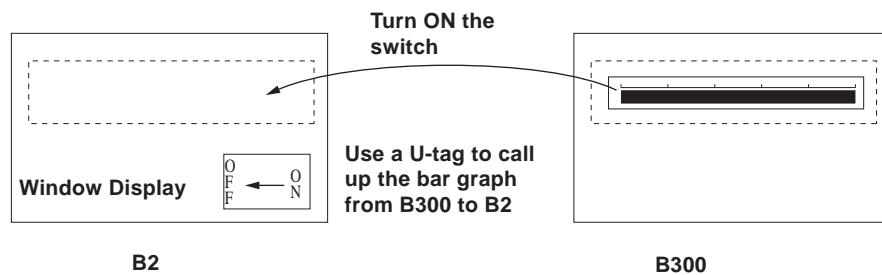



Window Registration can be performed on the Window Screen (U) or Base Screen (B).

The following two types of Window Display are available.

◆ **Local Window Display**

Set up a U-tag to call up a window registered on the Base Screen (B) to the Base Screen (B).

▼ **Reference** 3.7.3 *Window Registration on the B Screen*  
*Tag Reference Manual, 2.26 U-tag (Window Display)*

Set up a window part or a U-tag to call up a window registered on the Window (U) to the Base Screen (B).

▼ **Reference** 2.1.26 *Window Parts, 3.7.2 Window Registration on the U Screen, Tag Reference Manual, 2.26 U-tag (Window Display)*

	Window registered on the B Screen	Window registered on the U Screen
Window part	Not available	○
U-tag	○	○

◆ **Global Window Display**

Displays a single window on all Base Screens (B) as a global window. To call up the window, make the "Global Window" settings on the OFFLINE settings of the GP unit or on the [GP Setup] of the Program Manager in GP-PRO/PB III..

▼ **Reference** *Tag Reference Manual, 2.26 U-tag (Window Display), GP series User Manual, 5.3.3 Global Window Setup*



***K-tags, U-tags, V-tags, v-tags, trend graphs (T Screen and parts), Keypad Input Display, Logging Display, CSV Display and File Manager Display will not function from the registered window.***

### 3.7.2 Window Registration on the U Screen

Call up a window that has been registered on the Window Screen (U) onto the Base Screen (B)

The window can be easily called up with the window part placed on the Base Screen pasted to the Base Screen.

#### ■ Window Screen

Usage Pattern			
[Screen]	→	[New Screen]	→ OK → Create a window.
[Part]	→	[Window Part]	→ Specify the window. → Place.
		or	
			

This section describes the procedure for calling up a window display of a bar graph onto B2, following the example in the section Overview of Window Display in 3.7.1.

## PROCEDURE

## REMARKS



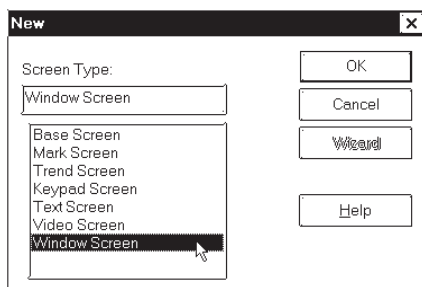

- (1) Select [New] from the [Screen] menu, or click  to select [Window Screen]. The Window Screen (U) opens and a window area with a square frame is displayed.

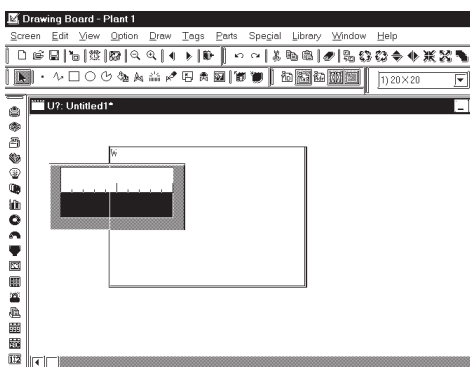

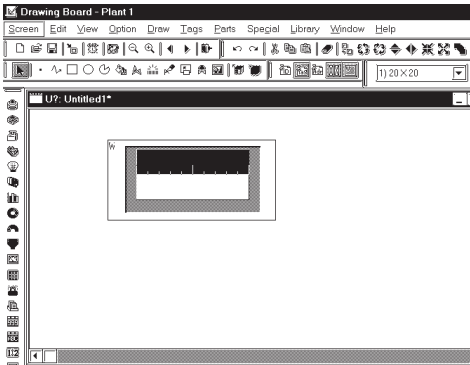

- (2) Draw the bar graph to be called up to the B2 screen.

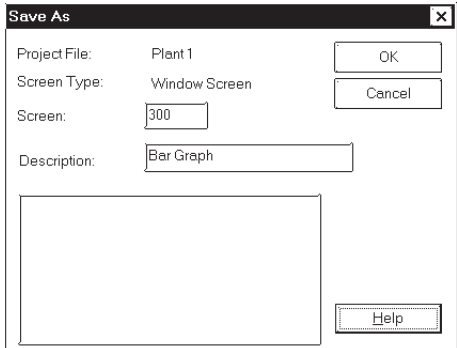
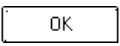

Click the border of the window area and eight ■ will appear on the screen. With the mouse, drag ■ to change the size of the window area.

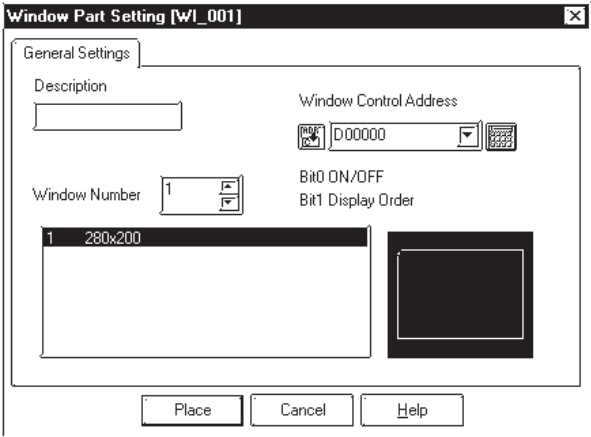
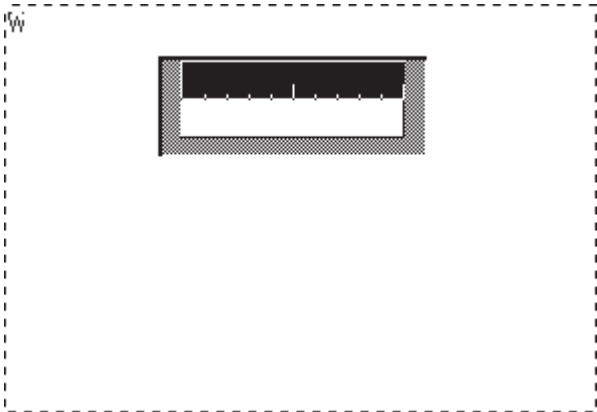
PROCEDURE	REMARKS
<p>(3) Adjust the window area so that it surrounds the bar graph.</p> 	<p>The x coordinates for the window display can only be set up in 8 dot intervals, i.e. the cursor will snap from one 8 dot unit to another. You can set up the Y coordinates anywhere you wish.</p>
<p>(4) Save the Window Screen (U). Select the [Save As] command from the [Screen] menu, or click .</p> 	
<p>Enter the "Screen Number" and "Title." Click the  button.</p>	<p>The Window Registration number that is added to the B Screen (displayed in red if it is already registered) cannot be selected as the "Screen" number.</p>
<p>(5) Open the Base Screen (such as B2) to be used for the window display.</p>	<p><b>Reference</b> 3.7.3 <i>Window Registration on the B Screen</i></p>
<p>(6) Select [Window Parts] from the [Parts] menu, or click .</p>	<p>A U-tag can be used as well to display the Window Screen onto the Base Screen.</p> <p><b>Reference</b> <i>Tag Reference Manual, 2.26 U-tag (Window Display)</i></p>

PROCEDURE	REMARKS
<p>(7) Select the window to be displayed from the "Window Number" field. Specify the Window Control Address as well.</p>  <p>(8) Click the [Place] button after setting all attributes. The border of the window area is displayed on the drawing area.</p> <p>(9) Click on the position where the window is to be placed.</p> 	<p>[Window Control Address]</p> <p>15                      02 01 00 Bits</p>  <p><b>Changing the order of window layers</b> [0]: Touching the window will change the order of the layer. [1]: Touching the window will NOT change the order of the layer.</p> <p><b>Show</b> [0]: Hide the window [1]: Show the window</p> <p><b>Reference</b> <i>Tag Reference Manual, 2.26 U-tag (Window Display)</i></p> <p>A maximum of one global window and two local windows can be displayed simultaneously on a single Base screen.</p> <p>If the specified position overlaps the objects on the Base Screen, the objects are hidden while the window is displayed.</p>

### 3.7.3 Window Registration on the B Screen

To display a window during the GP's RUN mode, you must first register it; the window can be either all or part of a Base screen.

There are two types of window displays, Global and Local, and both are registered and deleted using the same methods.

**Reference** *Tag Reference Manual, 2.26 U-tag (Window Display)*

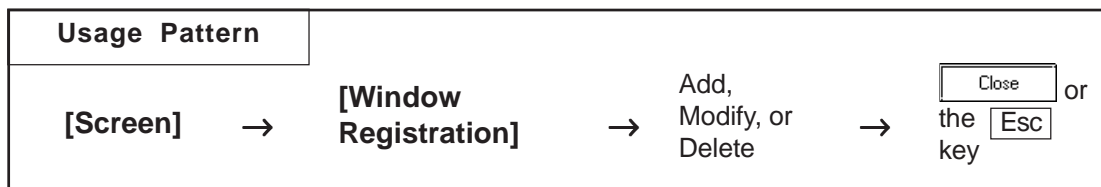

**Lists the Window's registration information**

**Adds new window registration data**

**Modifies window registration Size and/or Description**

**Copies a registered window**

**Deletes a registered window**

No.	Screen	Size	Description
1	1	056x059	Data Entry Keypad
2	12	056x059	Setting Entry Keypac

**Note:** Windows registered on the U Screen are displayed in red. Editing, deleting and copying are not available here.

#### ■ Registering Windows

Here, an additional window can be registered. When clicking on the  button, the window registration setting dialog box will appear.

**Reference** Refer to next page: **■ Registering a Window**

**■ Deleting Windows**

This command deletes a registered window. Use the above dialog box to select the window to be deleted, then click on the  button and a dialog box will appear to confirm your command. Click on the  button to delete the window; click on the  button to cancel the command.

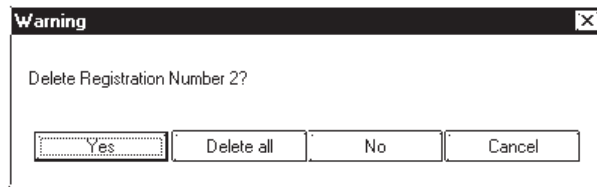

**■ Editing Windows**

Screens registered as a window can be edited, and their names can be changed. First, select the window to be changed from the Window Registration of the Registration list; then, click on the  button. The coordinates of windows are changed in the same manner as adding a window. After the window's coordinates have been designated, the [Add To List] Dialog box will appear and the title can be changed. When the  button is clicked on, the changed items will be registered. To cancel the changes, click on the  button.

**▼ Reference** ■ *Registering a Window, steps (3) to (5)*

If a registered window is copied, the same area (location) of another window can be registered as a window. Any registration number, screen number being registered, and title can be changed.

**▼ Reference** ■ *Copying Window Registration Data*

**■ Registering a Window**

Here, part or all of a screen is registered as a window.

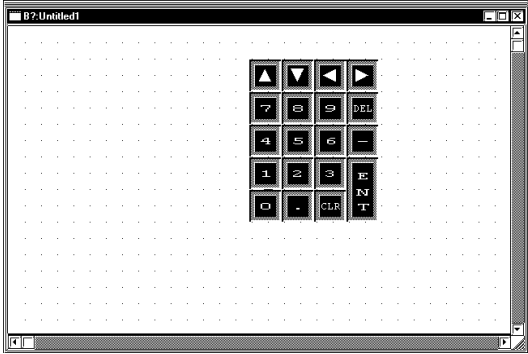
PROCEDURE	REMARKS
<p>Open the screen to be registered as a window.</p> 	

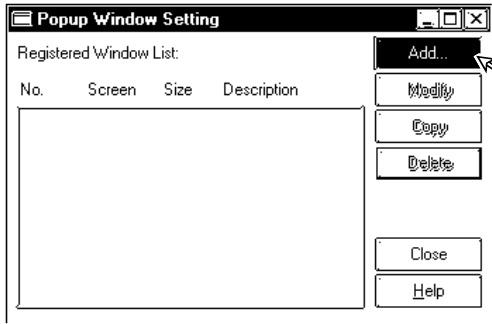
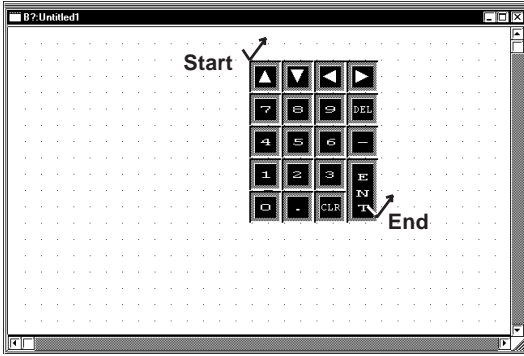
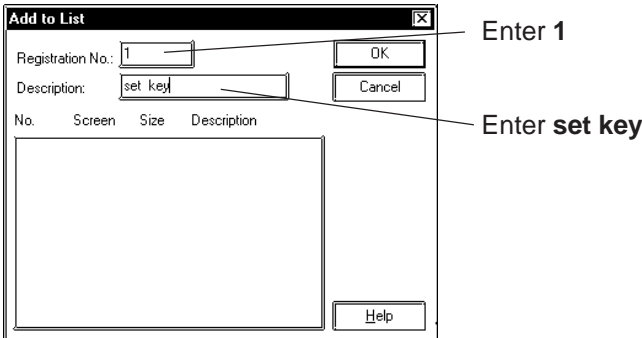

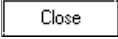
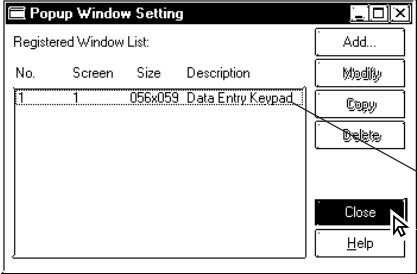
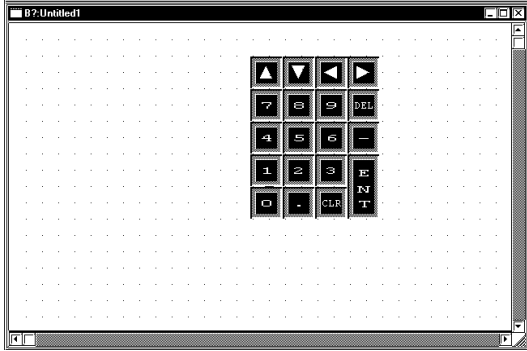

PROCEDURE	REMARKS
<p>(1) Select pull down menu [Screen]'s [Window Menu].</p> <p>(2) Click on the <input type="button" value="Add..."/> button.</p>  <p>(3) Designate the area that you wish to register by Left-dragging the cursor to enclose it.</p>  <p>(4) Enter the Registration No. and title, and then click on the <input type="button" value="OK"/> button. The window will be registered.</p> 	<p>When you are working on a new screen that has not been saved, and you attempt to Add (register) a window, the [Save As...] dialog box will appear. First, you must save the screen, then you can register the window.</p> <p><b>Reference</b> 1.1.3 ■ <i>Saving a Screen Under a Different Name, step (2)</i></p> <p><b>Reference</b> 2.2.3 <i>Square/Rectangle</i> ■ <i>Drawing a Square/Rectangle</i></p> <p>The x coordinates for the window display can only be set up in 8 dot intervals, i.e. the cursor will snap from one 8 dot unit to another. You can set up the Y coordinates anywhere you wish.</p> <p>The "Screen Number" used on the Window Screen cannot be selected as the Registration Number.</p> <p>The Description entered can be up to 30 characters.</p> <p>Windows can be registered up to 1189 for each Project File.</p>

PROCEDURE	REMARKS
<p>(5) Click on the  button to finish registration. When registering another window on the same screen, do not quit here, rather, start again from step (2).</p>  <p style="text-align: center;">↓</p> 	<p>[Window Registration]</p> <p>By changing Size in the Registered Window List of the Popup Window Setting, a larger number of registered items can be displayed.</p> <p>Place the cursor at the bottom-right corner of the screen. The cursor changes to a black arrow. Adjust the size of the dialog box while holding the left mouse button.</p>

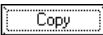
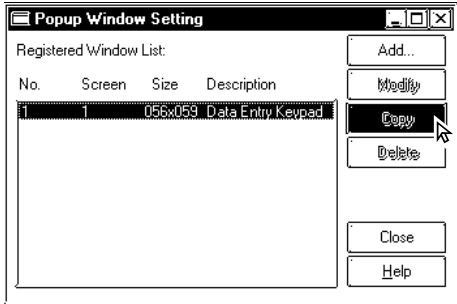
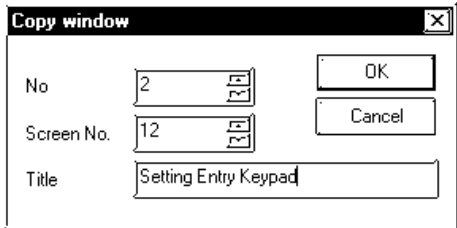

**■ Copying Window Registration Data**

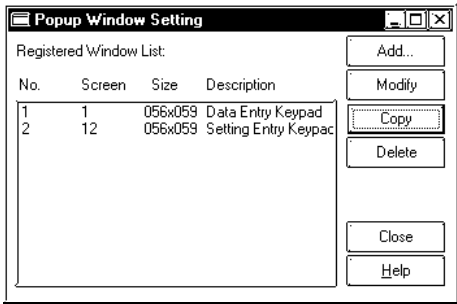
If a registered window is copied, the same area (location) of another window can be registered as a window.

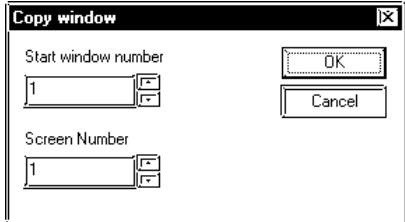
PROCEDURE	REMARKS
<p>(1) Select the [Screen] menu - [Window Registration] command.</p> <p>(2) Select a window to be copied, and then click on the  button.</p>  <p>(3) Enter the registration number of a new window, the screen number to which the window is to be copied, and that screen's title.</p>  <p>(4) Click on the  button to copy the window.</p> 	<p>To select multiple windows at a time, drag through the windows being selected on the list, or select those windows by clicking on them while holding down the  or  key.</p> <p>If multiple windows have been selected in step (2), specify the start window number and screen number of the destination. The window numbers and screen numbers will be assigned relatively so that the smallest window number among those of the source windows corresponds to the start window number.</p> 

## ■ How to Display Windows

The method used for calling up a registered window will differ depending on whether the window's type is global or local.

### ◆ Global Window Display

You can set the "Global Window" area in the [Global Window Setup] from the GP panel's OFFLINE menu or you can use the Global Window dialog box, located in the GP-PRO/PBIII Project Manager screen's [GP Setup]'s [Extended Settings] dialog. Click on the "Global Window" button to bring up this dialog.

**Reference** *Tag Reference Manual, 2.26 U-tag (Window Display), GP Series Users Manual, 5.3.3 Global Window Setup*

### ◆ Local Window Display

Here, a U-tag is used on a Base screen to display a window.

**Reference** *Tag Reference Manual, 2.26 U-tag (Window Display)*

**A**s you use this Screen Editor Software, file management work such as copying and deleting created screens and projects will become easier, thereby improving your work efficiency. This chapter covers “Information Management of your PRO-PB III data.”

<b>4.1</b>	<b>.....Screen Editing</b>
<b>4.2</b>	<b>.....Project Editing</b>
<b>4.3</b>	<b>..... Project Compression/Decompression</b>
<b>4.4</b>	<b>..... Comparing Projects</b>
<b>4.5</b>	<b>..... Information Display</b>
<b>4.6</b>	<b>..... Table Editor Character Strings</b>
<b>4.7</b>	<b>..... Security Feature</b>
<b>4.8</b>	<b>..... Time Schedule</b>
<b>4.9</b>	<b>..... Symbol Editor</b>
<b>4.10</b>	<b>..... Device Monitor</b>

# 4.1 Screen Editing

This section describes the commands used to edit a screen, such as listing screens, and copying/deleting a specified screen.

## 4.1.1 Listing/Copying/Deleting Screen

You can list the number, size and title of all existing screens for each screen type. You can also print out this screen list.

**Reference** 9.1 Print Settings

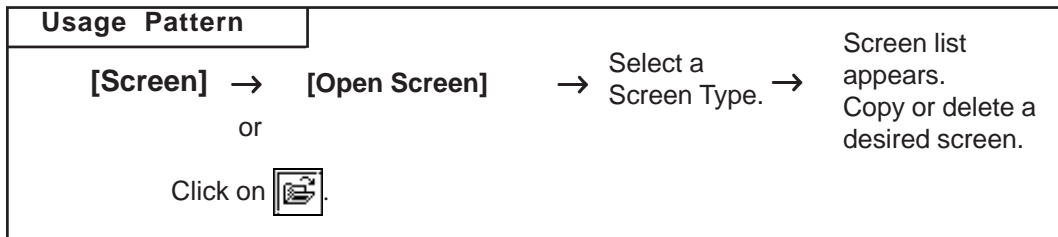

### ■ Listing Screens

This feature lists screens for the current project.

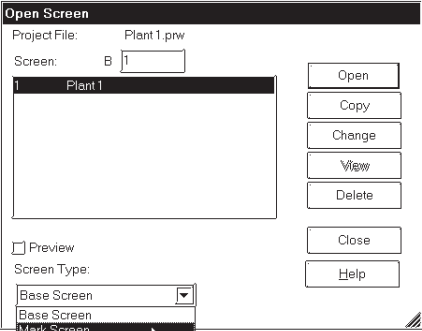
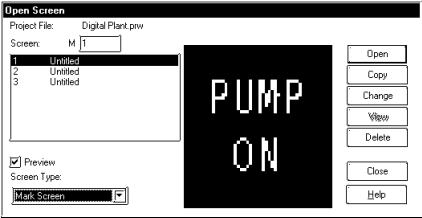
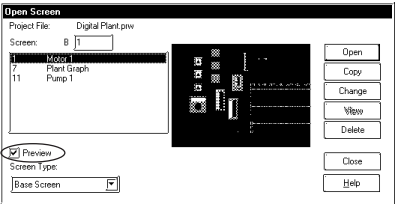
PROCEDURE	REMARKS
<p>(1) Via the Screen Editor, select the [Screen] menu - [Open Screen] command, or click on the  icon.</p> <p>(2) Select the type of screens to be listed. The screens will be automatically listed.</p>  <p style="text-align: center;">When selecting "Mark Screen" from the Screen Type</p> 	<p>By checking the [Preview] check box, the selected screen image can be viewed in the dialog box.</p>  <p>By changing the [Open Screen] dialog box's size, the screen list display area can be enlarged so that more screens can be displayed.</p> <p><b>Reference</b> To print the screen list, refer to 9.1.1 ■ <b>Printing-[Project Information] Tab</b></p>

■ Copying Screens

This feature copies a screen from the current project file.

PROCEDURE	REMARKS
-----------	---------

(1) Via the Screen Editor, select the [Screen] menu - [Open Screen] command, or click on the  icon.

(2) Select a screen to be copied from the list, and click on the  button.

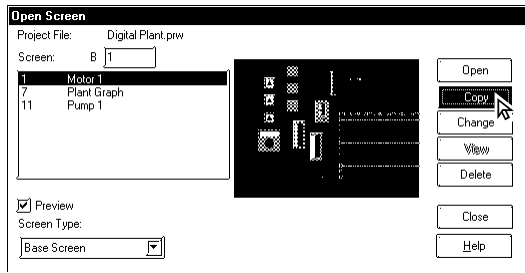

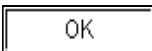
(3) Specify the Start Screen Number of the copy destination and copy count. Then, click on the  button.

The screen will be copied for the designated number, consecutively from the Start Screen No.

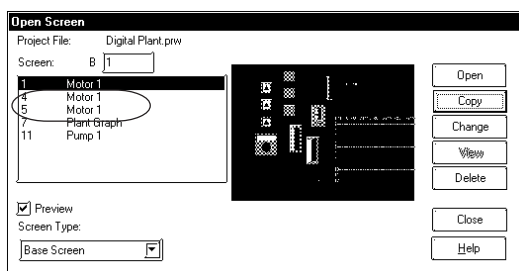
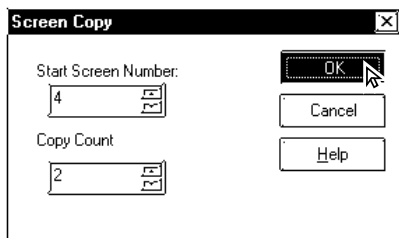

To select several screens simultaneously, drag the mouse down the list, or click on the target screens while pressing your PC's **[Shift]** key or **[Ctrl]** key.





When selecting multiple screens simultaneously, copy will be performed only one time.



**Once the [Copy] command is performed, it cannot be undone.**

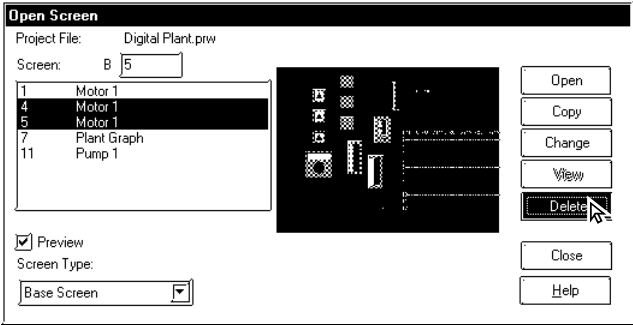
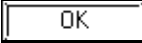
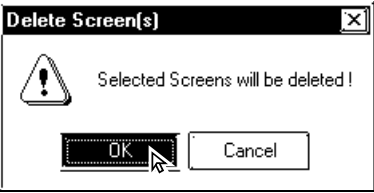
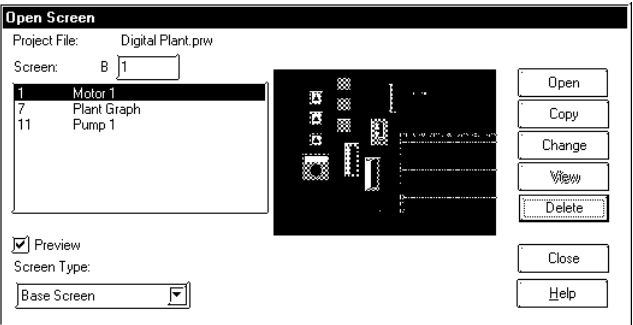

**■ Deleting Screens**

This feature deletes a screen from the current project file.

PROCEDURE	REMARKS
<p>(1) Via the Screen Editor, select the [Screen] menu - [Open Screen] command, or click on the  icon.</p> <p>(2) Select a screen to be deleted from the list, and click on the  button.</p>  <p>(3) Click on the  button to delete the screen.</p>  <p style="text-align: center;">↓</p> 	<p>To select several screens simultaneously, drag the mouse down the list, or click on the target screens while pressing your PC's <b>[Shift]</b> key or <b>[Ctrl]</b> key .</p> <p> <b>Important</b></p> <p><b>Once the [Delete] command is performed, it cannot be undone.</b></p>

■ **Changing Screen Numbers and Titles**

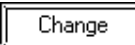
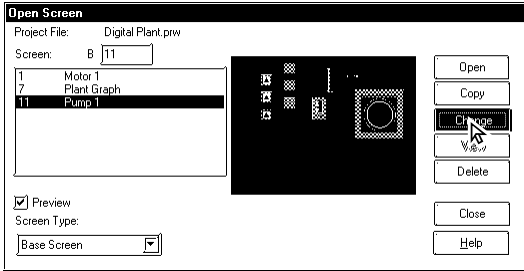
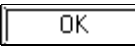
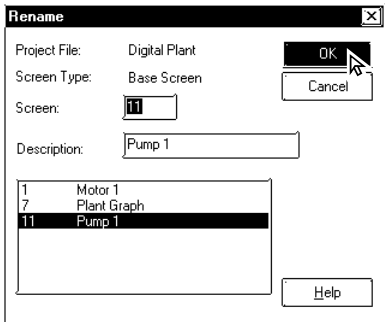
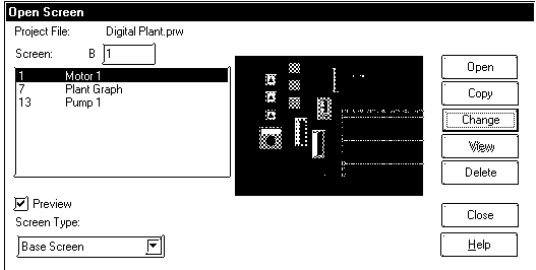
This feature allows you to change screen numbers and titles in the current project file.

PROCEDURE	REMARKS
<p><b>[Changing only One Screen]</b></p> <p>(1) Via the Screen Editor, select the [Screen] menu - [Open Screen] command, or click on the  icon.</p> <p>(2) Select a screen to be changed from the list, and click on the  button.</p>  <p>(3) Change the screen number and title, and then click on the  button to delete the screen.</p>  <p style="text-align: center;">↓</p> 	<div style="text-align: center;">  <p><b>Important</b></p> </div> <p><i>If any existing screen number is specified, it will be overwritten.</i></p> <p>The currently open screen cannot be changed.</p>

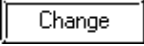
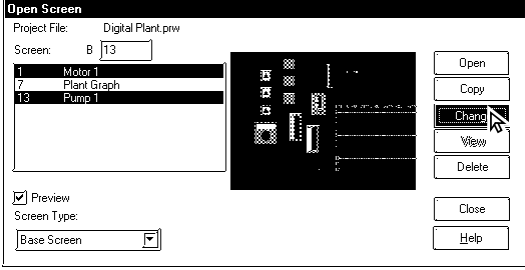
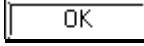
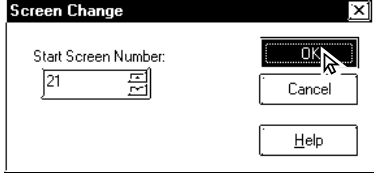
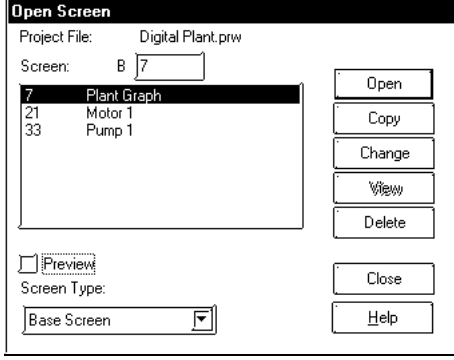
PROCEDURE	REMARKS
<p><b>[Changing Multiple Screens at a Time]</b></p> <p>(1) Via the Screen Editor, select the [Screen] menu - [Open Screen] command, or click on the  icon.</p> <p>(2) Select multiple screens to be changed from the list, and click on the  button.</p>  <p>(3) Specify the start screen number at the destination, and then click on the  button.</p> <p>“21” is specified here.</p> <p>The specified number comes to the top, and the subsequent numbers are changed automatically with increments of offset values.</p>  <p style="text-align: center;">↓</p> 	<p>To select multiple screens at a time, drag the mouse through the desired screens on the list, or click on those screens while holding the <b>Shift</b> or <b>Ctrl</b> key down.</p> <p>The currently open screen cannot be changed.</p> <p>The difference between the start screen number at the destination and that at the source is taken as an offset value. Since the start screen number, 1 is to be changed to 21 here, the offset value is 20. This offset value is added to the subsequent screen number 13, which is then changed to 33.</p>



### 4.1.2 Copying Screens from Other Projects

Screens created in any project file other than the currently open one, and other settings can be copied to the currently open screen.

#### ■ Specifying Items to Be Copied

After selecting a project file as the copying source, specify the items you want to copy, such as the screen area to be copied and other settings, and a copying method. These screens and settings can also be printed out.

▼ **Reference** ▲ 9.1 Print Settings

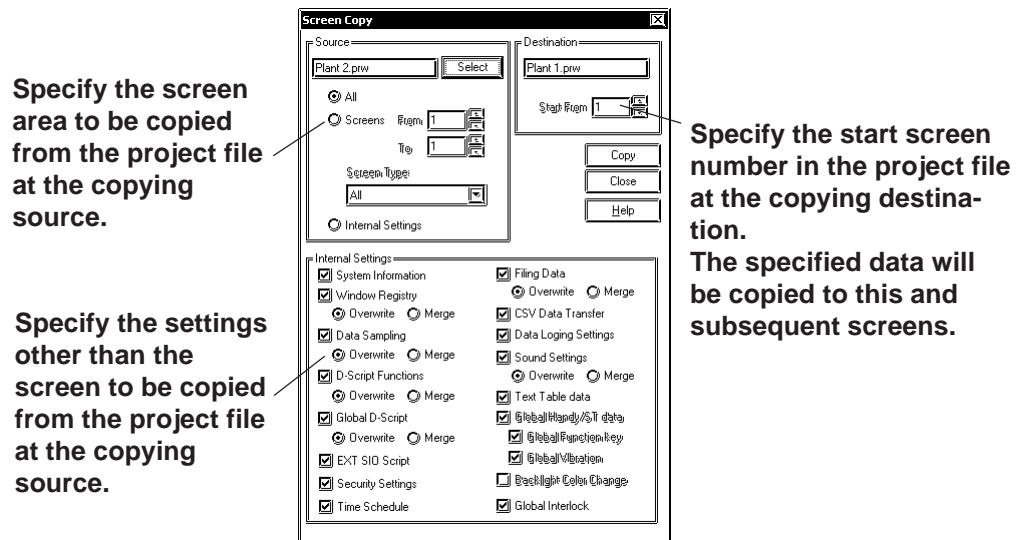

#### ◆ Source

The project file selected as the copying source is displayed. Specify the screen area to be copied and a screen type. If you are not copying a screen, but other settings only, select [Internal Settings].

#### ◆ Destination

The current project file is displayed. When copying a screen from another project file, specify the start screen number in the project file at the copying destination to start copying the screen.

#### ◆ Internal Settings

Select the items to be copied among the global settings for each project file, which are not dependent on any screen. Also specify whether the settings existing in the current project file are deleted by overwriting them or merged (added) with additional settings without deleting them. If "Overwrite" is specified, the settings at the copying destination will be deleted and all the settings at the copying source will be copied. If "Merge" is specified, the settings at the copying source will be copied while those at the copying destination are left as far as possible.

When such a merge is made using [Window Registry], [D-Script Functions], or [Filing Data], you will be prompted to confirm whether any identical existing number or function name is to be overwritten. When the combination is made using [Data Sampling], [Global D-Script], or [Sound Settings], all the settings will be merged.

## PROCEDURE

## REMARKS

First, open the copy designation project.

(1) Select the Project Manager's [Utility] menu - [Screen Copy] command.

(2) Select the project file to be copied (original project file) from the screen list, or enter the target project name, then click on the  button.

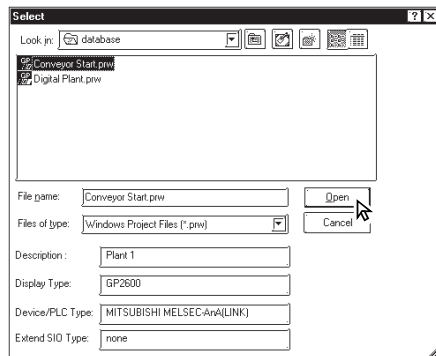

(3) Enter the screen type and screen number of the original screen.

Those screens corresponding to the specified initial screen number through the final screen number will be copied.

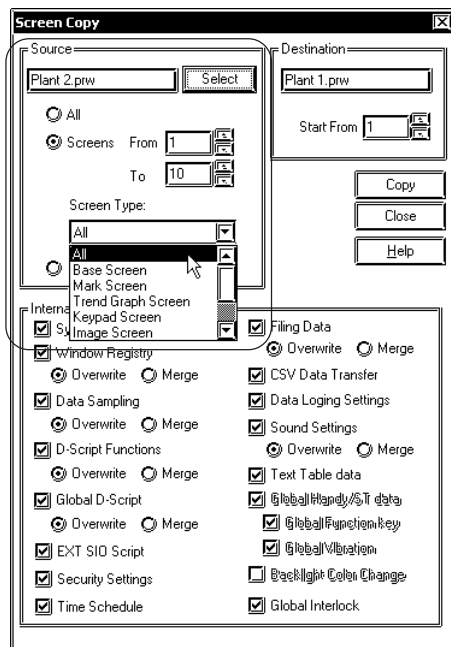

To select a screen located in a different folder, you must change to that folder.

**Reference** 1.1.2 ■ *Selecting an Existing Project*

The currently opened project cannot be selected.

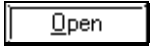
When you double-click on the project name selected in step (2), you can skip the  command.

<When [All] is selected>

All screens in the Project are copied.

<Notes on copying windows registered with the Window Screen or Base Screen>

(1) When copying a window registered with the Window Screen, select [All], or specify the Screen Type as "Window Screen" under the [Screen From/To] option in the [Source] field.

(2) When copying a window registered with the Base Screen, check the "Window Registry" option in the "Internal Settings" field.

<When Windows of the same No. exist in the both the Source and Destination Projects>

A window registered with the Base Screen cannot be copied onto a window registered with the Window Screen.

## PROCEDURE

## REMARKS

**(4) Enter the screen type and screen number of the destination screen.**

The screens will be copied to the Destination project, starting from the specified initial screen number onwards.

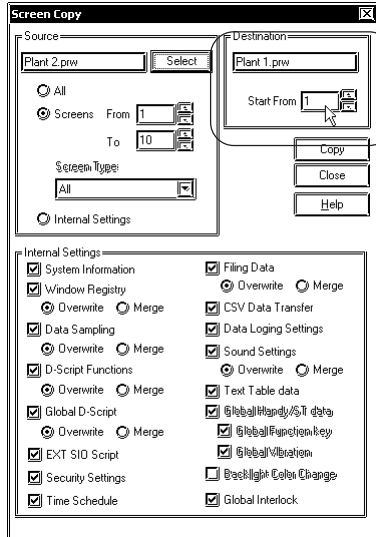
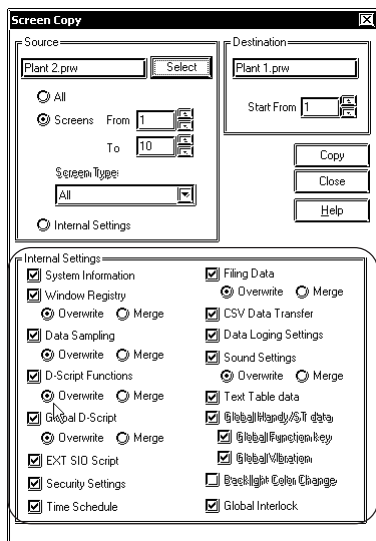
**(5) Select the internal settings to be copied, and specify the copying method (overwrite or merge).****(6) After confirming your selection and designation, click on the  button.**

If there is any screen of an identical number or function name, you will be prompted to conform whether or not to overwrite it. Selecting  will overwrite such a screen or function name, and selecting  will proceed to the next question. If  is selected, all the screens or settings will be overwritten. If  is selected, only the screens or settings that do not exist at the copying destination will be copied.

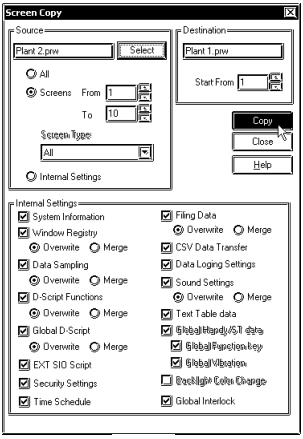
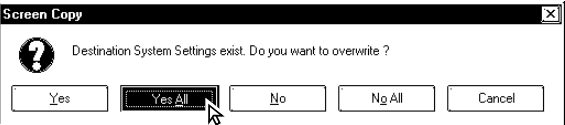
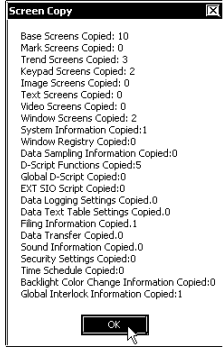
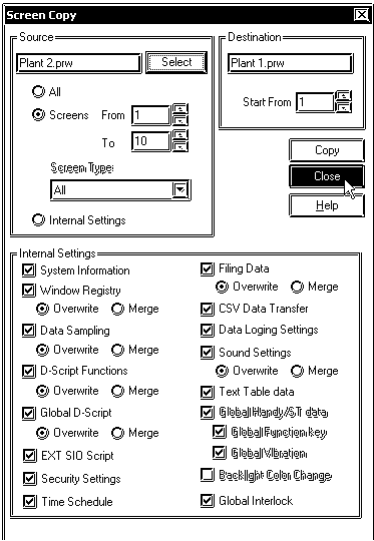
PROCEDURE	REMARKS
 <p style="text-align: center;">↓</p> 	
<p><b>(7) Click on the <span style="border: 1px solid black; padding: 2px;">OK</span> button to exit the screen copy mode.</b></p> <p>The number of screens copied will be displayed in the dialog box.</p> 	<p><i>After replacing the screens, you must re-enter all Tag device addresses.</i></p> <p>To subsequently copy any other screen in the same project file, repeat the procedures starting with step (3).</p>
<p><b>(8) Click on the <span style="border: 1px solid black; padding: 2px;">Close</span> button.</b></p> 	

## 4.2 Project Editing

### 4.2.1 Deleting Project Files

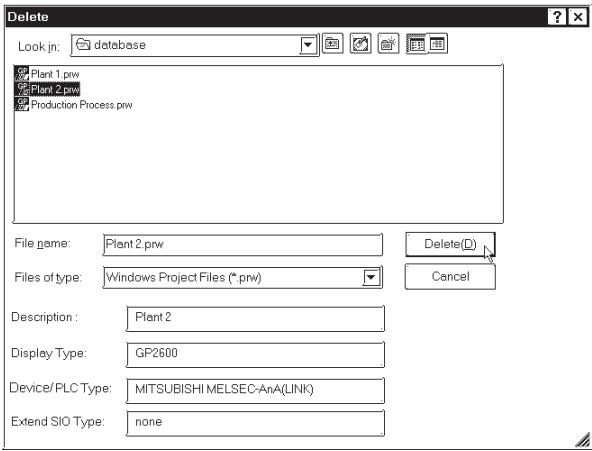
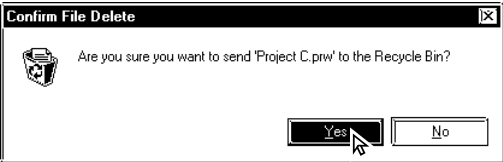

This feature allows you to delete a project file.

PROCEDURE	REMARKS
<p>(1) Via the Project Manager, select the [Project] menu - [Delete] command.</p> <p>(2) Select the project to be deleted from the screen list, or enter the desired project's file name. Then, click on the <input type="button" value="Delete(D)"/> button.</p>  <p>(3) Click on the <input type="button" value="Yes"/> button to delete the project.</p> 	<p>To select a project located in a different folder, change the directory to that folder.</p> <p><b>Reference</b> 1.1.2 ■ <i>Selecting an Existing Project</i></p> <p>When you double-click on the project name selected in step (3), you can skip the <input type="button" value="Delete(D)"/> command.</p> <p><b>Important</b></p> <p><b>Once the [Delete] command is performed, it cannot be undone.</b></p>

### 4.2.2 Backing up Project Files

When a Project file is saved, a backup file (\*.bak) of the most recently saved Project file data is created. The backup file is created in the same folder in which the selected Project Manager is stored.

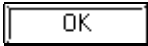
To open and edit Backup files as Project files, change the filename extension to "prw".

PROCEDURE	REMARKS
<p>(1) In the Project Manager (such as A PLANT SYSTEM.prw), select the [Project] menu's [Backup Settings] command.</p> <p>(2) Put a check mark in the "Backup Project File" checkbox and click on the  button.</p>  <p>(3) Save a Project file. The backup file [A PLANT SYSTEM.bak] is created in the same folder in which the selected Project Manager (Example: A PLANT SYSTEM.prw) is stored.</p>	<p>The option is enabled in the initial settings.</p> <p>To open and edit Backup files via the Project Manger, change the filename extension from "bak" to "prw".</p>

### 4.2.3 Rebuilding A Project (Rebuild)

The “Rebuild” tool is used to both check the contents of the PRW files, PRO files, CPW files, CPL files and MRK files created with GP-PRO/PB III for Windows, as well as to rebuild these files if the following conditions occurred.

In the following cases, use the “Rebuild” command to restore file data.

1. Your personal computer is either reset or shut down while you are saving data.
2. The system crashed while you were saving data.
3. Your floppy disk or hard disk is damaged.
4. Your personal computer’s disk drive is defective.
5. A system error (an error not specified in the error message list, such as a partition or checksum error) occurs while a screen is being opened or transferred.
6. The desired project file does not display as a PRW file during project selection, or an existing screen’s number is not displayed when you try to open that screen.
7. You cannot select a project file when you try to perform the [Select Project] command. (i.e. the GP-PRO/PB III for Windows program cannot recognize the project file as a PRW file)
8. When you try to open a file, an error message appears, indicating that the file is damaged.

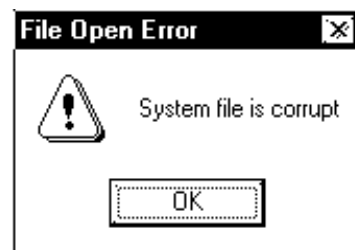

9. Parts and Tags placed on the GP-PRO/PB III for Windows program screen cannot be displayed on the GP unit, or, a different screen than desired is displayed on the GP unit. (i.e. the relationship between the screen data and Parts data is not correct)

If the above error message is displayed, GP-PRO/PB III for Windows program cannot read the target file until this file is rebuilt.

If a file’s data cannot be completely restored with the “Rebuild” tool, the system treats this data as abnormal data and deletes it. In this case, you must edit this PRW file using GP-PRO/PB III for Windows program after the “Rebuild” command is performed.



**File Rebuilding requires approximately three times the hard disk space occupied by the Project file.**

**Protected PRW files cannot be rebuilt. It is necessary to remove the Protect setting before rebuilding. For details about removing Protect settings,**

**Reference** [4.2.9 Protect Settings](#)

■ **Rebuilding**

General description of the “Rebuild” screen is as follows:

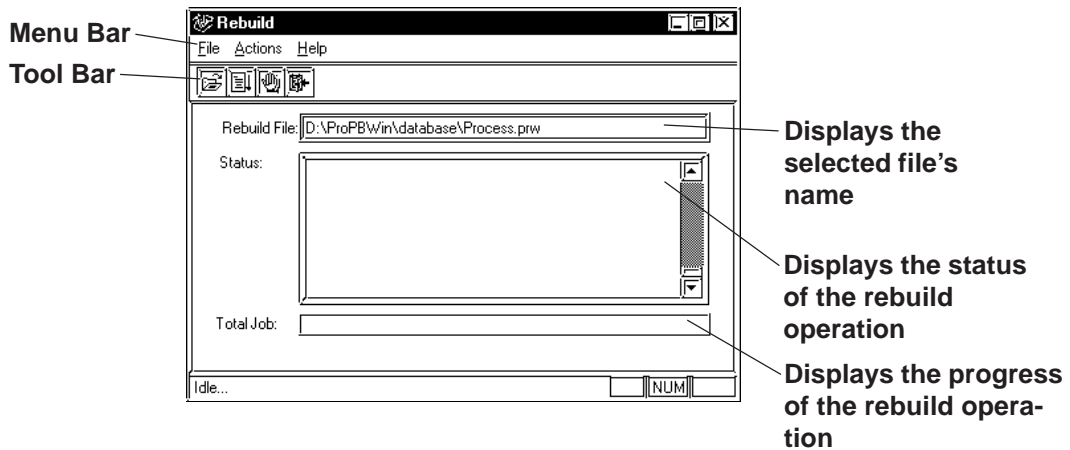

PROCEDURE	REMARKS
-----------	---------

(1) To rebuild a file, select [Rebuild (Data Recover/Optimize)] from the Project Manager’s Utility menu, or click on the Windows main menu’s [Start] button. Point to the [Programs] - [Pro-face] - [ProPB3 C-Package] menu, and select the [3.Rebuild] command.

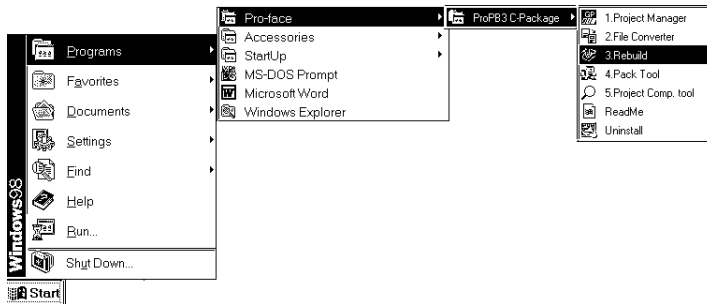



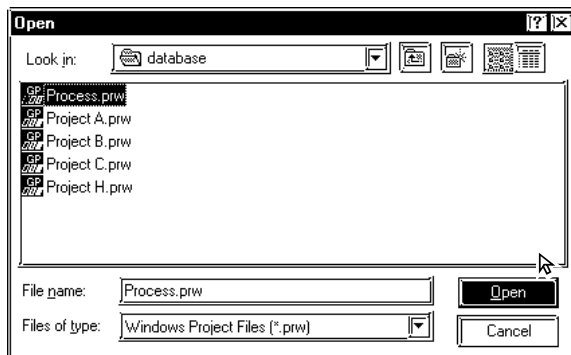

(2) Select the [File] menu - [Open] command, or click on the icon.

(3) Select the file to be rebuilt, or enter the file name. Then, click on the  button.

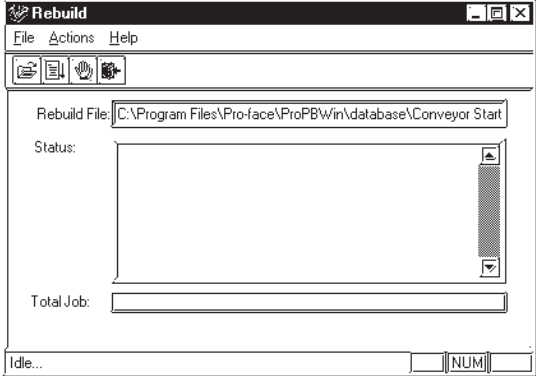
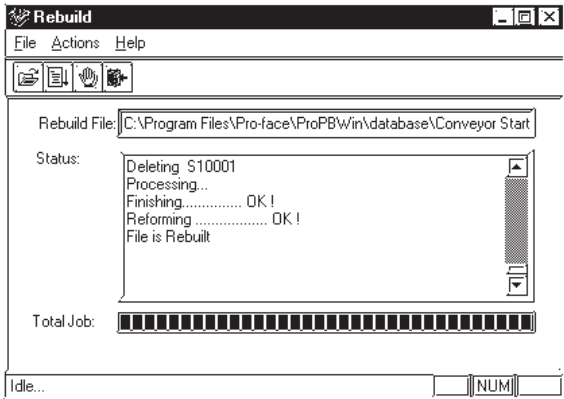



PROCEDURE	REMARKS
<p>(4) After confirming that the file name is correct, select the [Actions] menu - [Start] command, or click on the  icon.</p> <p>The selected file will then be rebuilt.</p>  <p style="text-align: center;">↓</p>  <p>(5) Select the [File] menu - [Exit] command, or click on the  icon and finish the rebuild operation.</p>	<p>To cancel file rebuilding, click on the  icon.</p>

**Note:**  When parts and tags placed on the GP-PRO/PB III screen are not displayed on the GP screen or are displayed in completely different shapes (the parts data is not properly associated with the screen data), execute the Rebuild command and transfer the data again. Select  and choose the [Transfer Settings] command from the [Setup] menu to display the [Transfer Settings] dialog box. Specify the [Send All Screens] option from the [Transfer Method] field.

### 4.2.4 Converting Addresses and Device Codes

This feature allows you to change a Tag's addresses. This address conversion can be performed on either word or bit addresses. This command is useful for changing both addresses or an address' device code.



• When assigning a variable (GLC symbol) to the address do NOT perform the Address Block conversion. Otherwise, the operation will fail.

## PROCEDURE

## REMARKS

(1) Via the Project Manager, select the [Utility] menu - [Convert Addresses] command.

(2) Select the type of the address conversion to perform: Word Address or Bit Address.

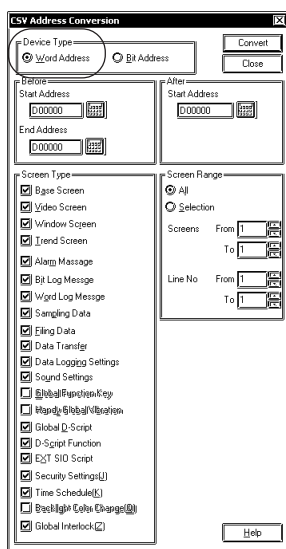

(3) Enter the address conversion range and the updated initial address.

Before this step is performed, be sure that the first and last device codes used are the same. You cannot specify an address conversion range for a different device.

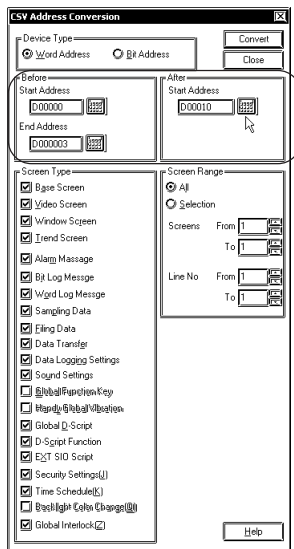

In word address conversion mode, Tag addresses specified by a bit address can also be changed, within a specified range.

When using any of the following PLCs, specify the PLC number, as well:

FACTORY ACE, 1:n communication (Yokogawa Electric Corp.)  
 TOYOPUC-PC2, 1:n communication (Toyota Machine Works)  
 TOYOPUC-PC3J, 1:n communication (Toyota Machine Works)  
 CP9200SH Series (Yasukawa Electric Corp.)  
 SDC Series (Yamatate Electric Corp.)  
 THERMAC NEO series (OMRON)

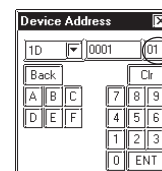





PLC No.

When converting addresses, be sure that the address settings meet the following condition:

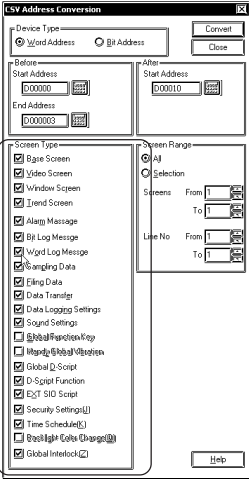
**“Final address before conversion” - “Initial address before conversion” ≤ “Final address after conversion” - “Initial address after conversion”**

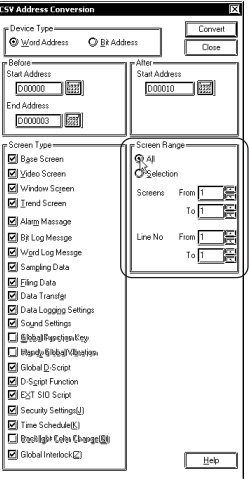
If the left side is larger than the right side in the above formula, the Tags corresponding to the surplus addresses will be assigned to the final address of the same device.

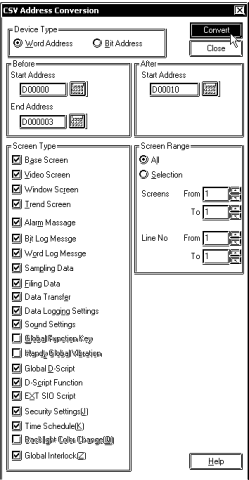
PROCEDURE	REMARKS
<p><b>(4) Select the type of screen to be replaced.</b></p>	
	
<p><b>(5) Enter the screen number to be changed. (Enter the line numbers used in the Alarm Editor)</b>                  All the addresses between the initial screen number and the final screen number (or the addresses between the initial line number and the final line number), will now be changed.</p>	<div style="text-align: center;">   <b>Important</b> </div> <p><b>Do not convert addresses on 2,000 screens or more at a time. Otherwise, the memory capacity might run short after this conversion. If this memory shortage occurs, re-start the GP-PRO/PB III.</b></p>
	
<p><b>(6) After confirming that all the settings are correct, click on the  button.</b></p>	
	

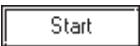
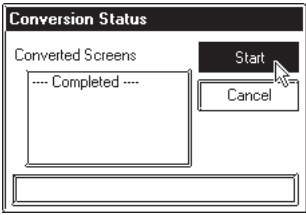
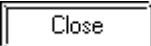
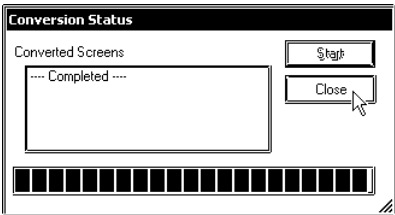
PROCEDURE	REMARKS
<p>(7) Click on the  button. The progress of the address conversion will be displayed.</p>  <p>(8) To stop the address conversion prior to normal completion, click on the  button.</p> 	

### 4.2.5 Convert Load Screens

This feature allows you to convert the currently loaded screens to different ones via the [Load Screen] command, all at once.

#### ■ Load Screen and Search Screen Settings

Here, specify the screens to be converted. Enter the numbers of the Search Screens on which Load Screens have been called up and called up Load Screens.

**Specify the range of Load Screens before conversion.**

**Specify the Top Screen number of the Load screens after conversion.**

**Specify the range of the Search Screens on which Load Screens have been called up.**

**Load Screen Conversion**

Load Screen No.s

Before

Start No.

End No.

After

Top Screen No.

Screen Search Result

Screen

Start No.

End No.

Screen Type

Base

Trend

Keyboard

Mark

Image

Image-CF Card

**Specify the Load Screen Type.**

**Specify the Search Screen Type.**

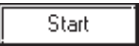
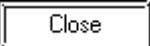

PROCEDURE	REMARKS
<p>Example; Load Screens B100 to B105 currently loaded on Base screens B1 to B30 are converted to B200 to B205.</p> <p>(1) Via the Project Manager, select the [Utility] menu - [Convert Load Screens] command.</p> <p>(2) Specify the type and numbers of the Load Screens to be converted and the Top Screen number of the Load Screens after conversion.</p> <div data-bbox="399 604 949 918"> </div> <p>(3) Specify the range of the Search Screens and their type.</p> <p>The Load Screen numbers specified in step (2) will be converted and called up on Search Screens specified by the Start and End numbers, here.</p> <div data-bbox="399 1153 949 1332"> </div> <p>(4) After confirming all the settings are correct, click on the  button.</p> <p>(5) Click on the  button to start conversion. The conversion status will continuously be displayed.</p> <div data-bbox="247 1594 523 1787"> </div> <p>(6) Click on the  button to close the dialog.</p> <div data-bbox="247 1892 523 2078"> </div>	

**4.2.6** Changing a Project's GP Type

You can change the GP type of your current project.

**Note:** After changing the GP type, you can save the current project using the [Project] menu - [Save As] command.

**Reference** 1.1.2 ■ Saving a Project Under a Different Name

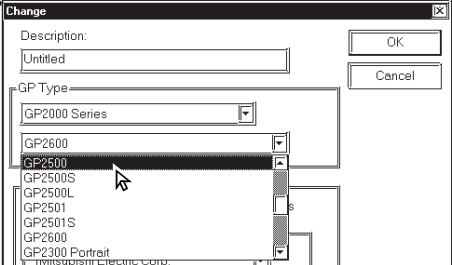
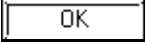
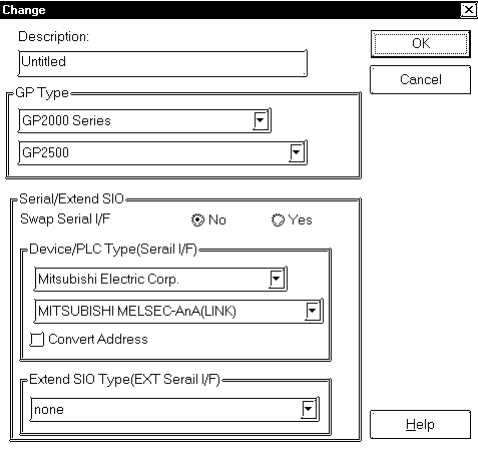
PROCEDURE	REMARKS
<p>(1) Via the Project Manager, click on the  icon, or select the [Project] menu - [Change GP Type] command.</p>  <p>(2) To change the GP type, click on the desired GP type.</p>  <p>(3) Click on the  button.</p> 	<p>Do not open screens other than the Project Manager. Doing so will disable the selection of the GP Type.</p> <p>The drawing area, commands and memory used by this change will vary depending on the selected GP type. Be sure to check these items before changing the GP type to be sure that your change(s) will be compatible with your existing project's data.</p> <p>The GP type cannot be changed from GP/GLC/ST Series to LT Series.</p>



- When a vertical type GP unit is replaced with a horizontal type or vice-versa, the displayed screen is rotated 90°. Therefore, you must also edit the screen using the [Rotate] command. After editing, be sure to check that the displayed data is as desired.

Example)

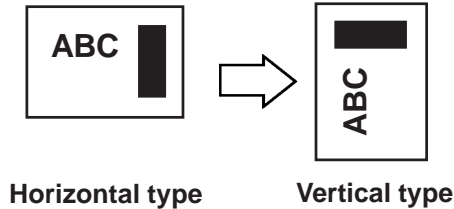

- When a high-resolution type GP unit is replaced with a low-resolution type, data beyond the display range cannot be displayed. If a project file is changed to a low-resolution type and then changed back to the high-resolution type again, data beyond the display range (data that cannot be displayed with the low-resolution type GP panel) will be restored. Before changing the [GP Type] setting, be sure to use the Screen Editor to check the changed display. Select [Option], [Screen Settings] and the [Display Area] tab. Then select the resolution of the new GP Type, and click [OK]. A frame will appear on the Screen Editor to show the display range at the specified resolution. You can then move your data into the frame.
- The maximum number of characters used for an alarm summary differs according to the GP unit screen's resolution. For example, if an alarm message is created for a high-resolution type GP and then changed for the low-resolution type, data beyond the message area cannot be displayed.

### 4.2.7 Changing Your Project's Device/PLC Type and Addresses

The Device/PLC type selected in the current project and the available addresses can be changed.

**Note:** To change the Device/PLC type, save the Device/PLC type you have changed via the [Project] menu-[Save As] command.

**Reference** 1.1.2 ■ Saving a Project File under a Different File Name

#### ■ Changing the Device/PLC type

The Device/PLC type can be changed in the following dialog box. Before changing the Device/PLC type, enable or disable serial interface selection.

A description cannot be entered.

Before changing the Device/PLC type, you must specify either "No" or "Yes" for serial interface selection.

Add a check mark to display a screen that allows you to configure the conversion pattern of available devices.

Select the desired Device/PLC type from the pull-down list.



- When changing the [Switch Serial I/F] setting from "No" to "Yes" or vice versa, the following caution message will be displayed. To make the GP unit recognize the Serial I/F Switch, be sure to send the PRW file as well as the [GP Setup (Y)] to the GP unit.

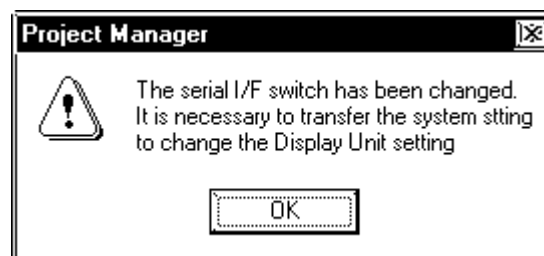

- The default "Serial I/F Switch" setting is "No". Select "No" or "Yes" only when the GP type is set to the GP2000 Series.
- When the GP type is set to the GP2000 Series (GP2301H/GP2401H/GP2301/GP2401/GP2501/GP2601 series) without extended SIO I/F (COM2), specifying "Yes" for Serial I/F Switch prevents a change of device (Extended Serial I/F). This occurs because the Serial I/F (COM1) is used by the Extended SIO Script protocol. For details regarding "Serial I/F Switch", **Reference** 4.2.8 Changing Extended SIO Settings.



## ■ Setting the Device Conversion Pattern

The conversion operation of available devices is executed when the PLC type is changed.

The "Conversion Pattern" should be registered in order to convert the available device.



**Note:** For efficient setup operations, arrange the following items beforehand.

- Tables of available devices/PLCs both before and after the device/PLC types have been changed.

( **Reference** *Device/PLC Connection Manual, Device Memory Map of the PLC, etc.*)

- Printed result of global cross reference

Click this button to execute the conversion according to the data shown in the Address Table.

Address Table Displays detailed information on the conversion patterns (address type, range of available addresses before the PLC type is changed, and start address of the available address after the change).

Click this button to cancel all conversion information in the Address Table.

Click this button to register an additional conversion pattern.

Click this button to modify the settings of the conversion pattern.



Click this button to delete a conversion pattern.

Click this button to load the conversion patterns from the CSV file data and display the data in the Address Table.

Click this button to save the conversion patterns in a CSV file.

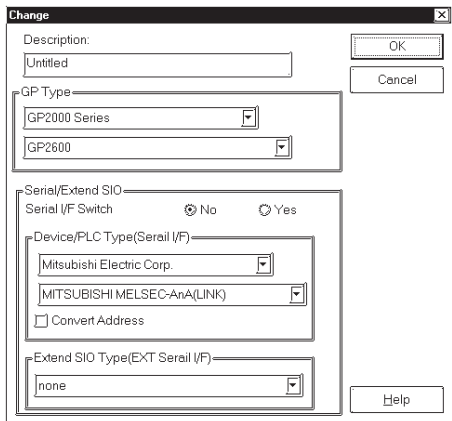
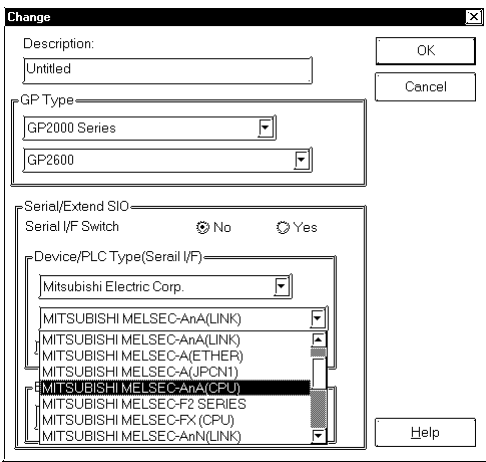

- If the addresses that are not used in the project file are also specified and converted when addresses are converted, it may take some time to convert them. If addresses are converted in the range of the required addresses that are used, the conversion time can be reduced.

PROCEDURE	REMARKS
<p>(1) Via the Project Manager, click on the  icon, or select the [Project] menu - [Change Device/PLC Type] command.</p> 	<p>Do not open screens other than the Project Manager. Doing so will disable the selection of the Device/PLC Type.</p>
<p>(2) Select either "No" or "Yes" for serial interface selection.</p> 	<p>The initial setting of serial interface selection is "No". Select "No" or "Yes" only when the GP2000 Series is used.</p> <p><b>Reference</b> <i>Changing the Device/PLC type</i></p>
<p>(3) To change the Device/PLC type, click on the desired GP type.</p> 	

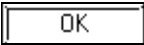
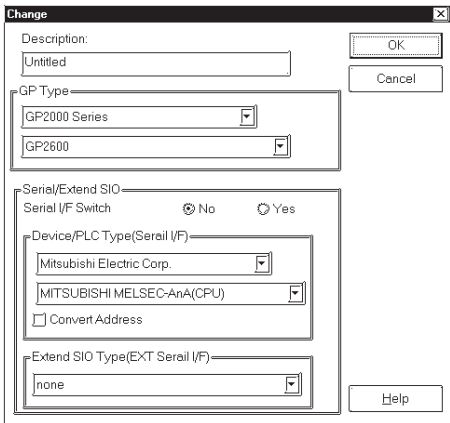
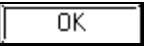
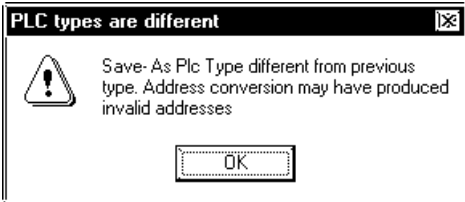
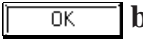
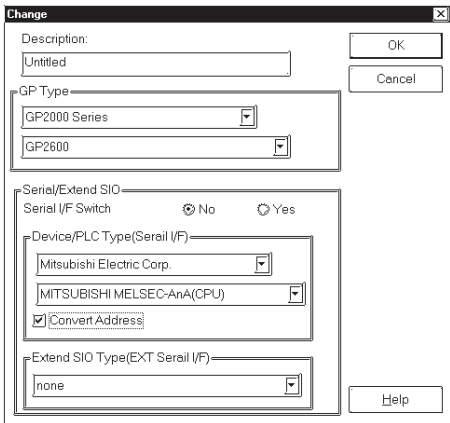
PROCEDURE	REMARKS
<p>[When no Device conversion patterns are set]</p> <p>(4) Click on the  button.</p>  <p>(5) Click on the  button to exit the setting dialog box.</p> 	<p>The conversion operation applies to all addresses in the selected Project (except for addresses that have been registered as symbols).</p> <p>Once you change a project's Device/PLC type, you must re-enter that project's device addresses for Tags, D-script and alarms. Save each screen separately again when the Function Switch set up with the "Change Screen" function is used on the screen.</p>
<p>[When Device conversion patterns are set]</p> <p>(4) Put a check mark in the "Convert Address" checkbox and click on the  button.</p> 	<p>The conversion operation applies to all addresses in the selected Project (except for the addresses that have registered as symbols).</p>

PROCEDURE	REMARKS
-----------	---------

(5) Click on the Add Pattern button to set up the conversion pattern for the Device.

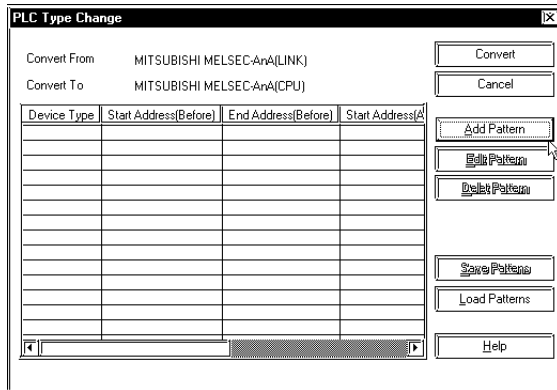

Select the "Address Type" option and designate the available "Start Address" and "End Address" of the PLC before the conversion, as well as the available "Start Address" of the PLC after the conversion, and click on the OK button.

Refer to the list of available devices of your PLC.

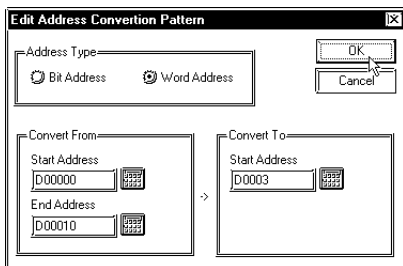

The new conversion pattern is added to the Address Table.

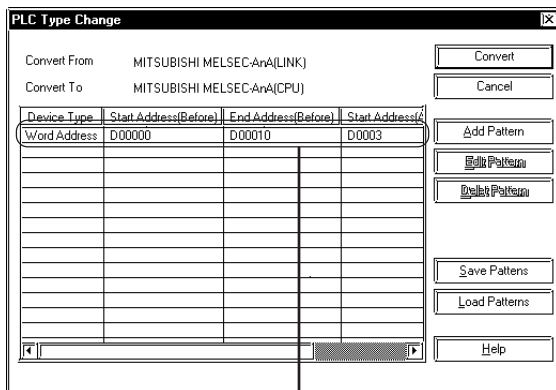

**Added conversion pattern**

PROCEDURE	REMARKS
-----------	---------

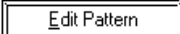
<Editing a conversion pattern>  
 Select the conversion pattern you want to edit from the Address Table and click on the  button.

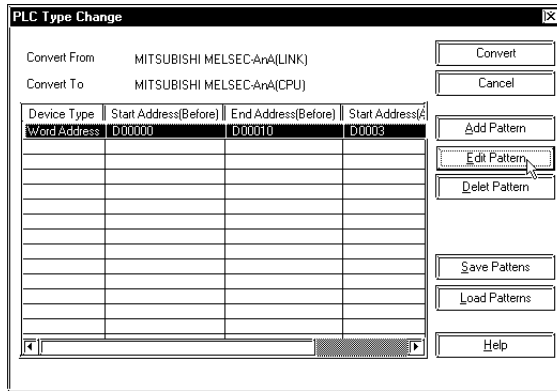

Designate the conversion pattern with the procedure described in Step (4) of [When Device conversion patterns are set].

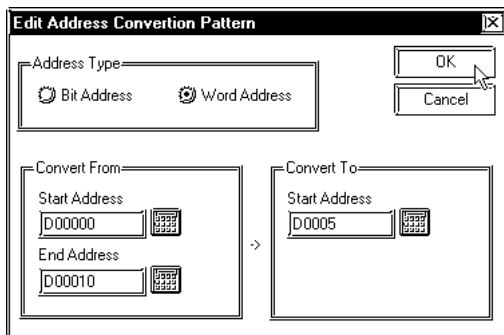

The edited information is displayed in the Address Table of the conversion pattern.

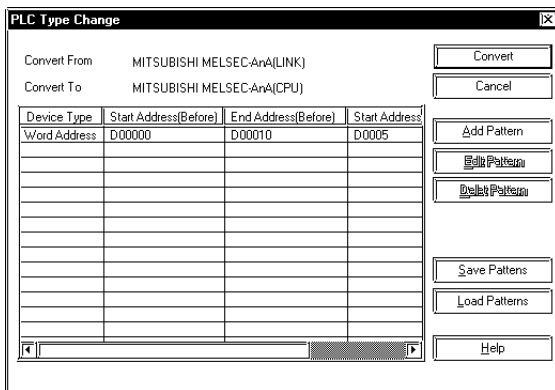

## PROCEDURE

## REMARKS

## &lt;Deleting a conversion pattern&gt;

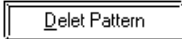
Select the conversion pattern you want to delete from the Address Table and click on the  button.

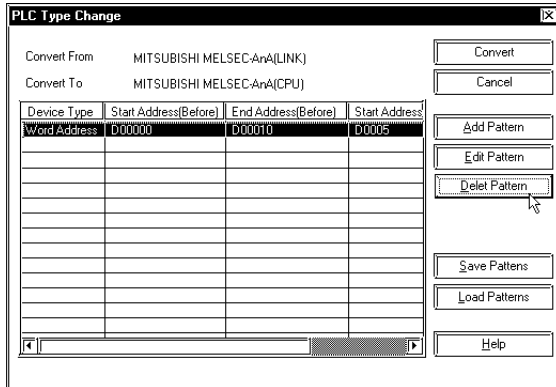

## &lt;Saving a conversion pattern as a CSV file&gt;

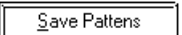
Select the conversion pattern you want to save from the Address Table, and click on the  button.

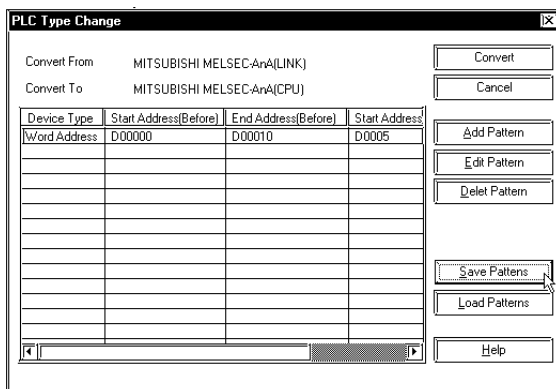
**Designate the file name.**

In the "File name" field, enter the name of the CSV file to which the data will be saved.



Click on the  button to confirm the destination file to which the conversion pattern will be saved.

PROCEDURE	REMARKS
-----------	---------

<Loading a conversion pattern from a CSV file>

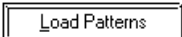
Click on the  button.

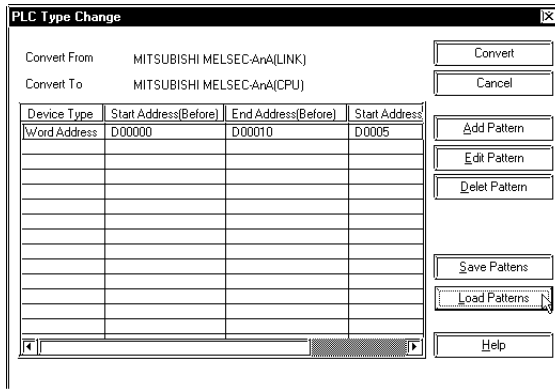

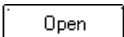
Select the CSV file to be loaded, and click on the  button to confirm the selection.

The content of the CSV file is displayed in the list of conversion patterns.

(6)After setting up the conversion pattern, click the

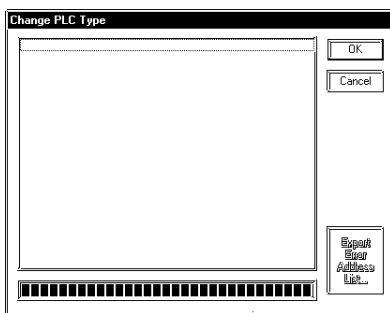
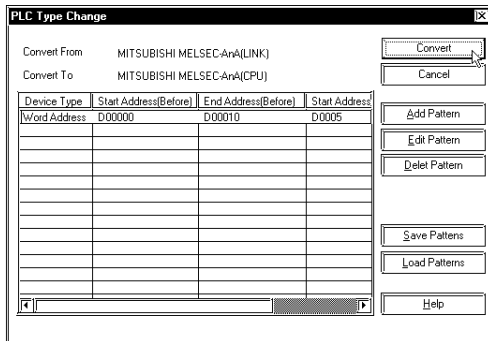

 button to perform address conversion.

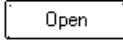

When the combination of the PLCs indicated in "Convert From" and "Convert To" specified in [PLC Type Change] differs from the data on the CSV file, the conversion pattern stored in the CSV file cannot be loaded. Selecting the CSV file and clicking on the  button will not display any data in the Address Table.

Conversion Example (time)  
**[Conditions]** (Contents of project file)  
 No. of screens: 1  
 No. of Tags/Parts placed: 50  
 No. of specified conversion patterns: 10  
**[Conversion time]**  
 About 10 seconds

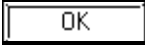
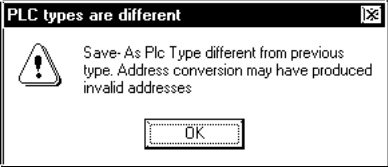
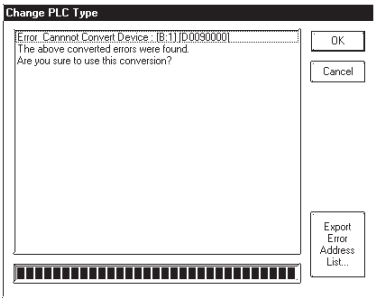
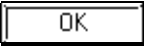
The conversion time increases/decreases in proportion with the number of screens.  
 It may also vary according to changes in the settings of other items.

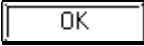
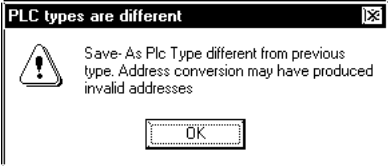
PROCEDURE	REMARKS
<p>[If no conversion error occurs]</p> <p>(7) Click on the  button to exit the setting dialog box.</p>  <p>[If a conversion error occurs]</p> <p>(7) Detailed information on the conversion error is displayed.</p>  <p><b>B screen: Screen No. 0 Device address</b></p> <p>&lt;Completing "Convert Address"&gt;</p> <p>Click on the  button.</p>  <p>Click the  button to exit the dialog box.</p> 	

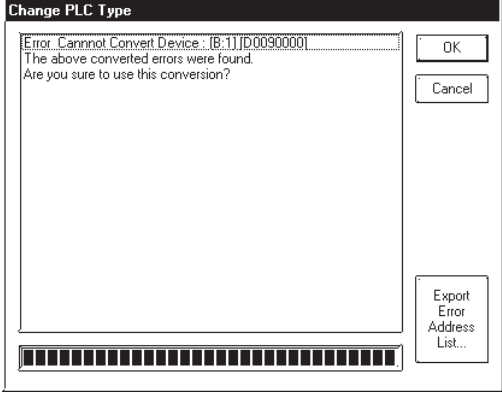
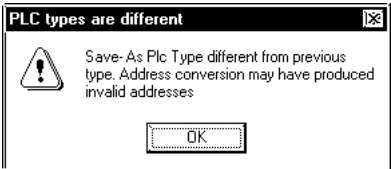

PROCEDURE	REMARKS
<p>&lt;Maintaining a history of conversion errors as text data&gt;  <b>Select the conversion error, and click on the [Export Error Address List] button.</b></p>  <p style="text-align: center;">↓</p> <p><b>Designate the file name.</b>  In the "File name" field, enter the name of the text file to which the data will be saved.</p> <p style="text-align: center;">↓</p> <p><b>Click on the <input type="button" value="Save"/> button to confirm the destination file to which the conversion error will be saved.</b></p> <p style="text-align: center;">↓</p> <p><b>Click the <input type="button" value="OK"/> button to exit the dialog box.</b></p>  <p>&lt;Canceling the PLC and Address Change&gt;  <b>Click on the <input type="button" value="Cancel"/> button.</b></p> <p style="text-align: center;">↓</p> <p>The [PLC Type Change] dialog box appears on the screen and the settings are reset to the conversion pattern settings that existed before the conversion.</p> <p style="text-align: center;">↓</p> <p>Click on the <input type="button" value="Cancel"/> button to close all setting screens for changing the PLC.</p>	

### 4.2.8 Changing Extend SIO Type

You can change the Extend SIO Type selected in the current project.

**Reference** 1.1.2 ■ *Creating a New Project*

This feature is available only with the GP2000 Series.

**Note:** After changing the Extend SIO Type, you can save the current project using [Project] menu - [Save As] command.

**Reference** 1.1.2 ■ *Saving a Project File under a Different Name*

#### ■ Changing the Extend SIO Type

After setting the “Serial I/F Switch”, select the desired “Extend SIO (EXT Serial I/F)”.

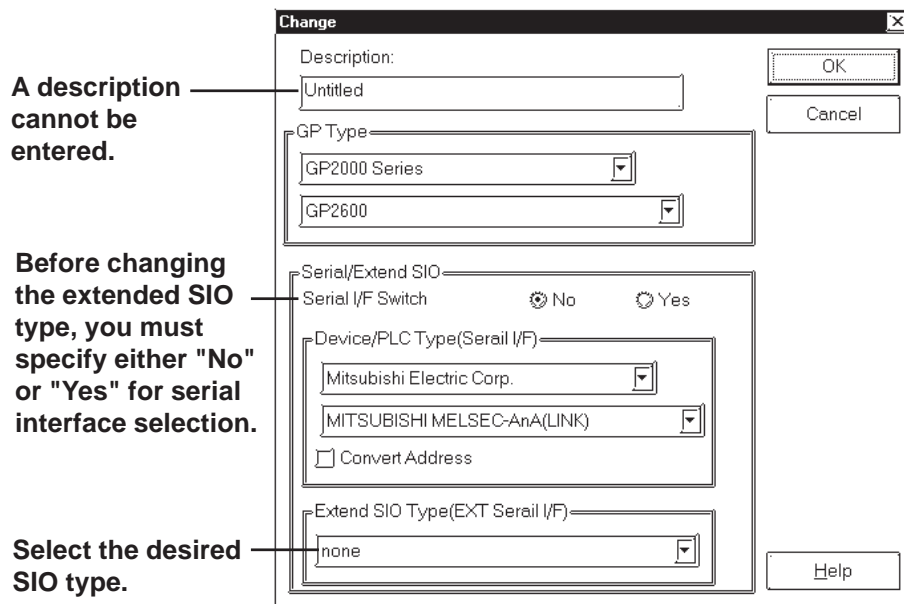

#### ■ Serial I/F Switch



**Important** When changing the [Serial I/F Switch] setting from “No” to “Yes” or vice versa, the following caution message will be displayed. To make the GP unit recognize the Serial I/F Switch, be sure to send the PRW file as well as the [GP Setup (Y)] to the GP unit.

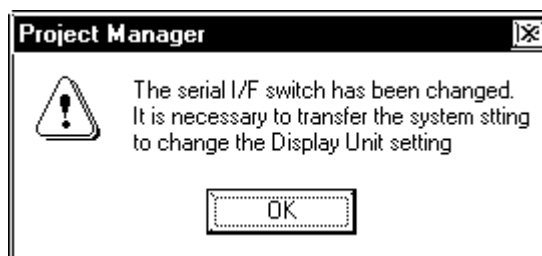

"No" - The Device/PLC connects to and communicates via the GP unit's Serial I/F (COM1). Extend SIO connects to and communicates via the GP unit's Extend Serial I/F (COM2).

- **The default setting for “Serial I/F Switch” is "No".**

“Yes” - The following table shows the unit revision codes that correspond to the “Serial I/F Switch” function.

Series Name	Built-in Standard	Product Name	Unit	Corresponding Revision
GP2000 Series	Serial Interface (Dsub25 Pin)	GP-2300L	GP2300-LG41-24V	All Revisions
		GP-2300S	GP2300-SC41-24V	All Revisions
		GP-2300T	GP2300-TC41-24V	All Revisions
		GP-2400T	GP2400-TC41-24V	Rev.H and later
	Expansion Serial Interface (Dsub9 Pin)	GP-2500L	GP2500-LG41-24V	Rev.B and later
		GP-2500S	GP2500-SC41-24V	Rev.A and later
		GP-2500T	GP2500-TC11	Rev.G and later
			GP2500-TC41-24V	Rev.C and later
	GP-2600T	GP2600-TC11	Rev.F and later	
		GP2600-TC41-24V	Rev.C and later	
	Serial Interface (Dsub25 Pin)	GP-2301HL	GP2301H-LG41-24V	All Revisions
		GP-2301HS	GP2301H-SC41-24V	All Revisions
		GP-2401HT	GP2401H-TC41-24V	All Revisions
		GP-2301L	GP2301-LG41-24V	All Revisions
		GP-2301S	GP2301-SC41-24V	All Revisions
		GP-2301T	GP2301-TC41-24V	All Revisions
		GP-2401T	GP2401-TC41-24V	All Revisions
		GP-2501L	GP2501-LG41-24V	All Revisions
		GP-2501S	GP2501-SC11	Rev.A and later
		GP-2501T	GP2501-TC11	Rev.A and later
GP-2601T	GP2601-TC11	All Revisions		
GLC2000 Series	Serial Interface (Dsub25 Pin)	GLC2300L	GLC2300-LG41-24V	All Revisions
		GLC2300T	GLC2300-TC41-24V	All Revisions
		GLC2400T	GLC2400-TC41-24V	Rev.E and later
	Expansion Serial Interface (Dsub9 Pin)	GLC2500T	GLC2500-TC41-24V	All Revisions
			GLC2500-TC41-200V	
		GLC2600T	GLC2600-TC41-24V	Rev.A and later
		GLC2600-TC41-200V	All Revisions	

**[When the GP2000 Series unit has a built-in Extend Serial I/F]**

The Device/PLC connects to and communicates via the GP's Extend Serial I/F (COM2).The Extend SIO connects to the GP's Serial I/F (COM1). Communication depends on the Extend SIO Script's Protocol.



- Only “Extend SIO Script” can be selected for the “Extend SIO Type (EXT Serial I/F)”.
- When the GP is in OFFLINE mode, "Serial I/F Switch" is automatically set to "No".
- The communication methods available when using Serial I/F (COM1) are RS-232C, RS-422 (4-wire) and RS-422 (2-wire).



**Communication settings:** After "Serial I/F Switch" has been set to "Yes", designate the method via [Extend SIO Settings] dialog box in the [GP Setup | Extended Settings].

When RS-422 (2-wire) is used, an internal 20ms wait is required during communication switching (send/receive).

- The Extend Serial I/F (COM2) is a Dsub 9 pin connector. Refer to the following Signal Wire chart when wiring your cable's connector.

[COM1, COM2 Signal Wire Chart].

Serial Interface (COM1: Dsub25 Pin)		Expansion Serial Interface (COM2:Dsub9 Pin)	
Pin Number	Signal Name	Pin Number	Signal Name
2	SD(Output)	3	SD(Output)
3	RD(Input)	2	RD(Input)
4	RS(Input)	7	RS(Input)
5	CS(Input)	8	CS(Input)
6	DR(Input)	6	DR(Input)
7	SG(-)	5	SG(-)
8	CD(Input)	1	CD(Input)
14	VCC(Output)	9	RI/VCC *1)
17	RI(Input)		(Input/Output)
20	ER(Output)	4	ER(Output)

\*1 COM2's [RI/VCC] can be set using the [GP Setup] dialog box's [Communication Settings] .



When the Serial I/F (COM1, Dsub25P)'s connection cable (GP410-IS00-0 etc.) and a commercial-type conversion adaptor are used for connecting to the Extend Serial I/F (COM2, Dsub9P), the conversion adaptor's COM1(Dsub25P) 's Pin #22 must be connected to COM2 (Dsub9P) 's Pin #9. Also be sure that COM2's [RI/VCC] has been set to "RI" via the [GP Setup | Communication Settings] menu. Setting the [RI/VCC] to "VCC" may cause the RS-232C circuit to malfunction.

Ex.) ARVEL Corporation's RS-232C Conversion Adapter Model: AA830.

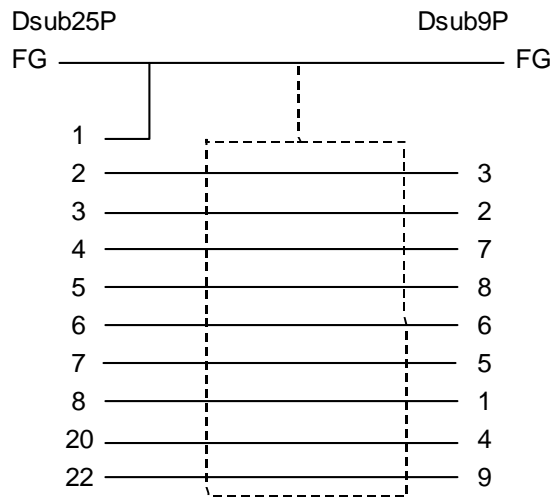



**[When the GP2000 Series unit has only a built-in "Serial I/F (COM1)"]**

Extend SIO connects to the GP unit's Serial I/F (COM1). Communication is performed based on the Extend SIO Script's Protocol.

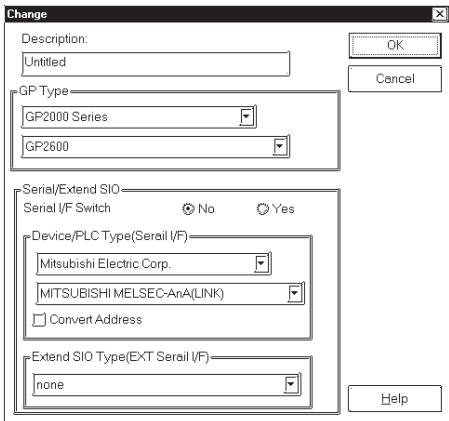
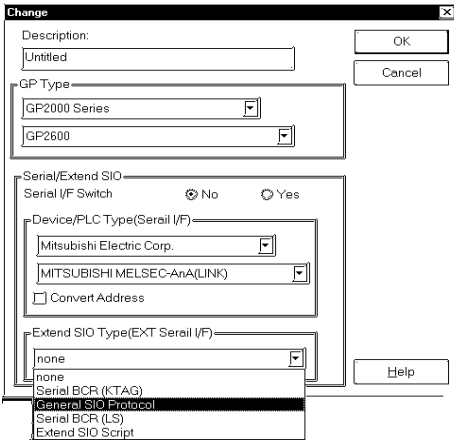

- Only "Extend SIO Script" can be selected for the "Extend SIO Type (EXT Serial I/F)".
- When changing the "Serial I/F Switch" setting from "Yes" to "No", or when changing your project's GP type to a GP2000 series unit (with built-in Extend Serial I/F), be sure to re-select the Device/PLC type.
- When the GP is in OFFLINE mode, "Serial I/F Switch" is automatically set to "No".

PROCEDURE	REMARKS
<p>(1) Via the Project Manager, click on the  icon, or select the [Project] menu - [Change Extend SIO Type] command.</p> 	 <p><b>Important</b> Do not open screens other than the Project Manager. Doing so will disable the selection of the Extend SIO Type.</p>
<p>(2) Select either "No" or "Yes" for serial interface selection.</p> 	<p>The default “Serial I/F Switch” function setting is “No”.</p>
<p>(3) To change the Extend SIO Type, click on the desired Extend SIO type and then.</p> 	<p>When the “Serial I/F Switch” function is set to “Yes”, the “Extend SIO Script” is automatically selected.</p>

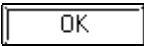
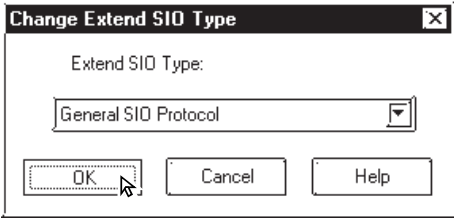
PROCEDURE	REMARKS
<p>(4) Click on the  button.</p> 	

**4.2.9 Protect Setting**

The currently selected project file (.prw) can be fully protected so that a password is required to open or edit the file.

Follow the same procedure for protecting and unprotecting the file.

When a file is protected, you must enter the password each time you open the file.

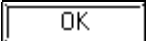
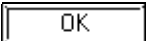

- **Keep a copy of the password in a safe place. If you forget the password, you will be unable to select or edit the project file.**
- **The password is limited to 5 characters. Only alphanumeric data (0 to 9, a to z, A to Z, no symbols) can be used.**
- **When a project file setup for protect is uploaded using GP-PRO/PBIII Ver 6.2 or earlier software, the protect setting will be lost.**

PROCEDURE	REMARKS
<p>[To fully protect a project file]</p> <p>(1) Via the Project Manager (e.g. A PLANT SYSTEM. prw), select the [Project] menu - [Protect Setting] command.</p> <p>(2) Enter a password not exceeding five single-byte alphanumeric characters in both [PassWord Setting] and [PassWord Setting (Confirm)]. Click  .</p> <div data-bbox="213 1323 775 1720" style="border: 1px solid black; padding: 5px;"> <p><b>Protect Setting</b> [X]</p> <p>PassWord Setting <span style="float: right;">OK</span></p> <p>xxxxxx <span style="float: right;">Cancel</span></p> <p>PassWord Setting(Confirm)</p> <p>xxxxxx</p> <p>Warning: Please remember to write down your password! If you forget your password, you never open this project file.</p> </div> <p>[To unprotect a project file]</p> <p>(3) Repeat step (1) above, enter the password, and click  .</p> <div data-bbox="213 1879 679 2072" style="border: 1px solid black; padding: 5px;"> <p><b>Protection Release</b> [X]</p> <p>Protected Version : V6.2 <span style="float: right;">OK</span></p> <p>PassWord <span style="float: right;">Cancel</span></p> <p>xxxxxx</p> </div>	<p>"Protect Version" indicates the version of GP-PRO/PB III for Windows used to protect the file. Protected prw files cannot be opened with a version of GP-PRO/PB III for Windows earlier than GP-PRO/PBIII for Windows Ver 6.2.</p>



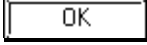
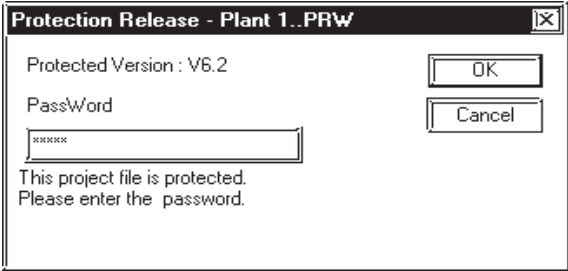

PROCEDURE	REMARKS
<p>[To open a protected prw file]</p> <p>(1) To open a fully protected prw file (e.g. A PLANT SYSTEM.prw), select the [Project   Select] command via the Project Manager.</p> <p>(2) Select "A PLANT SYSTEM.prw" and click on the  button.</p> <p>(3) Enter the password in the dialog box and click on  .</p> 	

## 4.3

## Project Compression/Decompression

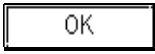
Compressing a project file reduces the size of its data to accommodate a standard floppy disk's limited capacity. A compressed project file and its screens however, cannot be edited. To edit the screens, you must first decompress the project file.

Usage Pattern	
Start	→ Programs → Pro-face → ProPB3 C-Package → 4. Pack Tool →
[Action]	→ [Compress Project File]/ [Decompress Project File] → Designate a Project file to be compressed or decompressed. → Click on the  button.
or	
Click on	 or  .

A general description of the compression tool is as follows:

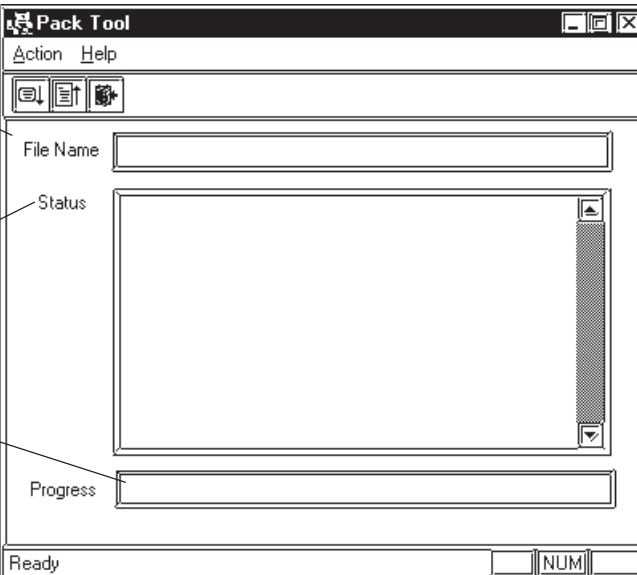

The screenshot shows the 'Pack Tool' window with the following components and annotations:

- File Name:** A text input field for the project file name. Annotation: "Displays the file name of the project to be compressed/ decompressed".
- Status:** A large text area for displaying the status of the project file compression/decompression. Annotation: "Displays the status of the project file compression/decompression".
- Progress:** A progress bar at the bottom of the window. Annotation: "Displays the overall progress of the project file compression/decompression".

The window also features a menu bar with 'Action' and 'Help', a toolbar with three icons, and a status bar at the bottom showing 'Ready' and a 'NUM' indicator.

**4.3.1 Compressing a Project File**

A Project file can be compressed to a smaller size. At this time, a large sized file can be divided into smaller files automatically according to the specified capacity. After a project file is divided into several files during compression, serial numbers are assigned to the first character of each file extension (or assigned to the first and second characters if the file number has two digits).

Example) \*.0PW, \*.1PW...\*.9PW, \*.10W, \*.11W

Enter the file name of the project file to be compressed, or select a desired file name from the list by clicking on the [Browse] button

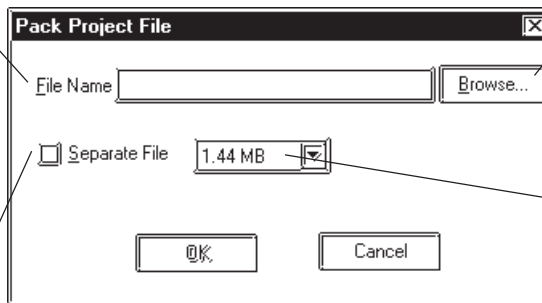

The compressed project file is automatically divided into several files according to the specified file size



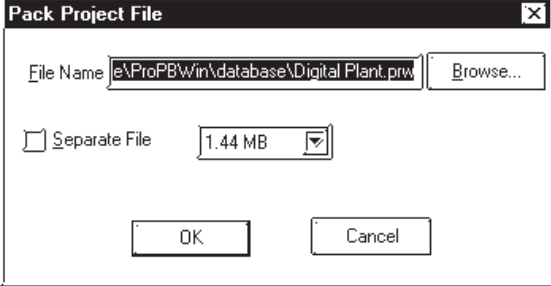
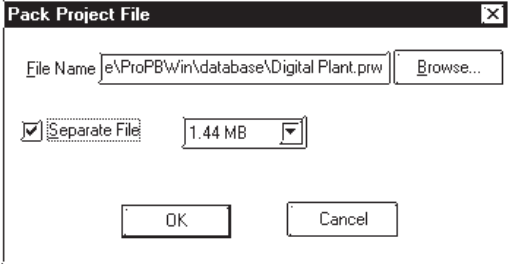

Used to locate the project file to be compressed

Used to select the file size limit

PROCEDURE	REMARKS
<p>(1) First, click the Windows [Start] button. Then, click on the [Programs] - [Pro-face] - [ProPB3 C-Package] menu and click the [4. Pack Tool] menu item. You can also select [Pack Tool...] from the PRO-PB Utility pull-down menu.</p> <div style="display: flex; justify-content: space-around;"> <div style="text-align: center;"> <p>From Windows Main Menu</p> </div> <div style="text-align: center;"> <p>From GP-PRO Program Manager Utility Menu</p> </div> </div> <p style="text-align: center; margin: 10px 0;">↓</p>	

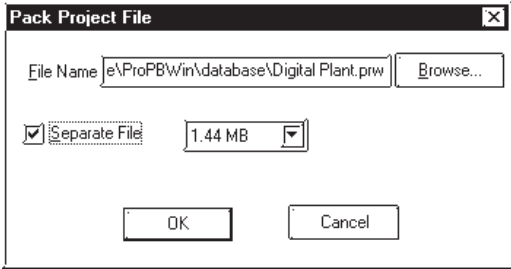
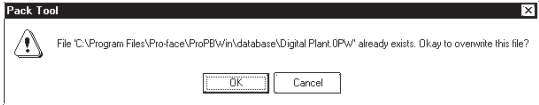
PROCEDURE	REMARKS
<p>(2) Select the [Action] menu - [Compress Project File] command, or click on the  icon.</p> <p>(3) Select the folder and project file to be compressed, or enter the file name. The file name of the desired project file will be displayed in the “Pack” screen.</p>  <p>(4) To divide the project file during compression, click on the [Separate File] check box, and select the desired file size limit.</p> 	<p>To call up a menu of all the available folders, click on the  button.</p>

PROCEDURE	REMARKS
<p>(5) Click on the <input type="button" value="OK"/> button.</p> <p>If the same file name already exists, the system asks if the existing file must be overwritten. If you select <input type="button" value="OK"/>, the existing file will be overwritten. If you select <input type="button" value="Cancel"/>, the existing file will not be overwritten, and you will return to the previous dialog box.</p>  <p style="text-align: center;">↓</p>  <p>(6) Select the [Action] menu - [Exit] command, or click on the  icon.</p>	<p>The compressed project file will be stored in the same folder as the original project file.</p>

**4.3.2 Decompressing a Project File**



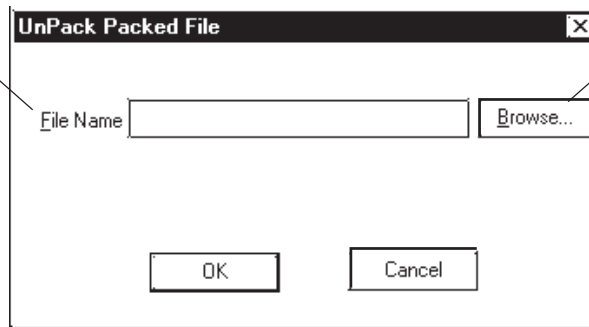

A compressed project file (OPW file) cannot be edited. To edit the compressed project file, you must first decompress it.

Enter the file name of the project file to be decompressed, or select the desired file name from the list by clicking on the [Browse] button

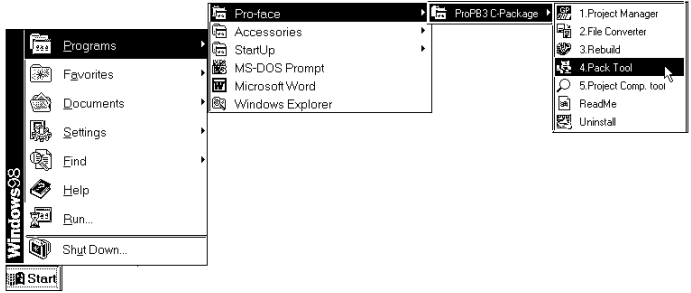
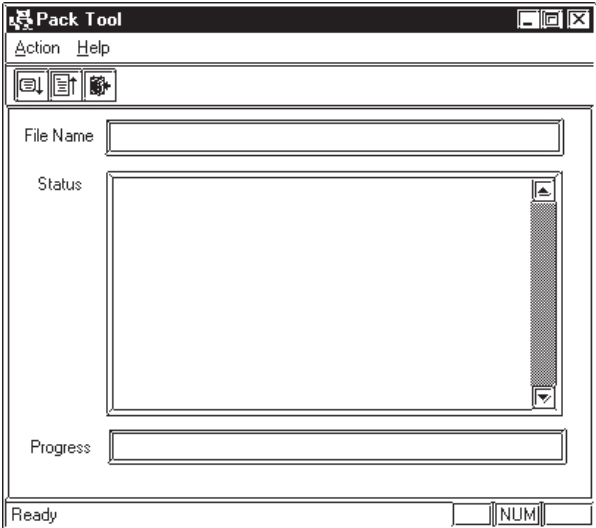

Used to locate the project file to be decompressed

PROCEDURE	REMARKS
<p>(1) Click on the Windows desktop's [Start] button. Then, point to the [Programs] - [Pro-face] - [ProPB3 C-Package] menu and click on the [4. Pack Tool] menu.</p>  <p style="text-align: center;">↓</p> 	

PROCEDURE	REMARKS
<p>(2) Select the [Action] menu-[Decompress Project File] command, or click on the  icon.</p> <p>(3) Select a folder and Project file to be decompressed or enter the file name, and click on the <input type="button" value="OK"/> button.</p> <p>If the same file name already exists, the system asks if the existing file must be overwritten. If you select <input type="button" value="OK"/>, the existing file will be overwritten. If you select <input type="button" value="Cancel"/>, the existing file will not be overwritten, and you will return to the previous dialog box.</p> <div data-bbox="301 734 785 999" style="border: 1px solid black; padding: 5px; margin: 10px 0;"> <p>UnPack Packed File</p> <p>File Name: <input type="text" value="Digital Plant.Opw"/> <input type="button" value="Browse..."/></p> <p><input type="button" value="OK"/> <input type="button" value="Cancel"/></p> </div> <div style="text-align: center; margin: 10px 0;">  </div> <div data-bbox="301 1111 919 1301" style="border: 1px solid black; padding: 5px; margin: 10px 0;"> <p>PBWPack</p> <p> File 'Display Data.PRW' already exists. Okay to overwrite this file?</p> <p><input type="button" value="OK"/> <input type="button" value="Cancel"/></p> </div> <p>(4) Select the [Action] menu - [Exit] command, or click on the  icon.</p>	<p>To select a folder, click on the <input type="button" value="Browse..."/> button.</p> <p><b>To decompress a compressed project file that has been divided into several files, make sure that all divided files are available. However, when you specify the file name to be decompressed, the system displays the first file name (*.0PW) only.</b></p> <p>The decompressed project file will be stored in the same folder as the compressed file.</p>

# 4.4 Comparing Projects

Data can be compared between two project files.

The overview of the Project Comparison Tool is shown below:

Enter project file names to be compared with each other, or select those file names from the list by clicking on [Browse] button.

Select project files to be compared with each other.

Displays the comparison result.

Displays only differences in the comparison result.

Output the comparison result as a text data file.

**Usage Pattern**

Start → Programs → Pro-face → ProPB3 C-Package →

[5. Project Compare] → Specify project → Click on the files to be compared with each other →



PROCEDURE	REMARKS
-----------	---------

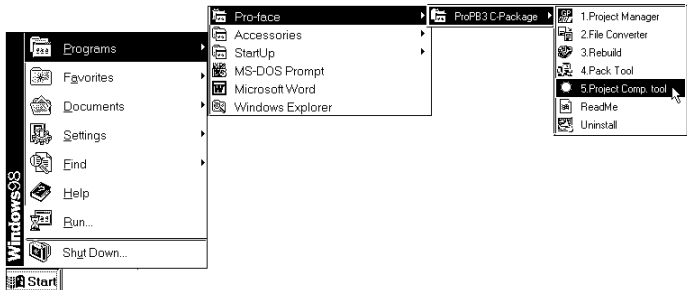

(1) Click on the [Start] button. Move the mouse pointer to [Program], [Pro-face] and then [ProPB3 C-Package]. Click on [5. Project Compare].

The project files to be compared must be prepared using the transfer screen's "Prepare" feature.

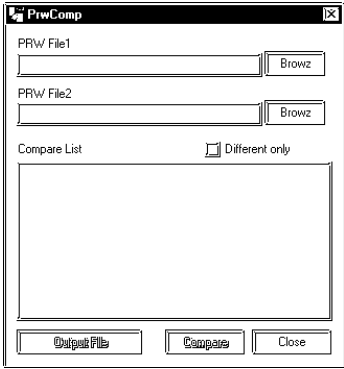
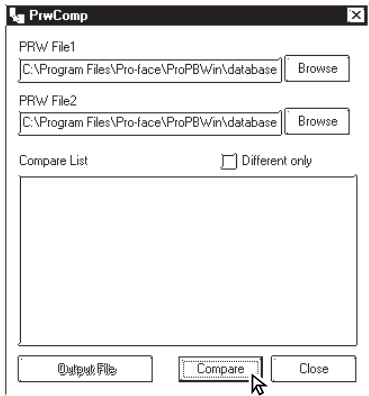

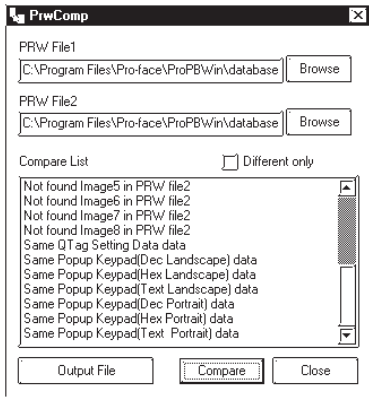

PROCEDURE	REMARKS
<div style="text-align: center; margin-bottom: 10px;">  </div>  <p><b>(2) Select a Project file to be compared or enter the file name, and click on the <span style="border: 1px solid black; padding: 2px;">Compare</span> button.</b></p>  <div style="text-align: center; margin-top: 10px;">  </div> 	<p>Specify folders → <span style="border: 1px solid black; padding: 2px;">Browse</span></p> <p>Checking the [Different only] check box will enable you to toggle between displaying only differences in the comparison result and displaying all the details of the comparison result.</p> <p>Note that a message will appear informing you there is a difference in the GP System settings when the following project files A and B are compared.</p> <ul style="list-style-type: none"> <li>* Project File A stored in the GP-PRO/PB III</li> <li>* Project File B with the following conditions: After the Project File A is transferred to the GP unit, the operation is executed with the data changed with the GP in OFFLINE mode. The settings are returned to the previous settings in OFFLINE mode again, and the screen is received and created via the GPPRO/PB III.</li> </ul> <p>In order to prevent differences in GP system settings between two projects, open project file B using the same GP-PRO/PBIII version that was used for creating project file A. After the file is opened, click the <span style="border: 1px solid black; padding: 2px;">OK</span> button in the [GP Setup] dialog box.</p>

PROCEDURE	REMARKS
<p>(3) Select the [Action] menu - [Exit] command, or click on the  icon.</p>	<p>Comparing project files that were created using different versions of GP-PRO/PBIII will cause a message to appear stating that there are differences in GP system settings.</p> <p>In order to prevent differences in GP system settings between two projects, open the older version project file using the newer project's GP-PRO/PBIII version. After the file is opened, click the  button in the [GP Setup] dialog box.</p> <p>Clicking on the [Output File] button will enable you to output the comparison result as a text file (*.txt).</p>

## 4.5 Information Display

This section describes the types of screen and project information available.

### 4.5.1 Project Information

[Project Information] displays both the commands used to edit the current project, and the date and time of its last revision. To use this command, select the [Project] menu - [Properties] command.

#### ■ Project

#### ◆ Current Project

Displays the file name of the currently selected project file.

#### ◆ Description

Displays a comment about the current project.

#### ◆ Device/PLC Type

Displays the Device/PLC type selected in the currently opened project file.

#### ◆ GP Type

Displays the GP type selected in the current project file.

#### ◆ Extend SIO Type

Displays the current Extend SIO setting. This setting can be changed when a GP2000 series unit is selected as the GP Type. The setting is grayed out when any other type of GP is selected. (Except the GP-2301 and GP-2501)

#### ◆ Project Size

Displays the data volume of the current project file.

If any Parts are placed in this file, the file volume will be increased.

#### ◆ Date & Time

Displays the date and time when this file was saved last.

#### ◆ Size of Screen To Be Sent To GP

Displays the data size that will be occupied by the current project file (the value of the "Project Size") on the GP unit panel. This item indicates the following two conditions separately: the case in which the upload information is sent to the GP unit, and the case in which it is not. The ratio of the current volume of the total screen size to the GP's total memory capacity is displayed as a percentage, serving as the guide for calculating the approximate number of screens that can be created thereafter.

When the data volume is indicated as “????”, select the [Project]’s - [Transfer] menu, and then click the [Prepare] command.

**Reference** 7.2.4 Transfer Preparation



**Note:** The size of the CF card data to be transferred is not displayed.

◆ **Extended Screen Count**

Displays the number of screens that will be created in the GP unit, relative to the current project file. Since this value includes the GP unit’s internal screens, it is larger than the number of screens that have been created with GP-PRO/PB III for Windows 95. To display this information, set up the current project file in the “Transfer Preparation” mode. If the project file is not in the “Transfer Preparation” mode, the number of screens is indicated as “????”



**Note:** The number of screens transferred to the CF card is not be displayed.

◆ **Device Monitor Information**

Displays whether the device monitor command has been registered or not.

■ **Screen**

This screen shows the number of screen types, alarm messages and channels contained in the current project.

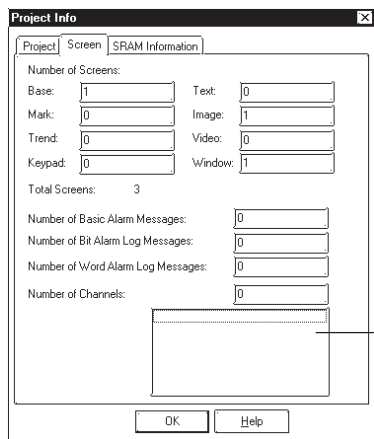

The number of channels and the screen number that are used in the project are displayed

■ **SRAM Information**

The situation with the use of the backup SRAM in the current project is displayed on a function basis.

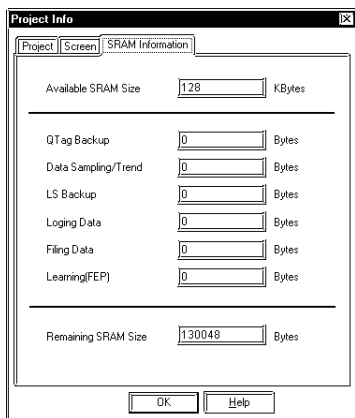

**Note:** If Filing Data is saved on both the GP's internal memory and the CF card, the available capacity of the CF card will be displayed.

## 4.5.2 Screen Information

The [Screen Information] screen displays the settings for the currently open screen, as well as the date and time of its last revision. To use this command, select the [Project] menu's - [Screen Information] command.

### ■ Screen

#### ◆ Project Name

Displays the file name of the currently selected project file.

#### ◆ Device/PLC Type

Displays the Device/PLC type selected in the current project file.

#### ◆ Current Screen

Displays the screen type and screen number of the current screen.

#### ◆ Description

Displays the title of the current screen.

#### ◆ Size

Displays the data volume of the current screen. If any Parts are placed on this screen, the screen data volume will be increased.

### ■ Tag

#### ◆ Used Tags

Displays the number of Tags specified on the current screen.

#### ◆ Available Number of Tags

Displays the acceptable number of Tags after subtracting the number of Tags specified on the current screen from the allowable maximum number of Tags.

◆ **Maximum Number of Tags**

Displays the maximum number of Tags available on the current screen. The allowable maximum number of Tags varies depending on the selected GP type.

GP-270, GP-370, GP-H70 .....	128 Tags
GP-470, GP-570, GP-571, GP-675, GP-870 .....	256 Tags
GP-377, GP-77R, GP2000 series .....	384 Tags

### 4.5.3 Version Information

[Version Information] displays the GP-PRO/PB III Project Manager and Editor's version information. To see this data, select the [Help] menu - [About] command.

#### <Project Manager Version Information>

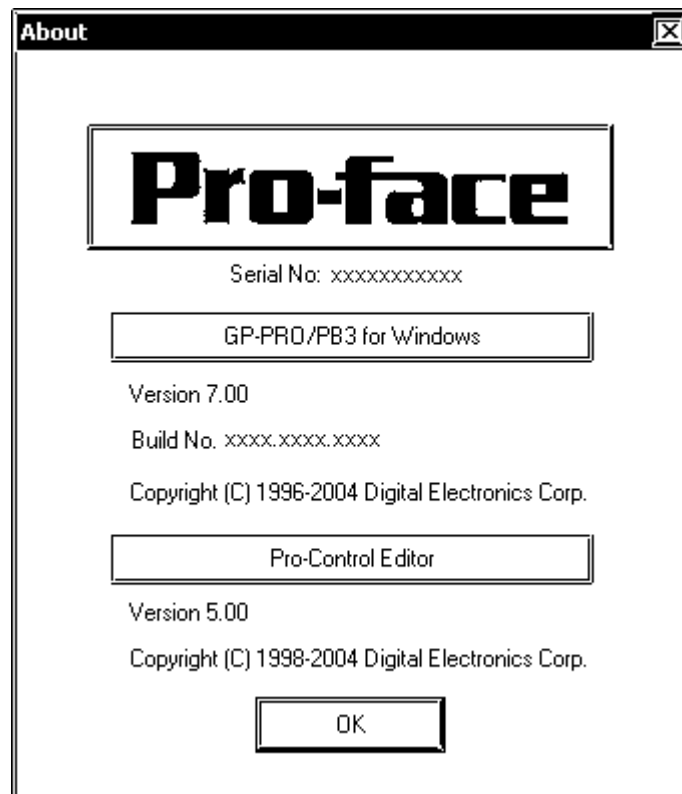

## 4.6 Table Editor Character Strings

The Character Strings Settings and the Multi-language Display Feature are described in this section.



*important*

- **Multi-language Display Feature is supported by GP-377/77R/2000 series units.**
- **Bit map fonts cannot be used in the table editor character strings.**

### 4.6.1 Overview: Multi-language Display Feature

Using Text registered in the Text Table Editor for the text objects and part's labels allow you to easily switch the language and information displayed on the screen during operation (the diagram below describes the steps for switching the display language.) Switching between tables is performed with the Control Address (two or more tables cannot be specified at one time). Thus, you can easily switch the display language or displayed text items on the screen. Character strings are switched by selecting tables (a group of character strings). Registration of the Text and setting the Control Address can be performed with the Text Table Editor.

**Example: Switching the display language for the label of a part**

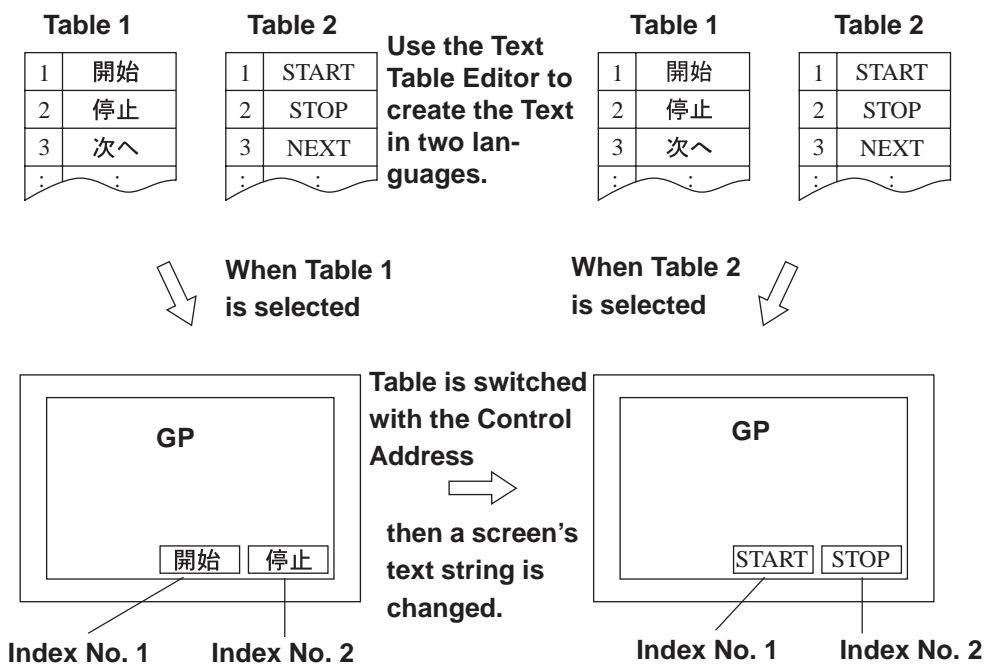



- **Switching tables uses the same process as switching screens. Therefore, some screen displays drawn with tags may not be able to be refreshed.**
- **The following character strings cannot be changed even when the tables are switched.**
  - [A-tag] character strings
  - [K-tag] character strings
  - [S-tag] character strings
  - [P-tag] format character strings
  - [X-tag] character strings
  - Filing Feature
  - Logging Feature

◆ **Precautions for switching tables with the Alarm function**

- When a table is switched while an alarm message (Flow display) is displayed, the switched table is not used until the next message is issued.

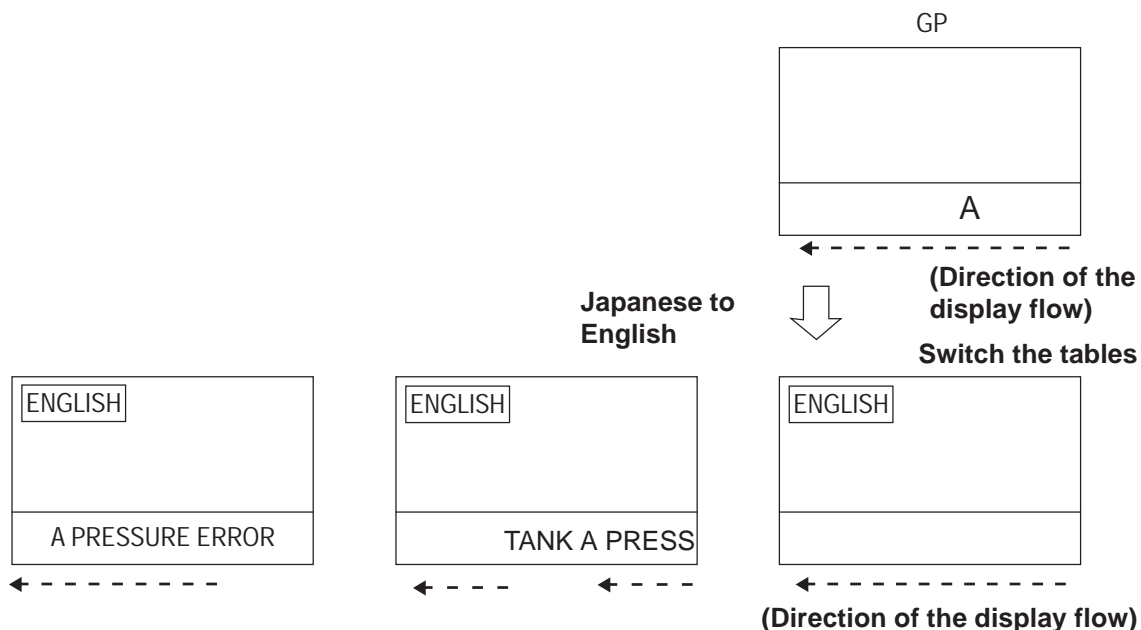

- When the print setting is enabled for the Alarm Message Function (Flow display), the alarm message of the table (language) displayed at the moment when the alarm is triggered or reset will print.
- When a table is switched while real-time printing is set to print the alarm summary (a-tag) or log alarms (Q-tags), the switched table will be used starting from the next print job.





- When a table is switched while log alarms (Q-tags) are being written into the CF Card as a CSV file, the switched table is used immediately.
- The steps for switching tables are similar to those for switching screens. Therefore, the Sub Display, Cursor Display and Scroll Display that were displayed before the switching with the Log Alarm (Q-tag) will not be reproduced.

### 4.6.2 Table Editor Character Strings

The Table Editor is used to create a table's character strings.

Table Editor Character Strings can be exported in CSV format. You can also import a CSV file to use as a table editor character string.

Operation procedures	
<b>Start</b> → [Screen/Setup] → [Text Table...]	→ [Put a check mark in the "Text Table(ON/OFF)" checkbox.] →
Assign Control Address.	→ Select font from [Font Setting] menu. →
Enter character string.	→ Save table data.

#### ■ Table Editor Features

Put a check mark here to enter the mode in which Text Table Editor is enabled.

Click here to specify the Control Address

Select a table to enter character strings. Up to 16 tables can be registered

Index No. Up to 3,000 character strings can be registered



After setting up the text, specify the line and click the [Go to] button to jump to the specified line.

Set the font (language) for the selected table

Double-click on this area to call up a message dialog box (Up to 1,200 characters)

Index No.	Charac...	Lines	Message
1	10	1	
2	10	1	
3	10	1	
4	10	1	
5	10	1	
6	10	1	
7	10	1	
8	10	1	
9	10	1	
10	10	1	
11	10	1	
12	10	1	
13	10	1	
14	10	1	
15	10	1	
16	10	1	
17	10	1	
18	10	1	
19	10	1	
20	10	1	
21	10	1	
22	10	1	
23	10	1	
24	10	1	

■ Using the Text Table Editor

- When a check mark is placed in the "Text Table(ON/OFF)" checkbox (ON mode), the Table Editor is switched to input mode, enabling additional settings such as Table setting and Index Text registration.
- When the check mark is removed from the checkbox (OFF mode), the following warning message dialog box appears. Clicking the  button deletes all Text Table data registered in the project. Click the  button to retain the data.

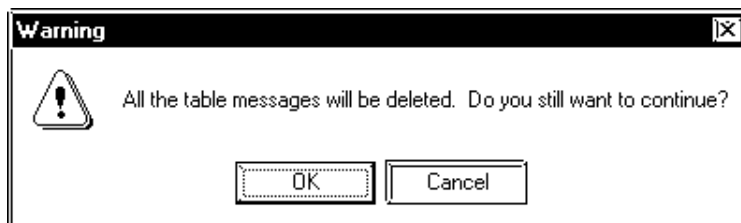

■ Entering ControlAddress Settings

Specify the Control Address to switch the tables.

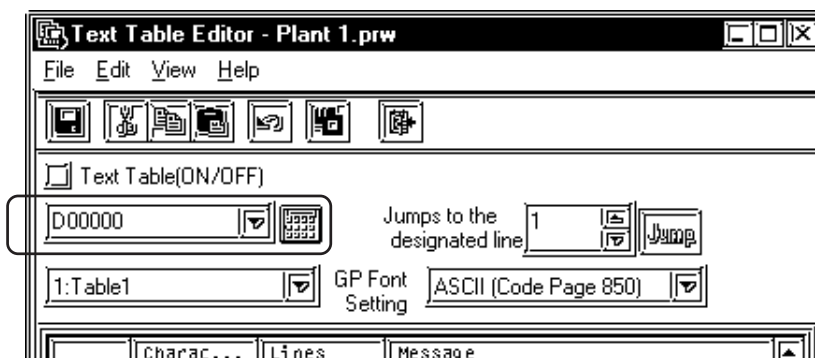

In the Control Address, store the Table No. you want to display. The default text table is displayed when "0" is stored. To set up the default text table, select [Default Table Setup] from the [File] menu on the "Text Table Editor" dialog screen.

<Values stored in the Word Address>

Value in one Control Address	Table No.
0	Initial character string table
1	Table 1
2	Table 2
:	:
16	Table 16



- A table will not appear when you specify a table number for which nothing is set.

### ■ Table Name

Up to 16 tables can be registered.

To change a table name, display the table whose name is to be changed onto the "Text Table Editor" screen. Next, click [Table Name Change] on the [File] menu.

Enter the desired table name and click the [OK] button to change the table name.

### ■ GP Font Settings

Specify one font (language) for each table (a table cannot contain more than one font [language]).

### ■ Entering Messages

On the Text Table Editor, double-click the column of the Index No. you want to set up. The screen below appears on the screen. Enter the Text for each Index Number.

Specify the message size [Characters] x [Lines] for each Index No.

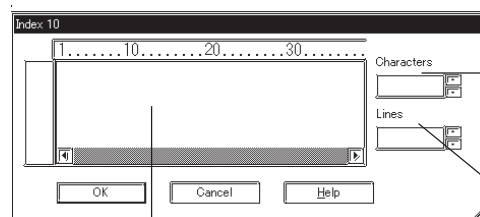

Character Entry Area

Specify the number of characters in a line. (1 to 100 single-byte characters)

Specify the number of lines. (1 to 40 lines)



**Note:** • The number of characters used in a table editor character string is determined by [Characters] x [Lines]. (Max. 1,200)

$$[\text{Characters}] \times [\text{Lines}] \leq 1,200$$



- Multiple display lines can be used for [Character string] and Parts [Label] only. For other features, do not specify an index number for which multiple display lines are set. If such an index number is specified, only the first line will be displayed.





Important

**The table editor characters for each index number [Characters] x [Lines] are available in all tables.**

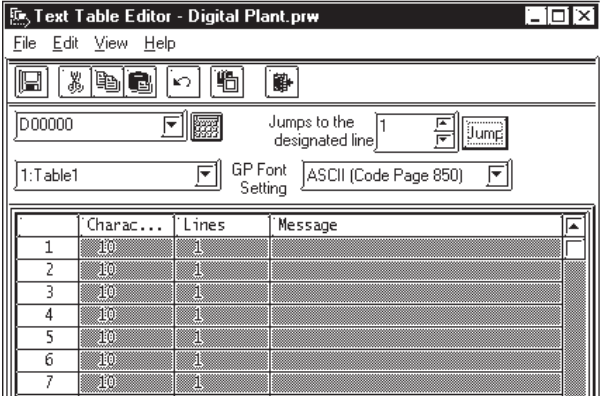
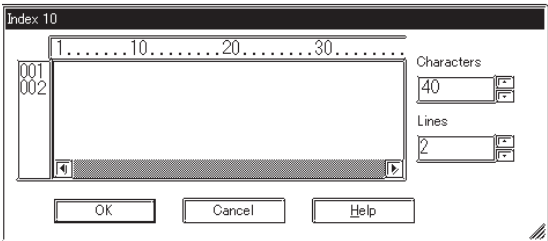
■ Table Editor Character String Registration

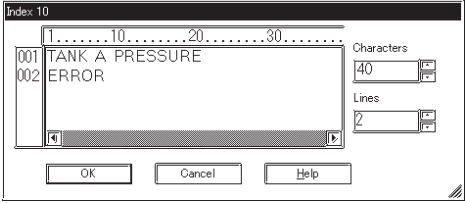
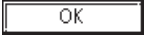
PROCEDURE	REMARKS
<p>(1) In the Project Manager, select the [Screen/Setup] menu - [Text Table...] command.</p> <p>(2) Put a check mark in the "Text Table Editor" checkbox in the [Text Table(ON/OFF)] dialog box.</p> <p>(3) Click on the  icon and enter the [Control Address].</p> <p>(4) Select a font from the [Font Setting] menu .                      Select a table from  on the right of the "Table 1" field and select a font (language) from  on the right of the "GP Font Settings" field.</p> <p>(5) Double-click the table editor character string entry area.</p> 	<p>The table name can be modified by selecting [File] menu - [Table Name Change].</p> <p>You can choose from the following five selections.</p> <ul style="list-style-type: none"> <li>• ASCII (Code Page 850)</li> <li>• CHINA (GB2312)</li> <li>• JAPAN(JIS)</li> <li>• KOREA (KS-C5601)</li> <li>• TAIWAN (Big5)</li> </ul>
<p>(6) Enter the desired [Characters] and [Lines] according to the table editor character string.</p> 	<p>The number of characters used in the table editor character string is determined by [Characters] x [Lines]. (Max. 1,200)  <math>[Characters] \times [Lines] \leq 1,200</math></p> <p>Multiple display lines can be used for [Character string] and Parts [Label] only. For other features, do not specify an index number for which multiple display lines are set. If such an index number is specified, only the first line will be displayed.</p>

PROCEDURE	REMARKS
<p>(7) Enter the table editor character string.</p>  <p>(8) Click the  button to confirm the characters.</p> <p>(9) Repeat the same steps to set the index character strings for the other index numbers.</p> <p>(10) Repeat the same steps to create other tables.</p> <p>(11) Select the [File] menu - [Save] command or click on the  icon to save the setting.</p>	<p>Up to 16 tables can be registered.</p>

### ■ Importing/Exporting CSV files

You can export the contents of a table created using the Table Editor as a CSV file, or you can import a CSV file created using another table editor software into the Table Editor.



- **To edit data exported into a CSV file, or edit data that has been previously exported, use an operating system that supports the font specified in [GP font setting] of Table Editor Character Strings.**

#### ◆ Importing CSV files

Select the [File] menu - [Import] command.  
Use the following dialog box to select the desired file.

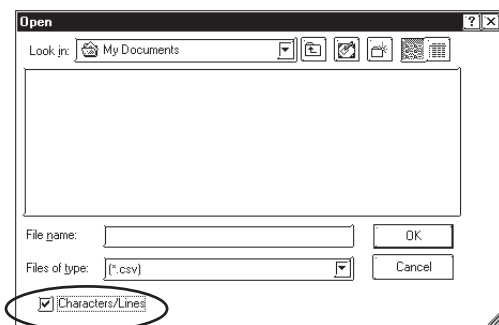

- **When a CSV file is imported, the existing table editor character string is overwritten.**
- **When [Characters/Lines] is selected**  
*If the imported [Characters] x [Lines] of the CSV file setting values are lower/less than the table editor character string values set in the [Table Editor], any excess/remaining characters in the [Table Editor] will be deleted during import.*
- **When [Characters/Lines] is not selected**  
*If the imported CSV file's setting values are higher/greater than the table editor character string values set in the [Table Editor], any excess characters in the imported data will be deleted during import.*
- **When a table is imported from a CSV file, if the [Characters/Lines] value of each index number of a table to be imported is less than the [Characters/Lines] value of the index number existing in the [Table Editor], the table will be imported with the [Characters/Lines] value set in the [Table Editor].**
- **Do not import a CSV file if the [Characters/Lines] value exceeds 1200. It will not be correctly imported.**
- **If you import the Text Table after changing "Characters" or "Lines" on the Text Table Editor, please check the label on which the text is used before saving data.**

#### ◆ CSV file format for character string tables

CSV file format

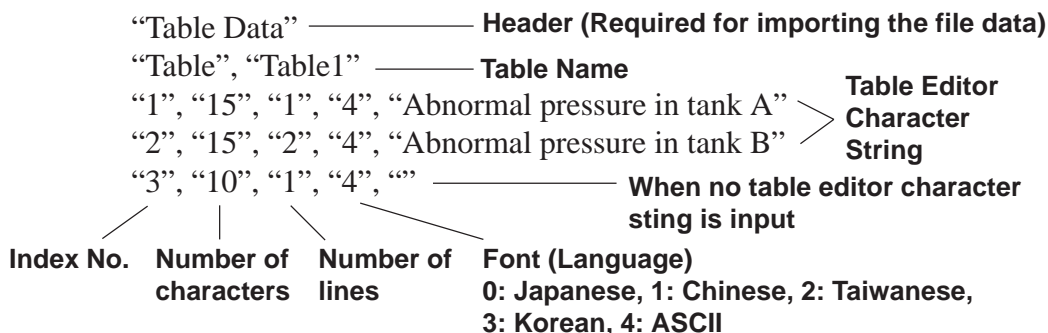

**4.6.3 Entering Settings via the Screen Editor**

**■ Selecting the Drawing Table**

From the menu bar in the Screen Editor, select the table to use for drawing. When a table is changed, the character strings used in the Screen Editor also change.

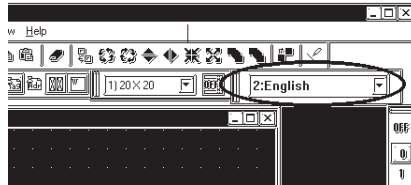

*important*

- *In each dialog box of the text objects, part's labels or Alarm text, if [Browse Text Table] is selected and [6x10],[8x13] or [13x23] is selected for Font Size(TCP Font is selected), the characters displayed on the screen for drawing may be garbled.They are displayed on the GP properly.*

**■ Selecting the table editor character string**

**◆ Entering the table editor character string**

Click on the [Browse Text Table] to switch the screen to the one used to enter the table editor character string.

Select the desired table editor character string from those shown in the [Table Editor]. To add a new table editor character string, click the

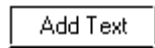

button to start the [Table Editor].

**▼ Reference 4.6.2 Table Editor Character Strings ■ Table Editor Character String Registration**

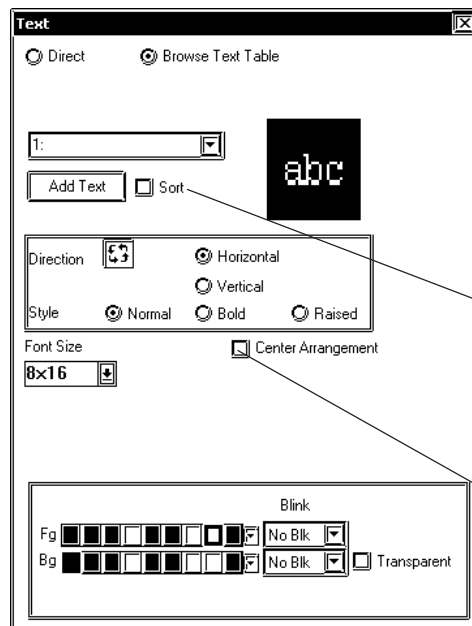

Place a check mark here to sort the table editor character strings displayed in the pull-down menu in character code order. (Discriminates between single-byte and double-byte characters.)

When enabled, the text's text box is centered within the designated "frame".



- The size of any text object placed on the drawing area automatically changes according to the size specified in the Table Editor ([Characters] x [Lines]). Switching tables does not change the text size.
- [Centering Arrangement] feature's initial setting is disabled (not selected). If this feature is left unselected and the Text dialog box settings are:

No. of Table Editor Characters : 15

No. of Rows : 3

the following alignment settings will produce the following results.  
(the Text's "position" is displayed separately)

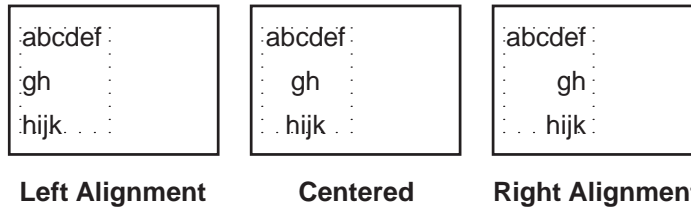

The "frame/border" shown around the text registered in the Text Table Editor is created according to the character and row specifications given above. Even though the dotted border is not shown on the screen, it conforms to the number of characters and rows specified.

When the [Centering Arrangement] feature is enabled (selected), the text's frame/border (the dotted one) is centered relative to the lines/border of the black rectangle.

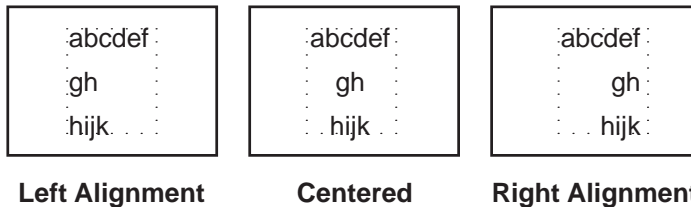

This feature is used in the same way in the Message Display Part's [General Settings] tab.

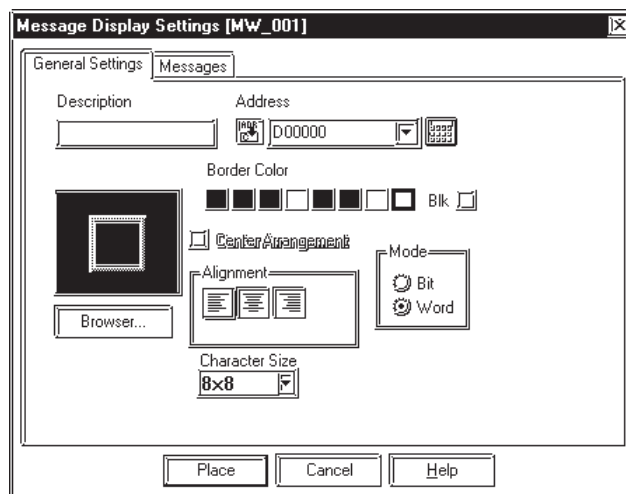



◆ Designating Part Labels

Select [Browse Text Table] in the Part's [Label] area to change to the table editor character string entry screen.

Select the desired [Browse Text Table] from those specified in the [Table Editor]. To add a new [text], click the **Add Text** button to start the [Table Editor].

▼ **Reference** 4.6.2 Table Editor Character Strings ■ Table Editor Character String Registration

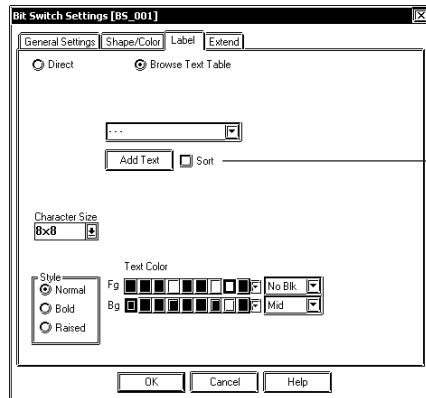

Place a check mark here to sort the table editor character strings displayed in the pull-down menu in character code order. (Discriminates between single-byte and double-byte characters.)



**Note:** The size of any text placed on the drawing area automatically changes according to the size specified in the Table Editor ([Characters] x [Lines]). Switching tables does not change the text size.

◆ Designating Message Display Messages

In the Message Display Settings, select the "Browse Text Table" option in the [Messages] area.

Select the desired table editor character strings (Index No.) from those specified in the Table Editor. To add new table editor character strings, click on the **Add Text** button to activate the Table Editor.

▼ **Reference** 4.6.2 Table Editor Character Strings ■ Table Editor Character String Registration

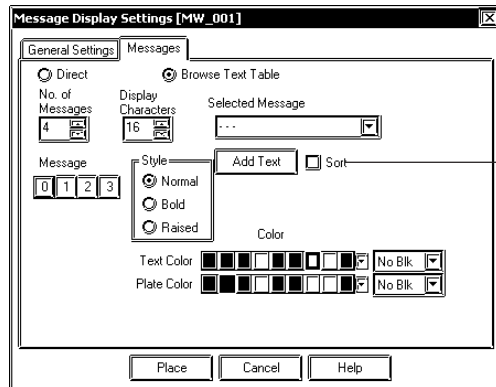

Place a check mark here to sort the table editor character strings displayed in the pull-down menu in character code order. (Discriminates between single-byte and double-byte characters.)



**Note:** The frame size of the Part will be displayed according to the table editor character string (Number of characters x Number of lines) of the specified Index No. The frame size of a Part remains the same even if the Table is switched.

### ◆ Selecting Alarm Editor Messages

First, select [Text Method] in [Alarm] in the [Alarm Editor] and change the character string setting mode to [Browse Text Table].

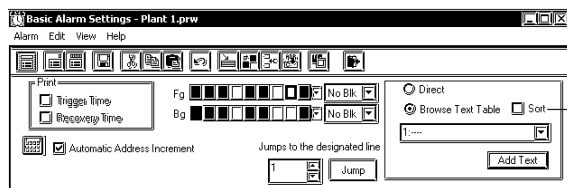

Place a check mark here to sort the character strings in character code order. (Discriminates between single-byte and double-byte characters are discriminated.)



**When the character string setting mode is changed, all previously registered alarm messages are deleted.**

Then, click  in [Message/Summary Text] to view the list of [Character strings] specified in the [Table Editor]. Select the desired Text from the Texts registered on the Text Table Editor.

If you want to add new [text], click the  button to start the [Table Editor]. **Reference** 4.6.2 Table Editor Character Strings

#### ■ Table Editor Character String Registration

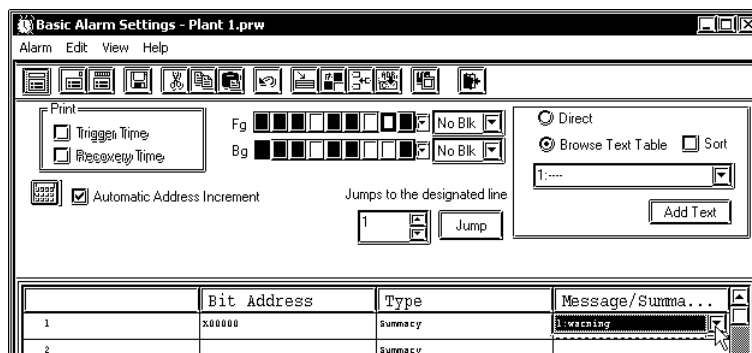

[Character strings] can also be selected by choosing [Add Alarm(s)] in [Edit].

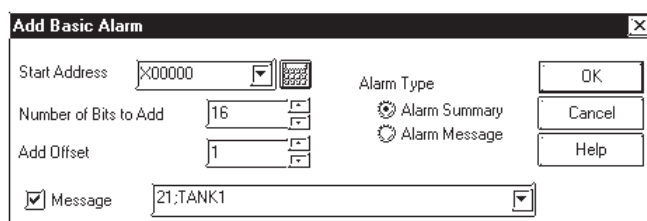

- **When messages are registered with the Alarm Editor, Direct Text and Text registered in the Text Table Editor cannot be mixed.**
- **Do not set up a Text registered in the Text Table Editor with two or more lines. Only the first line will be displayed, even if two or more lines have been set up.**

### 4.6.4 Text Table Converter

This feature allows you to easily batch convert, attach Index numbers to and register Text table text strings used for directly designated Part and Screen item text labels.

All of a Project's screen and Part labels, as well as Alarm direct text can be batch converted. Instead of all of a Project's direct text, conversions can be performed according to a pre-defined range of text.

Operation procedures	
[Utility] → [Text Table Converter] →	Select Project File to be Converted →
→ Select the Screen range, Converted Text and Converted Table No.	Click on <input type="button" value="Conversion"/> to start or Click on <input type="button" value="Close"/> to cancel

The features of the Text Table Converter are as follows:

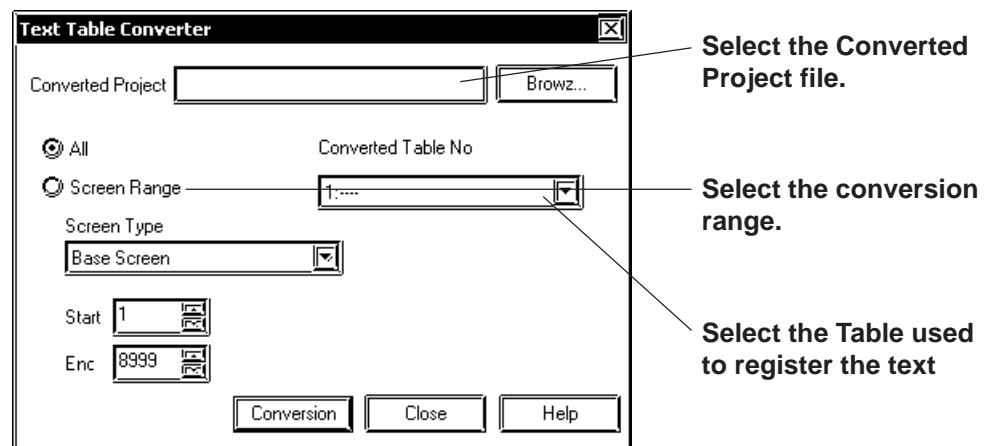

#### ◆ Converted Project

Select the destination project file used for the text converted from the current project file.

#### ◆ Conversion Range

- All  
Converts all of a project's directly designated text to table text, including Screen, Part and Alarm text.
- Screen Range  
Choose from a range of Base (B, Trend Graph (T), Keypad (K), text (T), Window (W), alarm Message/ Alarm Summary, Bit Log Alarm, and Word Log Alarms. Only when specifying a range do you need to enter the start and end screen numbers.

**◆ Converted Table Number**

Designates the text table number of the text table used to store the converted text and index numbers.

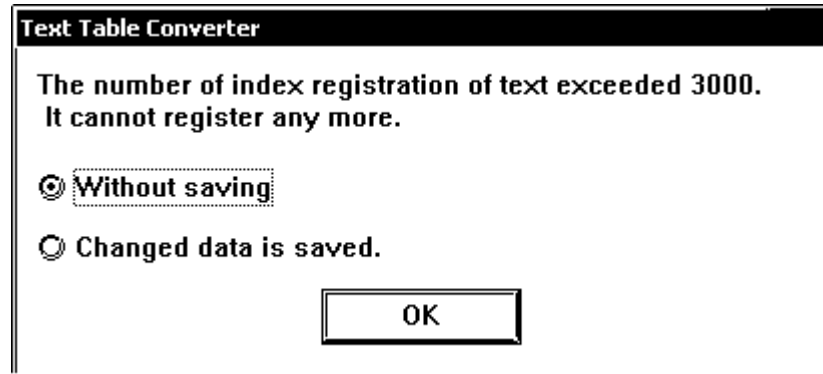

**Note:**

- In a single table the maximum number of index numbers is 3,000. If the converted texts exceed 3,000, the following dialog box will appear. To save only the data within this range, select [Save all currently converted data]. To not save any of the converted data, select [Quit without saving] and click OK.

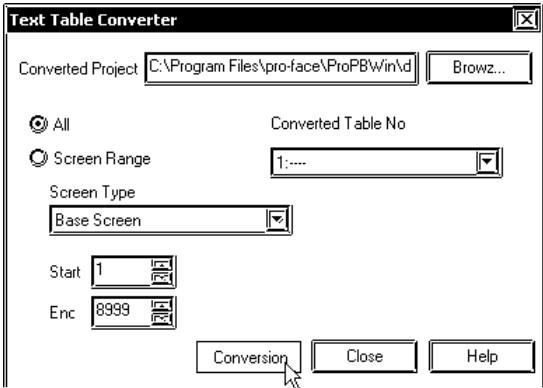
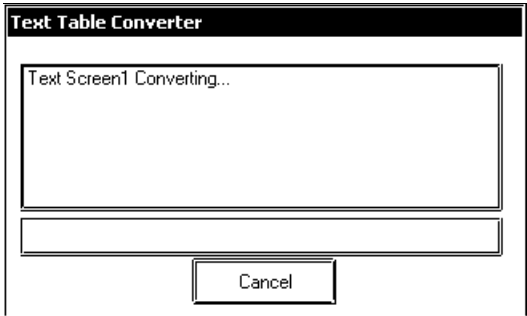

- If the converted project file and the original project file contain the same text data, conversion will not create an index number for that text. The destination file's index number will simply contain a substitute number and message.
- If the [Text Table Converter] feature is performed, screen data as well as text registration will be converted to the original project file. To be prepared for unintended performance results, it's recommended that you save the converted project file as a different name before performing the [Text Table Converter] feature.

■ Converting Project Files to Text Tables

PROCEDURE	REMARKS
<p>(1) Select the Project Manager Utility menu's [Text Table Converter].</p> <p>(2) Designate the [Converted Project]'s project file. Use the [Browse] feature to find the desired file.</p> <p>(3) After setting the screen range and the Converted Table No, click on [Conversion]. To cancel the settings, click [Close].</p> 	
<p>(4) Conversion is performed. To stop the conversion, click [Cancel].</p> 	
<p>(5) After the conversion is completed, the following dialog box will appear. click [OK] to close the window and return to the Text Table Converter.</p> 	

## 4.7 Security Feature

Security levels can now be assigned to individual Base or Window screens, based on the User-designated settings. The following explanation describes the settings used for the security and password features.



• **The security feature is available only with GP2000 Series units.**

### 4.7.1 Overview

Security levels can now be assigned to individual Base or Window screens. For example, if the new screen's security level is higher than that of the current screen, you will need to enter a password in order to change to the new screen.

In the following diagram, entering the correct password allows access to screens with a security level of 5 or lower, without having to reenter a password. (Security Level Status: Level 5)

When changing from the current security level status to a screen that has either the same or a lower security level, no password entry is required. This type of easy-to-use password-based screen data control allows you to guarantee the safety of your important project data.

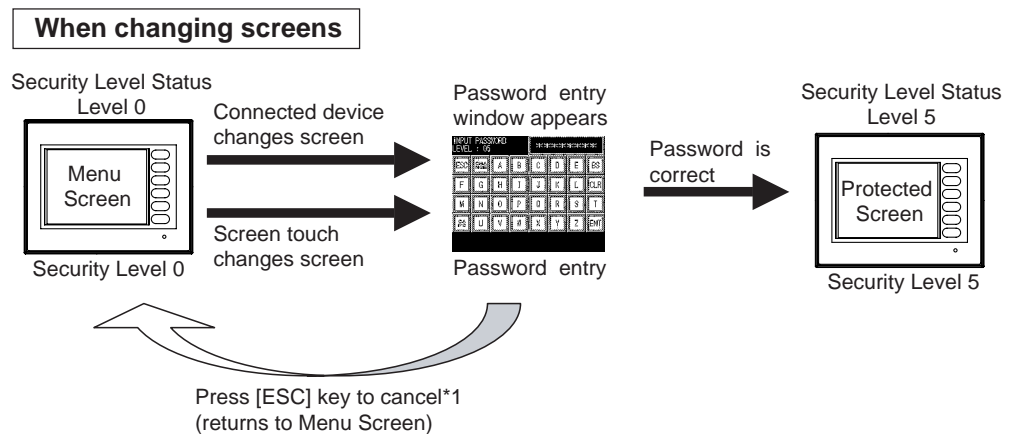

\*1 When canceling the screen change from a Device/PLC, use the Password Cancel Alert Bit, and return to the original (above: Menu screen) using the Device/PLC. For information regarding the Password Cancel Alert Bit, **Reference** 4.7.2 Password Settings ◆ Notification Bit of Password Cancel

Even in the cases shown below, if the new screen to be changed to has a higher level of security, you must enter the correct password in order to view the new screen.

- Displaying a window registered on a Base (B) screen, Window (U) screen (when using a U-tag<sup>\*1,\*2\*3</sup>, a Window Part<sup>\*3</sup>, or a Global Window<sup>\*3</sup>)
- Changing to an Alarm screen's sub-screen (A-tag, Q-tag)
- Device/PLC control request for a screen change.
- Screen change using a Function Switch.
- Forced reset (Using either 3-point touch on the unit's display) /Touch upper left corner of screen within 10 seconds of power ON or a Function Switch to change to an OFFLINE screen.
- Initial Base Screen display.<sup>\*4</sup>

---

\*1 Be sure not to use the U-tag's [High Speed] feature in the [Designated Window] tab, since it may not operate correctly.

\*2 The security level for a window that is registered on a Base (B) screen comes from the base screen where the window is registered.

\*3 When you cancel password entry for a Window (U) screen, the control address used for the window's U-tag, Window Part, or Global Window display, is automatically cleared. Also, the indirectly designated window number and display position are also automatically cleared.

\*4 The correct password MUST be entered. This screen cannot be cancelled using [ESC] key.

◆ Security Levels

- A total of 16 settings are available - 0 to 15. "0" designates that no security is set for a given screen. Levels 1 to 15 designate the level of security, from low to high, with 15 being the highest level. For level setting information, **Reference** 4.7.2 Password Settings
- Security level settings for a Base (B), Window (U) screen can be set when the screen is saved, or when that screen's name is changed. (See below)

When changing the security levels of the multiple screens at the same time, use the [Security Level List] dialog box.

For usage details, **Reference** 4.7.3 Security Level List

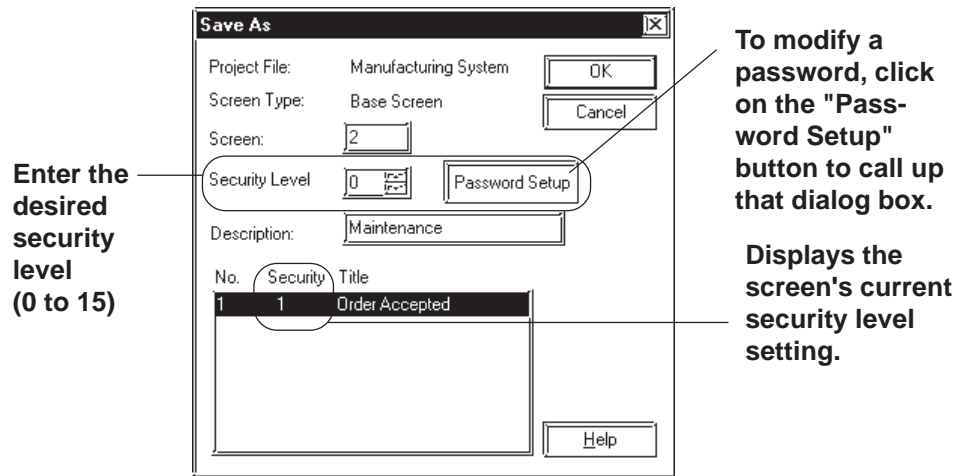

<When saving a screen and assigning a name>



- Be sure to check/select the [Password Settings] screen's [Use Security level] setting. If this setting is not checked, this screen's security feature is disabled/displayed.



- **The initial security level setting for all Base (B) and Window (U) screens is "0".**  
**The initial security level setting for all Base (B) and Window (U) screens of projects created using versions of GP-PRO/PBIII for Windows Ver. 6.2 or earlier is "0"**
- **If a project created using this Security feature is saved using Ver. 6.2 or earlier, all security level settings will be reset to "0".**



## 4.7.2 Password Settings

This screen allows you to set a screen's security level and password.

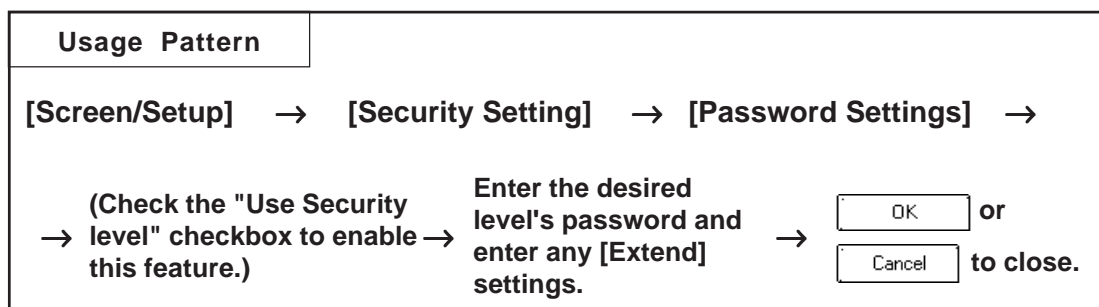

### ■ Password Setting

**Enables/Disables the security feature.**

**Password must be 1 to 8 single-byte characters. (If both upper-case and lower-case characters are used, the password must be entered using the exact same case characters.)**

**Selecting this will require the entry of the Level 15 password when switching to OFFLINE mode.**

**Note:** • Password entry for screen security can only be performed via the [Password Setting] dialog box.

#### ◆ Use Security level

Clicking/selecting this feature enables the security level(s) in the project.

#### ◆ Security Level and Password

A total of 16 settings are available - 0 to 15. "0" designates that no security is set for a given screen. Levels 1 to 15 designate the level of security, from low to high, with 15 being the highest level. Only the required levels need to be set passwords. All the levels do not need to be set the passwords.

**Note:**

- The same password cannot be used on more than one level.
- Spaces and symbols cannot be used.
- A password cannot contain all blank spaces.

◆ **Specify Password Level 15 when switching to offline**

When you change screens in OFFLINE mode, the password entry window will appear on the GP display and request the security level 15 password. When you change back to online mode, the security status level will change back to "0", indicating no password is required.

If you choose [System Settings] from the [GP Setup] dialog box and enter a [Common Password] that is used when switching between OFFLINE and online modes, after entering the Level 15 password, this common password's entry screen will appear. (See below)

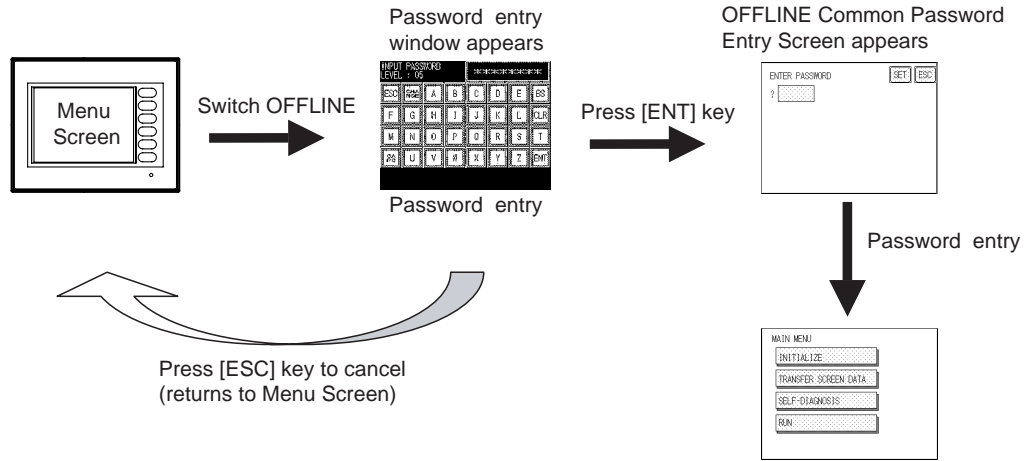

■ **Extend Features**

The screenshot shows the 'Password Settings' dialog box with two tabs: 'Password Setting' and 'Extend'. The 'Extend' tab is active and contains several settings:

- Notification Bit for Password Cancel:** Includes a checkbox for 'Use Notification Bit' and a text field with 'X00000' and a keypad icon.
- Auto Clear Time:** A slider set to '5' minutes.
- Password Enter KeyBoard:** Includes 'Default Settings' with radio buttons for 'Numeric KeyBoard' and 'Text KeyBoard', and a checkbox for 'Request Level Display'.

Annotations provide details for these features:

- When this is clicked/selected, only if a request for screen change is received from a connected device and that request is cancelled, will the designated bit turn ON.** (Points to 'Use Notification Bit')
- When this is clicked/selected, displays the requested screen's security level in the password entry window.** (Points to 'Request Level Display')
- If the GP is not operated or a screen change is not performed within the designated period of time, the GP unit's security level status will automatically change to "0".** (Points to the 'Auto Clear Time' slider)
- Designates the default type of keyboard used to enter the password.** (Points to the 'Text KeyBoard' radio button)

◆ **Notification Bit for Password Cancel**

When the [Use Notification Bit] setting is checked, and the password entry window called up by the Device/PLC unit's screen change is cancelled via pressing the [ESC] key, the designated password cancel notification bit turns ON. (See below)

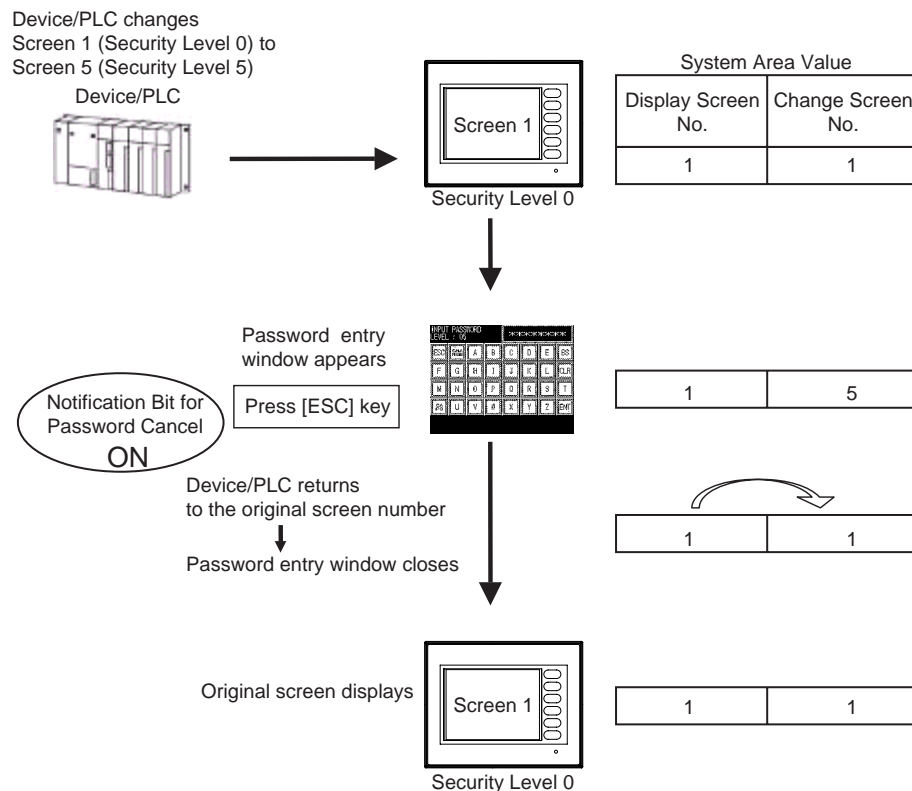

As shown above, while the password entry window is open the System Data Area has two values for the control/recognition of screen numbers - the Display Screen No. and the Change Screen No. When using this feature, please set up your Device/PLC so that it checks if the [Notification Bit for Password Cancel] is ON, and if it is, will return from the [Change Screen No.] to the [Display Screen No.] If the original screen number is returned, the password entry window will automatically close. For more information about Direct Access/ Memory Link Access System Data Area,

**Reference** *Device/PLC Connection Manual*



- This feature is designed only for systems where control is performed via the Device/PLC. Therefore, even if a Function SW/T-tag/D script is used to directly change an GP unit screen, the [Notification Bit for Password Cancel] cannot be used.
- If this feature is not used, and the Device/PLC unit requests a screen change, manually pressing the [ESC] key will not close the screen.

◆ **Auto Clear Time**

This feature sets the length of time (1-60 min.) required before the security level status returns to "0", assuming no GP unit operations/ screen changes are performed.

If "0" is entered for the min. value, the security level status will not be automatically cleared.

◆ **Security Control Address**

When the Auto Clear Time feature is used, the Security Level Control Address' Security Level Clear bit turns ON.

LS9300	Security Level Control
LS9301*1	Security Level Status
LS9302*1	Request Security Level Status

\*1 Read only.

<Security Level Control>

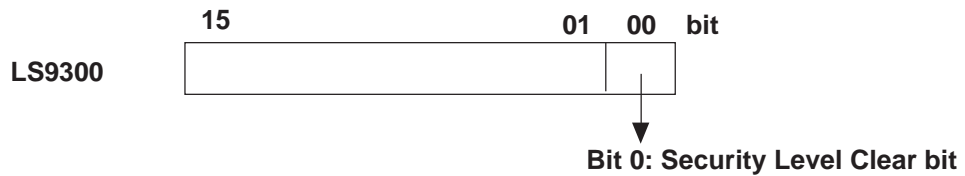

When the bit changes from [0] → [1], Security Level Clear is performed.

<Security Level Status>

This feature stores the value of the current security level, and indicates the maximum security level that requires no password to enter.

<Request Security Level Status>

Stores the security level of the screen to be displayed next.

◆ **Password Entry Window**

This feature automatically displays the following window when the GP unit's security level status changes from the current level to a higher level. You then directly enter the password set in the [Password Setting] tab. Enter the correct password, and press [ENT] to call up the next screen.

Password entered is displayed using "\*" characters.

Shows the security level of the screen/window to be changed to

Switches between upper and lower case

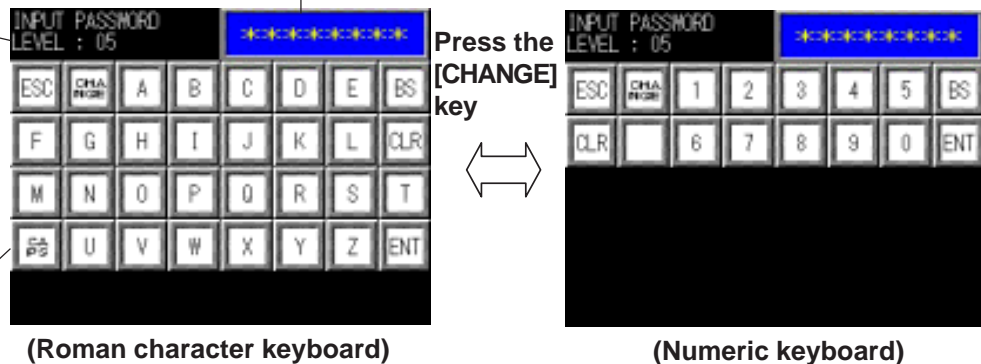



- If the password entered is incorrect, an error message "Incorrect Password" will appear in the window. Also, the GP unit's buzzer will sound. Pressing the [ESC] key will cancel the next screen display, return to the original screen as well as cancel the buzzer and error message.
- If the password entry window does not appear, but an error and the message [Password window cannot be displayed] appears in lower part of the GP unit's screen, close one of the local windows being called up on the GP and perform the screen change again. The password entry window will then appear. Only 2 local windows can be displayed at a time.
- This window cannot be modified.
- Passwords cannot be entered using the Device/PLC unit.
- Passwords cannot be entered using the Bar-Code Reader.

#### ◆ Password Enter KeyBoard

- **Default Settings**

You can designate the default password entry keyboard as being either an alphabet or a numeric character keyboard.

- **Request Level Display**

When this feature is enabled, the security level of the screen being called up next is displayed in the Password Entry window. This feature can only be set via this checkbox. It cannot be set using the GP unit.

■ Entering Password Setting and Extend Tab Settings

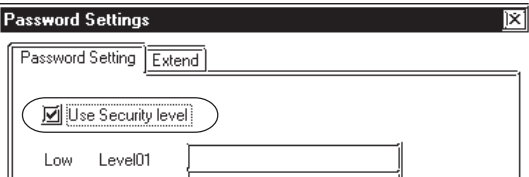
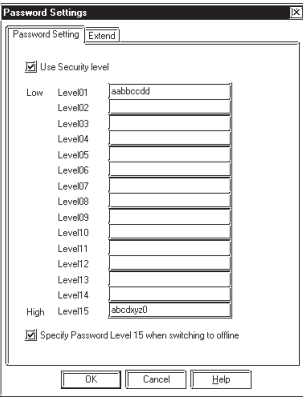
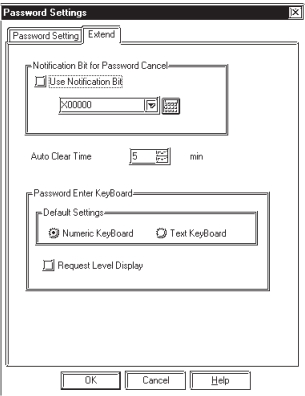
PROCEDURE	REMARKS
<p>(1) Select the Project Manager [Screen/Setup] menu [Security Settings] area [Password Settings].</p> <p>(2) In the [Password Setting] tab, click on [Use Security level] to enable this setting. This will activate the data entry areas.</p> 	<p>Be sure to click the [Use Security level] setting for any projects using the security feature.</p>
<p>(3) Enter a password for the desired level(s) (1 to 8 characters). To set the highest level of security for the GP unit's OFFLINE screens, click the [Specify Password Level 15 when switching to offline].</p> 	<p>Be careful when entering your password - the program recognizes upper and lower case letters. If the [Specify Password Level 15 when switching to offline] box is checked, be sure to check that the Level 15 password is entered.</p>
<p>(4) If necessary, click on the [Extend] tab and enter the desired settings there. When all settings are completed, click <input type="button" value="OK"/> to enter the settings, or <input type="button" value="Cancel"/> to delete all the newly entered settings.</p> 	<p>Setting this item to "0" will cancel the Auto Clear feature.</p>

**4.7.3 Security Level List**

GP-PRO/PBIII for Windows Ver. 7.0 allows you to create a convenient list of all the base screens and windows that are assigned security levels. This is useful when changing each screen's Security Level or editing the screen's Password. You can also change the security level of multiple screens at the same time.



- Before using this feature, be sure to check that the [Security Settings] feature's [Use Security level] setting is enabled.

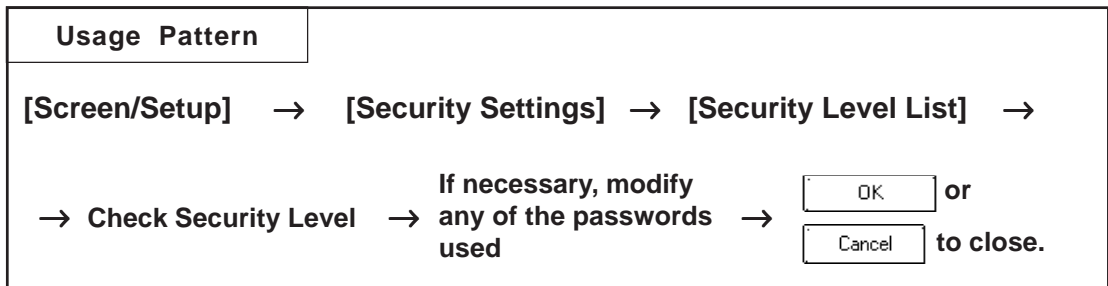

**Security Level List**

**Shows Base (B) and window screens only**

**Each screen's security level**

**Screen Title**

**Changes the list's display format**

Screen No	Security Level	Title
B1	0	Order Accepted
B2	0	Maintenance
B3	0	Production Management
B4	0	Release Schedule
B5	0	Acceptance Inspection
B6	0	Warehouse A
B7	0	Assembly
U1	0	Warning
U2	0	Caution

**Used to enter a change in the level of any screen listed. Level can be from 0 to 15.**

**Clicking allows you to change the security level of the selected screen to a new level.**

**Used to modify a screen's password settings - jumps to [Password Settings] dialog box**

## ■ Editing a Security Level or Password via the Security Level List

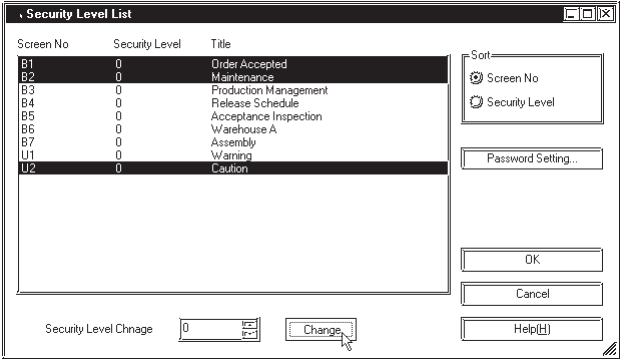
PROCEDURE	REMARKS
<p>(1) Select the Project Manager's [Screen/Setup] menu's [Security Settings] area's [Security Level List].</p> <p>(2) To edit/change a screen's security level, select the screen (multiple screens can be selected), enter the desired level in the [Security Level Change] and then click on the <input type="button" value="Change"/> button. The change will be reflected in the List.</p> 	<p>Be sure to click the [Screen/Settings] area's [Password Setting] window's [Use Security level] setting for any projects using the security feature.</p> <p>The Security Level List can be listed and edited even when saved as a given name or changed the screen's title.</p> <p>When a screen is opened, its security level can be listed, however, it cannot be edited.</p>
<p>(3) To change the screen's password, click on [Password Setting] button. The screen changes to the [Password Setting] dialog box. For information about Password entry, <b>Reference</b> 4.7.2 Password Settings</p>	
<p>(4) When all settings are completed, click <input type="button" value="OK"/> to enter the settings, or <input type="button" value="Cancel"/> to delete all the newly entered settings.</p>	



# 4.8 Time Schedule

This feature will reset, or set, bits or words according to a pre-set date/time schedule.



- **The Time Schedule feature is available only with GP2000 Series units.**

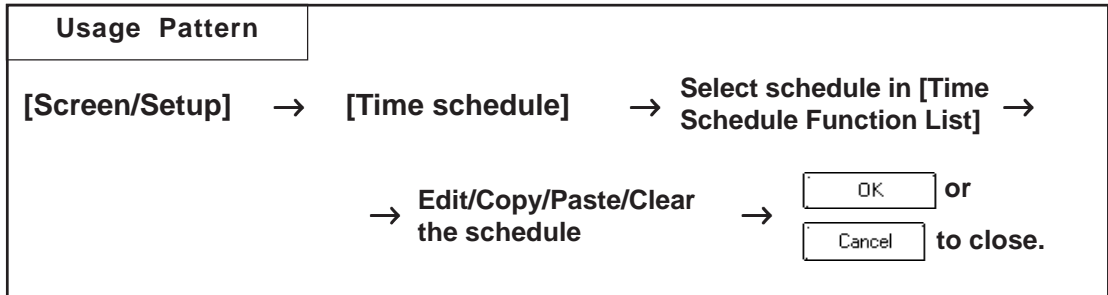

## 4.8.1 Overview

This feature will reset or set bits or words according to a pre-set date/time schedule. If this feature is set to activate the control addresses used for Filing Data (Recipes), or D-Script, these features will then operate on the designated day/date.

[Example]

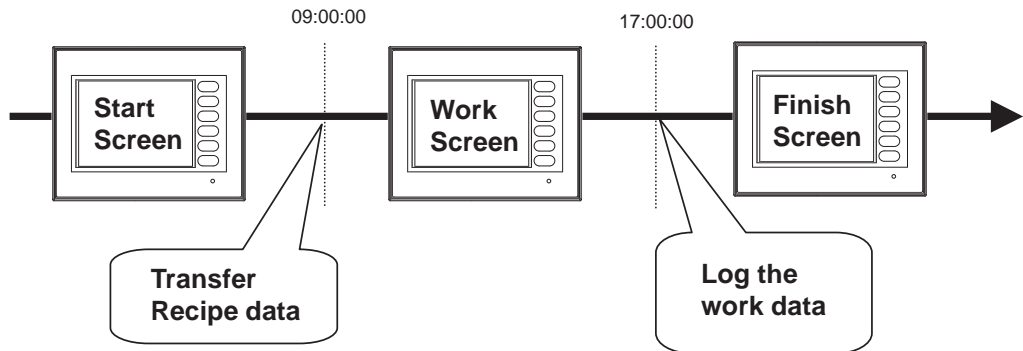

- **Time Schedule settings cannot be entered via the GP unit's OFFLINE screens. These settings can only be entered via the editor software's setting menu.**

Position	Operation	Address	Type	Setting Address	Start Time	End Time	Day
1	Bit Set	x00000	Direct	-----	08:00:00	07:00:00	Sun,Mon,Tue,Wed,T
2	Word Set	D00000	Indirect	D00000	-----	-----	-----
3	Bit Set	x00000	Direct	-----	09:00:00	18:00:00	Mon-Fri
4							
5							
6							
7							
8							
9							
10							
11							
12							

- Allows you to update/edit the settings used for any Time Schedule entries
- Copies the Time Schedule
- Pastes the copied schedule
- Clears the selected schedule data



- **A single project may have up to 32 Time Schedule items.**

**4.8.2 Entering Time Schedule Settings**

**■ Time Schedule Settings**

Simply double-click on the Time Schedule Function List's left-side item list (1, 2, 3, etc.) or click once on the row to select the item and click on

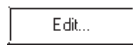

to call up the Time Schedule Function dialog box.

The following features become available.

**Selects the operation mode.**

**Depending on the Operation Mode selected, designates the address to operate.**

**If the Operation Mode has been set to Word Set16 or Word Set32, this area is activated. This area allows you to directly enter data for the start and finish write values.**

**If the Prohibit Operation Bit is ON, the schedule/operation is not performed.**

**Enter the value written to the address when the schedule finishes.**

**When this feature is enabled, as soon as the GP unit's power is turned ON, the range of the schedule is recognized. If the GP unit's power is turned ON during (inside) the scheduled range, the start time/operation will be performed. If the GP unit's power is turned ON outside of the scheduled range, the end time/operation will be performed.**

**Designates the word write value's sign and data format.**

**Enter the value written to the address when the schedule starts. If the [Time Settings] tab's End Operation is not enabled (checked), you cannot enter data in this area.**

**◆ Operation Mode**

When entering the settings for an item in the Time Schedule Function List, the operation mode settings must be selected. These settings include, [Bit Set], [Bit Reset], [Word Set16] (16-bit write), and [Word Set32] (32-bit write).

**Operation example 1: Bit Set**

When [Bit Set] is selected, the following operations are performed:

**Operation example 1 : Bit Set**  
**Start Time** : 09:00:00  
**End Time** : 17:00:00

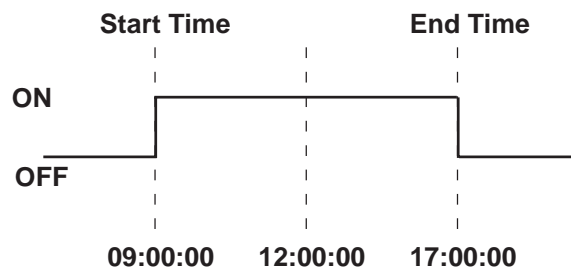

**Operation example 2: Bit Reset**

When [Bit Reset] is selected, the following operations are performed:

Operation example 2 : Bit Reset  
 Start Time : 09:00:00  
 End Time : 17:00:00

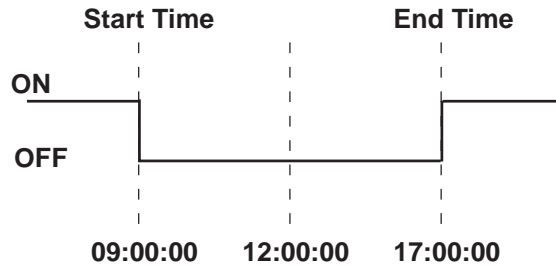

**Operation example 3: Word Set**

Selecting [Word Set] performs the following operations.  
 This mode's selections include 16 bit and 32 bit.

Operation Mode : Word Set  
 Device Address : D0100  
 Start Write Value : 10  
 End Write Value : 0  
 Start Time : 09:00:00  
 End Time : 17:00:00

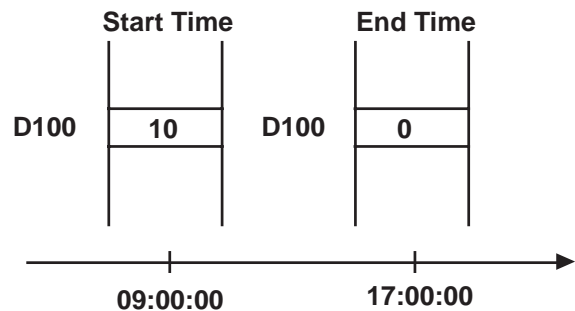

◆ **Operation Address**

Designates the address used to control the schedule.

◆ **Start/End Time Operation when Power is switched on.**

When this feature is enabled, as soon as the GP unit's power is turned ON, the range of the schedule's start and finish times is recognized. If the GP unit's power is turned ON during (inside) the scheduled range, the start time/operation will be automatically performed. If the GP unit's power is turned ON outside of the scheduled range, the end time/operation will be automatically performed.



- If this feature is disabled, and power is turned ON inside the schedule range, but the start time has not already been passed, the start time/operation is not automatically performed. However, the end time/operation will automatically be performed.
- If the end time/operation is not set in the schedule, this feature will not be performed.

◆ **Word Settings**

These settings are active only when the Operation Mode is set to [Word Set16] (16-bit write) or [Word Set32] (32-bit write).

- **Direct**

Designates the word write value's sign and data format. If [Dec] and [Code+/-] are selected, negative values can be set.

The [End value] is enabled only when the [Extend] tab's [End Day Operation Setting] is checked.

- **Indirect**

Designates the address used to store the Start time and End time values.

◆ **Prohibit Operation Bit**

When this feature is selected, at the beginning of the schedule, the designated value will be read out from the Prohibit Operation bit's address. If the Prohibit Operation Bit is ON, the schedule/operation is not performed.

■ **Time Settings**

The following explanation describes the settings in the Time Schedule Function's [Time Settings] tab.

◆ **Direct**

Directly designates the start/end time.

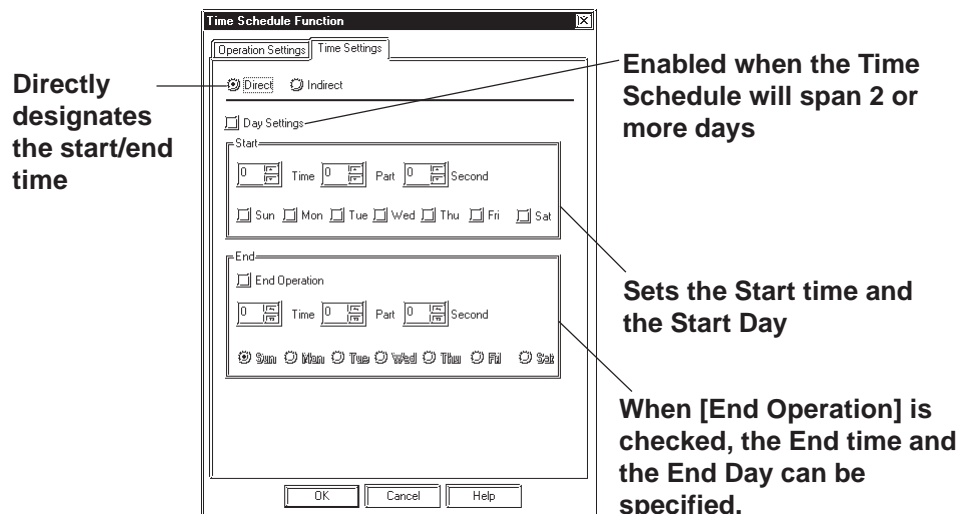

◆ **End Day Operation Setting**

**<When enabled>**

Can be set if the Time Schedule spans 2 or more days.

- Only one day can be set for the start day.
- Only one day needs to be set for the end day. [End Operation] is automatically enabled.
- Enter the Start and End times.



- **Start and End times cannot be the same time on the same day.**

**<When disabled>**

A schedule that is 1 day (Start and End times are within 24 hours) can be entered.

- Multiple Start days can be selected.
- Be sure to click on [End Operation] when setting the End time.



- **Be sure to select one or more start days.**
- **Start and End times cannot be the same time.**
- **The Time Schedule (mentioned here) is for one day only, so if the End time is entered as being before the Start time, the End time will be performed on the next day.**

E.g.)    **Start Day : Monday**  
           **Start Time : 22:00:00**  
           **End Time : 01:00:00**

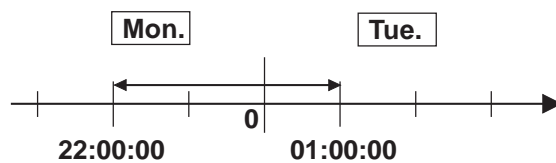

◆ Indirect

Indirectly designates the Time Setting data in the Time Setting Address.

**Indirectly designates the address used to store time setting data.**

**Designates the address used to store time setting data.**

**Addresses used for storing time setting data.**

◆ Time Setting Address

Designates the addresses used to store time settings data read out from a Device/PLC.

Address+0	Control
Address+1	Status
Address+2	Operation Mode
Address+3	Start Time (Day)
Address+4	Start Time (Time)
Address+5	Start Time (Part)
Address+6	Start Time (Second)
Address+7	End Time (Day)
Address+8	End Time (Time)
Address+9	End Time (Part)
Address+10	End Time (Second)

<Control: Address + 0> (Device/PLC → GP)

When the Time Read Request bit's 0 → 1 change (rise) is detected, the Operation Mode, Start Time, and End Time are read out.

15	01	00 (bit)
Reserved		0

**Bit 00** : Time Read Request Bit (0: No action, 1: Perform Time Read)  
**Bit 01-15:** Reserved (Be sure the set value is fixed to "0".)



- Data is not read out regularly, from the Time Setting Address operation mode (address +2) to the End Time (sec.)(address +10). When reflecting Time Setting Data changes in the GP unit, be sure to set the Control bit (address +0) from "0" to "1".

<Status: Address + 1> (GP → Device/PLC)

After the Control's time data readout is completed, the GP unit will turn the Time Read Completion Bit ON (0 → 1). If the time data entered is incorrect, simultaneously the Error Alert Bit will turn ON (0 → 1).

15	02	01	00 (bit)
Reserved		0	0

- Bit 00** : Time Read Completion Bit (0: Either Time Read is being performed or had not yet been performed, 1: Time Data Read Completed)
- Bit 01** : Error Alert Bit (0: Time data is being replaced with correct data. 1: Time data contains an error.)
- Bit 02- Bit 15** : Reserved (Be sure the set value is fixed to "0".)



- **Once the Time Read Completion bit's rise (trigger) is recognized by the Device/PLC, be sure to turn the Control Time Read Request bit OFF (1 → 0). Once this bit is turned OFF, the Status's Time Read Completion bit and the Error Alert bit will automatically and simultaneously be turned OFF (1 → 0).** (See below)

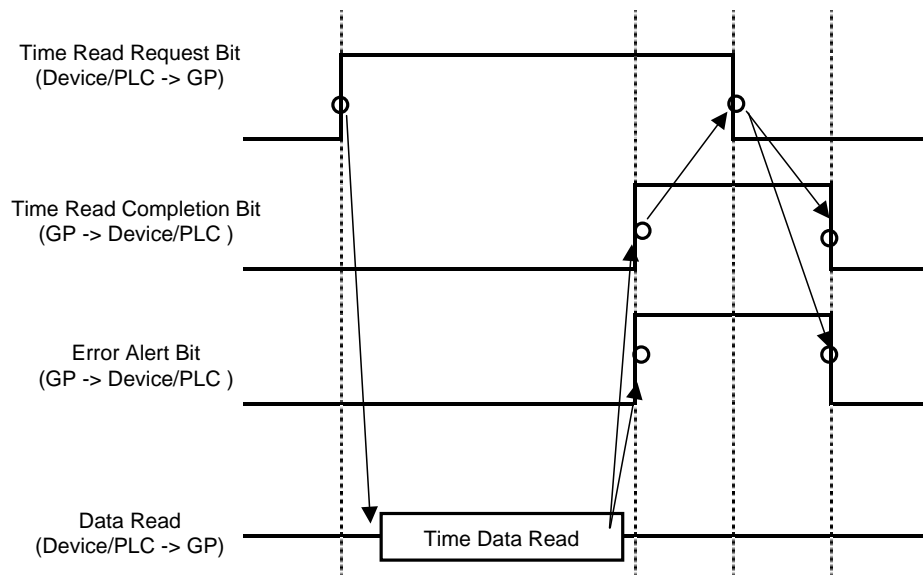

**<Operation Mode: Address + 2>**

Set if the End Operation and the End Day Operation Settings are enabled/disabled. However, regardless of the End Operation status (enabled/disabled), the indirectly designated time data (Time Setting address's total 11 Word) is all read out.

15	02	01	00 (bit)
Reserved		0	0

- Bit 00 : End Time Action Setting (0: None, 1: Used)
- Bit 01 : Day Setting Mode (0:None, 1: Used)
- Bit 02 - Bit 15 : Reserved (Be sure the set value is fixed to "0".)

**<Start/End Time (Day): (Start) Address + 3, (End) Address + 7>  
(Device/PLC → GP)**

Designates the day used as a trigger for the Start/End action.

15	07	06	05	04	03	02	01	00 (bit)
Reserved		Sat.	Fri.	Thu.	Wed.	Tues.	Mon.	Sun.

- Bit 00 : Sunday (0: None, 1: Designate)
- Bit 01 : Monday (0: None, 1: Designate)
- Bit 02 : Tuesday (0: None, 1: Designate)
- Bit 03 : Wednesday (0: None, 1: Designate)
- Bit 04 : Thursday (0: None, 1: Designate)
- Bit 05 : Friday (0: None, 1: Designate)
- Bit 06 : Saturday (0: None, 1: Designate)
- Bit 07 - Bit 15 : Reserved (Be sure the set value is fixed to "0".)

**<Start/End Time: (Start) Address + 4 to +6, (End) Address + 8 to +10>**

Here, you enter the time values used for the Start and End operations. The following time setting example is used.



- The setting/not setting of the End Time will depend on the Operation Mode (address +2) setting. Also, the End Time Action Setting (bit 00) available will depend on the Day Setting Mode (bit 01) used. The following chart shows what combinations/selections are available.

Day Setting Mode	Used	Not Used	
End Time Action Setting	Used	Used	Not Used



[Setting Example 1]

Operation Date : Tuesday, Thursday (within 24 hours)

Start Time : 9:30:00

End Time : None

Address+2 (Operation Mode)	15								02	01	00	bit						
													0 0					
Address+3 (Start Time - Day)	15								07	06	05	04	03	02	01	00	bit	
																		0 0 1 0 1 0 0
Address+4 (Start Time - Hour)	15															00	bit	Enter any value from 0 to 23 in Binary*1
																9		
Address+5 (Start Time - Minute)	15															00	bit	Enter any value from 0 to 59 in Binary*1
																30		
Address+6 (Start Time - Second)	15															00	bit	
																0		

**Note:** • If a "0" (Not Used) is entered in the Day Setting Mode, the End Time (Day/ Hour/Minute/Second ) data will be read but it will be ignored.

\*1 BCD input cannot be used. If the value is entered is outside of the allowed range, the unit may not operate correctly.

[Setting Example 2]

Operation Date : Monday to Friday

Start Time : 9:30:00

End Time : 18:00:00

Address+2 (Operation Mode)	15								02	01	00	bit													
										1	1														
Address+3 (Start Time - Day)	15								07	06	05	04	03	02	01	00	bit								
										0	0	0	0	1	0	0									
Address+4 (Start Time - Hour)	15															00	bit	Enter any value from 0 to 23 in Binary <sup>*1</sup>							
																9									
Address+5 (Start Time - Minute)	15															00	bit	Enter any value from 0 to 59 in Binary <sup>*1</sup>							
																30									
Address+6 (Start Time - Second)	15															00	bit								
																0									
Address+7 (End Time - Day)	15															07	06	05	04	03	02	01	00	bit	
																0	1	0	0	0	0	0	0		
Address+8 (End Time - Hour)	15																						00	bit	Enter any value from 0 to 23 in Binary <sup>*1</sup>
																							18		
Address+9 (End Time - Minute)	15																						00	bit	Enter any value from 0 to 59 in Binary <sup>*1</sup>
																							0		
Address+10 (End Time - Second)	15																						00	bit	
																							0		



• If a "1" (Used) is entered in the Day Setting Mode, be sure to enter all Start and End time (Day, Hour, Minute, Second) information. However, if 2 or more of the Start/End time (Day) bits turns ON simultaneously, an error will occur.

\*1 BCD input cannot be used. If the value is entered is outside of the allowed range, the unit may not operate correctly.

■ Usage Restrictions

- The Time Schedule features are "one-shot" operations. In other words, when the Start time is reached, the designated device address is written to just once. The write operation is not repeated.

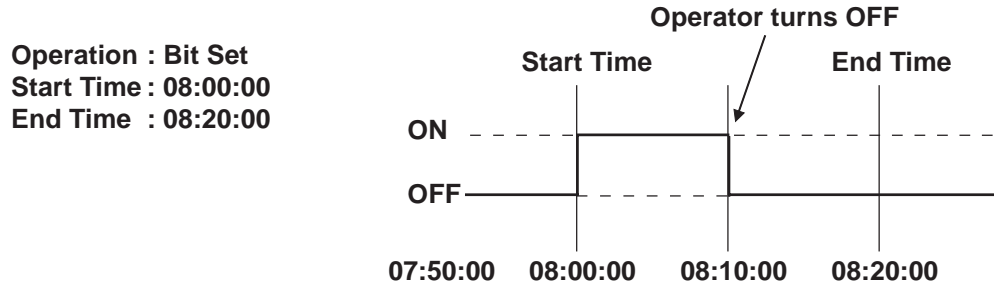

- When changing GP Time Settings, the range of the schedule's start and finish times is recognized. If the edited item is inside the scheduled range, the start time/operation will be automatically performed. If the edited item is outside of the scheduled range, the end time/operation will be automatically performed.



- **If the end time/operation is not set, the schedule's range cannot be confirmed and this feature will not be performed.**
- If the Start Time Operation is completed and then becomes a "Power Out" condition, the schedule's range will be recognized and the End operation will be performed at the End Time.

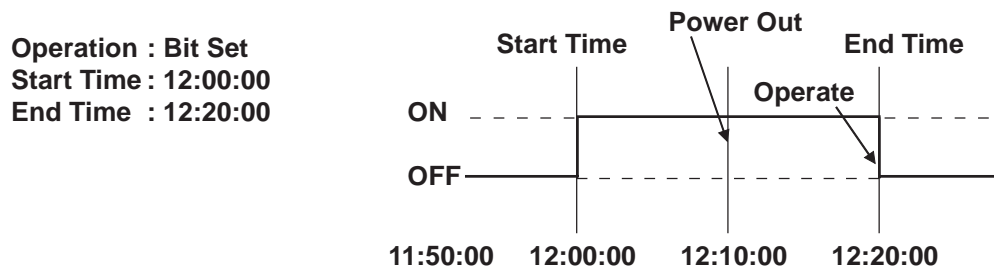

- If the Time Setting is designated as indirect, only the Time Setting Address Control's (Address +0) will be read out with High Speed. Up to 32 Time Schedule settings can be entered, however, if all Time Settings are all designated as indirect, 32 Control addresses (address +0) will need to be continuously read out and the GP unit's overall performance may be effected.
- When "Indirect" is used, the Time Setting address control's (address +0) normal readout speed is once every 500ms.  
When the Control Address bit 00 (Time Read Request Bit) changes from 0 to 1, a delay of up to 500ms may occur before the Time Status (address +1) and onwards data is read out.  
Also, when multiple Control (address +0) bit 00 (Time Read Request Bit) simultaneously change from 0 to 1, in order that operations can be started in the order set, a delay may occur before an operation is performed.
- The Word Write Value setting's Start/Stop Write Value's indirect setting, and the Prohibit Operation bit monitoring are read only once, at the beginning of the Time Schedule. Since regular readout is not possible, there may be a slight data communication delay that causes the designated operation's Start Time to not be performed at exactly the Second setting entered.

# 4.9 Symbol Editor

The Symbol Editor enables you to assign an address to a symbol and then register that symbol and to assign a device comment to an address and then register it.

The “Symbol” is the registered name used to indicate the address of any Tag or Part. Thus, when you change the address corresponding to a symbol, you will automatically change a Part or Tag's address(es) without having to re-setting the Tag or Part. The “device comment” indicates a comment assigned (attached) to each address. When setting a Tag or Part's address(es), simply clicking on  ([Apply Device Comment]) reflects the registered device comment to the Tag or Part's comment field.

**Reference** 2.1 Parts ■ *Entering a Comment*

In all the address entry fields, such as of Tags and Parts, addresses registered via the Symbol Editor will be displayed in a pull-down list together with the symbols or device comments. Addresses can also be specified here by selecting them from this list.

**Reference** 2.1 Parts ■ *Entering Addresses*

The symbol and device comment data can be shared between multiple Projects by import and export.



**Note:** The registered symbol and device comment information can be printed as a symbol list.

**Reference** 9.1.1 *Printing*

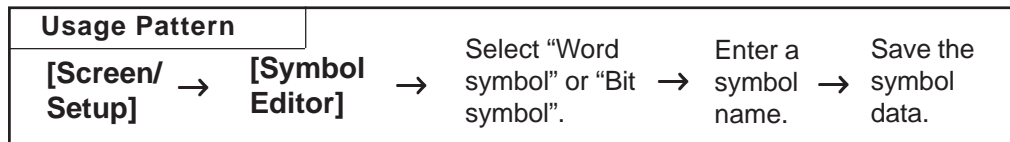

## ■ Symbol Editor Types

There are five types of symbols: “Word” symbol, which corresponds to a word address, “Bit” symbol, which corresponds to a bit address, “GLC Integer” symbol, “GLC Discrete” symbol, and “GLC Real Number” symbol that all correspond to GLC symbols.



- GLC symbols can be used only on GLC Series and LT Series units.

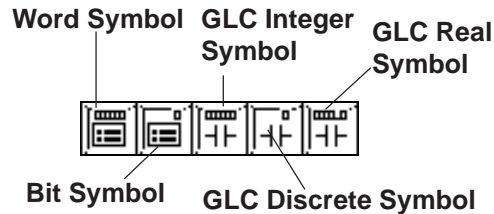

**Reference** For detailed GLC symbol information, refer to *Pro-Control Editor Operation Manual* (packaged with the *Pro-Control Editor*)

## ◆ GLC Symbols

A “GLC symbol” means variables used in a logic program. A new GLC symbol cannot be registered with the Symbol Editor. When a logic program is saved, global variables registered on the variable list will automatically be registered in the Symbol Editor.

Only global variables are registered as GLC symbols.

Depending on their type, variables are registered as one of the following three GLC symbols: **GLC Integer symbol**, **GLC Discrete symbol**, **GLC Real symbol**.

For array variables, each element is registered as a symbol. An array of size 5 is registered as five GLC symbols. [Element Number] representing elements in an array will be <Element Number> as a GLC symbol, and an array of size 5, ALLM, will be represented as shown below.

Array variable	GLC symbol
ALLM[0]	ALLM<0>
ALLM[1]	ALLM<1>
ALLM[2]	ALLM<2>
ALLM[3]	ALLM<3>



For detailed variable information, please refer to the "Logic Programming Operation Manual" or "online help".



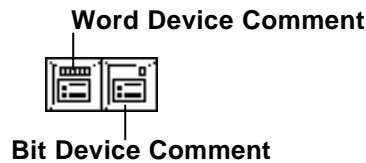

## ■ Device Comment Types

There are two types of device comments: the word device comment corresponding to a word address and the bit device comment corresponding to a bit address.



## ■ Edit Commands

To edit symbols, you can use the following commands:

-  ..... Used to delete a symbol's line of data and store it on the clipboard. The Paste command allows you to then move that symbol data to another line.
-  ..... Used to copy a selected line of data to the clipboard.
-  ..... Used to insert the line of data temporarily stored on the clipboard into the desired row, after the Cut/Copy command has been performed.
-  ..... Used to cancel the command previously performed and return to the previous condition. However, a changed symbol character cannot be restored.

## ■ Using the Cut/Copy/Paste Commands

Cut/Copy/Paste commands can be used to move data between different Symbol Editor files. To do this, simply open another LBE file and select a desired line. Then, use the [Cut] or [Copy] command, and then the Symbol Editor's [Paste] command.



- ***Do not register the same symbol name for both a word symbol and a bit symbol.***
- ***Offset symbol can be specified by setting "+" and numerical values to a symbol. Due to this, "+" cannot be used to the symbol names registered as symbols on the Symbol Editor.***





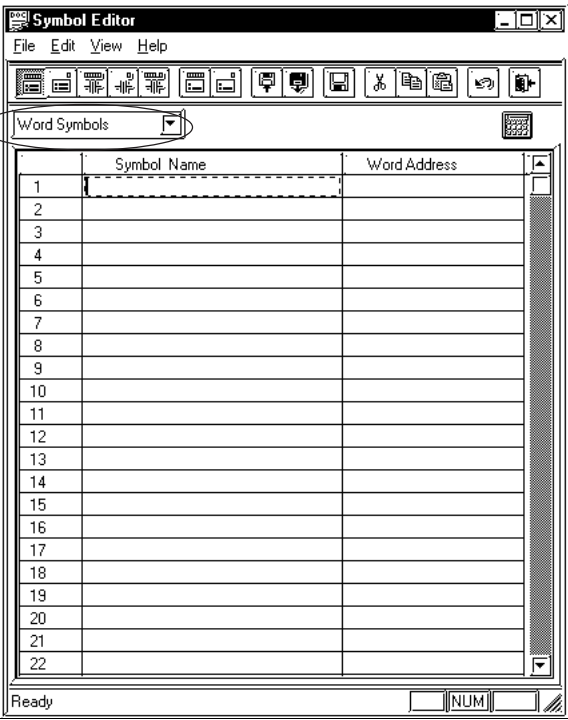

- **If alphanumeric numerals are used at the end of a symbol name, executing the [Copy] and [Paste] command will automatically change the symbol's name.**
- **When Chinese characters and numbers are used in a symbol name:**  
**All the Arabic numbers to the right of the Chinese character(s) will be deleted. Sequence numbers starting from "2" will be assigned after the Chinese characters.**
- **When Roman characters and Arabic numbers are used in a symbol name:**  
**Example) ABC123**  
**All the Arabic numerals to the right of Roman character(s) will be deleted and replaced by a sequence number.**
- **When only Arabic numbers are used in a symbol name:**  
**Only the first number is retained, and all other digits are truncated and replaced with a sequence number.**

■ Registering Symbols and Device Comments

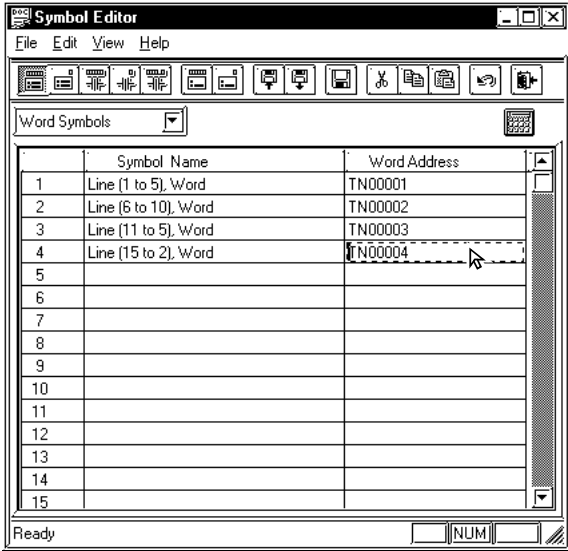
PROCEDURE	REMARKS
<p>(1) Via the Project Manager, select the [Screen/Setup] menu - [Symbol Editor] command.</p> <p>(2) Select symbol or device comment type.                      In this example, please select "Word Symbols".</p> 	<p>If the Project's [GP Type] is an GLC/LT Series unit, the GLC symbol can be specified.</p> <p><b>Reference</b> <i>Pro-Control Editor Operation Manual (packaged with the Pro-Control Editor)</i></p>



PROCEDURE	REMARKS
<p>(3) Enter symbol names and addresses.</p>  <p>(4) After all the necessary items are registered, select the [File] menu - [Save] command, or click on the  icon.</p>	<p>To enter a symbol name, you can use up to twenty alphanumeric characters, or up to ten Chinese characters.</p> <p>The entered characters are not case-sensitive.</p> <p>You can perform the [Delete] or [Copy] and [Paste] commands after selecting multiple messages.</p> <p> <i>Important</i></p> <p><b>The symbols [], \, ?, and the  key cannot be used in the Symbol Editor.</b></p>

### ■ Importing Symbols and Device Comments

The previously saved Symbol Editor data can be imported to and shared with the currently open Symbol Editor. Files with the extension of "\*.LBE" or "\*.CSV" can be imported.

CSV files that have been created via a text editor, Microsoft Excel, or other applications can be used as symbol or device comment data after they have been imported via the Symbol Editor.

Symbol data and device comment CSV file formats are as follows:

#### <Symbol Data CSV Format>

```
"GP_SYMBOL"
"Symbol Name", "Word Address"
<Insert one return between a word address and a bit address>
"Symbol Name", "Bit Address"
```

#### Example

```
"Line A (1 to 5): Word", "D00100"
"Line A (6 to 10): Word", "D00101"
"Line A (1 to 5): Bit", "X00100"
"Line A (6 to 10): Bit", "X00101"
```

> One return

<Device Comment Data CSV Format>

```
"GP_COMMENT"
"Word Address", "Device Comment Name"
<Insert one return between a word address and a bit address>
"Bit Address", "Device Comment Name"
```





**Example**

```
"GP_COMMENT"
"D00100", "Machine A stops"
"D00101", "Machine A is now operating"
"X00100", " Pump B"
"X00101", " Pump B"
```

} One return

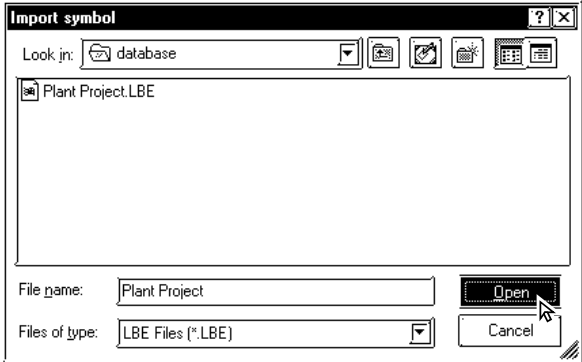

- "GP\_SYMBOL" and "GP\_COMMENT" are identifiers indicating they are Symbol and Device Comment Data, respectively.
- Insert only one return between a word symbol and a bit symbol. If additional returns are entered in other lines, data cannot be imported.

PROCEDURE	REMARKS
<p>Import symbol data.</p> <p>(1) Select the [File] menu - [Import Symbol] command, or click on the  icon.</p> <p>(2) Select a file (*.LBE or *.CSV) to be imported or enter the file name, and click on the  button.</p>  <p>If the same symbol name already exists, the system asks if you wish to replace the symbol name.</p>	<p>To import a device comment, select the [Import Device Comment] command.</p>  <p><b>To import a device comment, select the [Import Device Comment] command.</b></p>

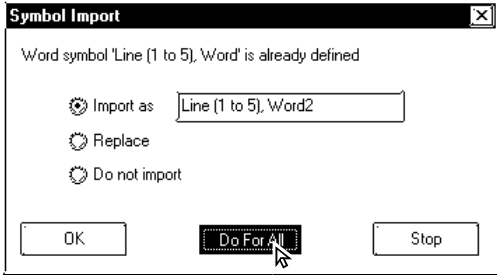
PROCEDURE	REMARKS
<p><b>(3) Select an import method and execute it.</b></p> <p>To import the specified symbol according to the current settings, click on the <input type="button" value="OK"/> button. To import the current Project file's all the symbols according to the current settings, click on the <input type="button" value="Do For All"/> button. To cancel the import, click on the <input type="button" value="Stop"/> button.</p> 	<p><b>[Import as]</b> Enter the symbol name to be replaced. If no symbol name is entered, the original symbol name plus sequence numbers will be imported.</p> <p><b>[Replace]</b> The same symbol name will be overwritten.</p> <p><b>[Do not import]</b> The same symbol name will not be imported.</p>



- **GP-PRO/PB III for Windows includes the utility "CMTCNV.EXE", a tool to convert Mitsubishi Electric's Windows GPP function software SWOD-GPPW comment data to CSV files. For more detailed information about this tool, refer to "Readme.txt" in the folder "\\ProPBWin\CMTCNV" created at GP-PRO/PB III for Windows installation.**
- **The maximum number of device comment characters is 20 in single byte.**
- **Items with unrecognizable device names are not imported.**

**■ Exporting Symbols and Device Comments**

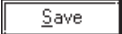
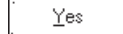
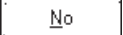
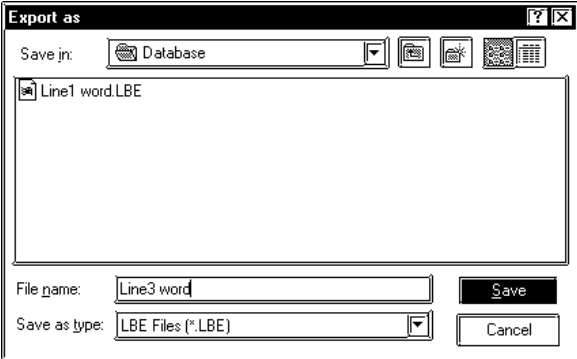
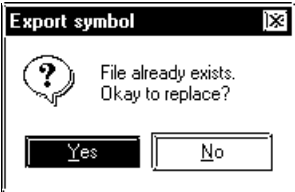

Data registered via the Symbol Editor is exported and saved as an LBE or CSV file. By importing this data, the Symbol Editor data can be shared among Projects.

PROCEDURE	REMARKS
<p>Export symbol data.</p> <p>(1) Via the Symbol Editor, select the [File] menu - [Export Symbol] command, or click on the  icon.</p> <p>(2) Specify the name and type (*.LBE or *.CSV) of the file to save the exported data with, and click on the  button.</p> <p>If the same file name already exists, the system asks if the existing file must be overwritten. If it must be overwritten, select . If you do not wish to overwrite it, select .</p>  <p style="text-align: center;">↓</p> 	<p>To export a device comment, select the [Export Device Comment] command.</p>

■ **Calling up Device Comments**

Comments previously registered with Tags and Parts can be called up on the Symbol Editor as device comments. For addresses corresponding to each Tag and Part's comment, refer to the Input Description Address Table.

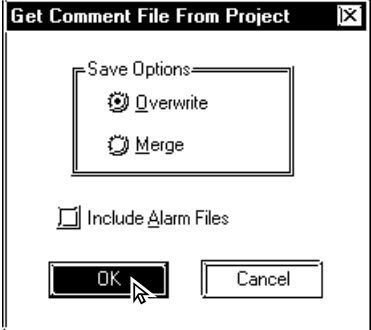

**Reference** 2.4.7 Duplicate

PROCEDURE	REMARKS
<p>(1) Select the [File] menu - [Get Device Comment From Project].</p> <p>(2) Select a device comment calling up method and click on the <input type="button" value="OK"/> button.</p> <p>[Overwrite] ... The device comment is called up after the already assigned address is deleted.</p> <p>[Merge] ... The device comment is called up in addition to the already assigned address.</p> 	 <p><b>Important</b></p> <p><b>Multiple addresses may be given to a tag or part depending on its type. In this case, device comments will be called up for all the assigned addresses.</b></p> <p>To call up an alarm message from the Alarm Editor, mark the [Include Alarm Files] check box.</p>

## 4.10 Device Monitor

You can monitor and change a desired area of device memory via the GP unit's Global Window screen. In this section, you must specify whether or not to register the "device monitor" command for the current GP unit. This registration is effective only when GP and PLC types which support the device monitor command are selected.

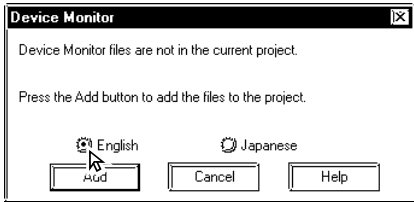
**Reference** *Device/PLC Connection Manual, Appendix 3: Device Monitor*

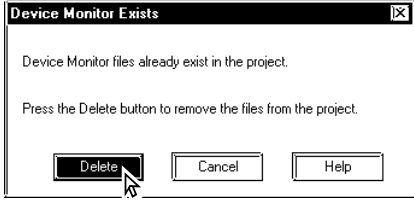
PROCEDURE	REMARKS
<p>(1) <b>Select the [Screen/Settings] menu - [Device Monitor] command.</b> Register the Device Monitor.</p> <p>(2) <b>Specify which version of device monitor is to be used, the Japanese version or the English version.</b></p>  <p>(3) <b>Click on the <input type="button" value="Add"/> button.</b> This completes registration of the device monitor feature. After the registration is completed, the following message appears.</p>  <p>To cancel the device monitor registration data, the following message will appear in step (2). Then, click on the <input type="button" value="Delete"/> button to cancel it.</p> 	<p>If you change the Device/PLC type after the device monitor command is registered, the device monitor command will not operate correctly on the GP unit. To change the Device/PLC type, first, delete the device monitor registration before saving the current file.</p> <p>To use the device monitor command, be sure to select the "Indirect (Binary)" operation mode in the [GP Setup] - [Extended Settings] - [Global Window Settings].</p>

# 5

# CREATING AND EDITING ALARMS

**T**his feature allows you to register text data to be displayed as alarm messages. This chapter describes how to create and edit these alarm messages.

## 5.1 .....Alarm Creation and Editing

# 5.1 Alarm Creation and Editing

With this feature you can register the messages to be displayed in the “Alarm Summary” (specified by an “a-Tag”, a “Q-Tag” or an “Alarm Part”) and “Alarm Message” (right to left scrolling display). You can also set up a monitor bit for each message. According to the monitor bit’s ON/OFF status, the specified messages are then displayed in the “Alarm Summary” or “Alarm Message” mode.

**Reference** *Tag Reference manual, 2.2 a-tag (Alarm Summary Display), 2.20 Q-tag (Alarm Summary bit log/word Display)*

The “Alarm Summary” mode lists messages. The “Alarm Message” mode displays a flowing message at the bottom of the screen.

With “Alarm Message” text, the horizontal and vertical size of the text is specified in the [Setup Area’s (Initial Setup screen)] menu or in the GP unit’s [Setup] mode. Character sizes can be set to either “x 1”, “x 2”, or “x 4”.

When the horizontal and vertical sizes are set to “1 x 1”, an alphanumeric character occupies 16 x 8 dots, and a Chinese character occupies 16 x 16 dots. The “Alarm Summary” and “Alarm Message” will display on the GP unit’s panel screen as shown below:

Alarm Summary Display      Alarm Message Display

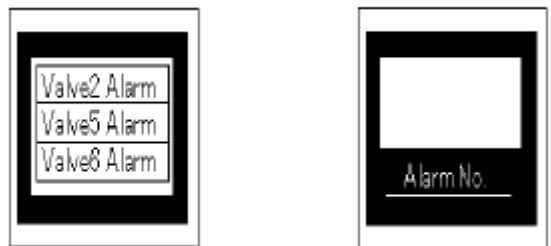

← Right to left scrolling display

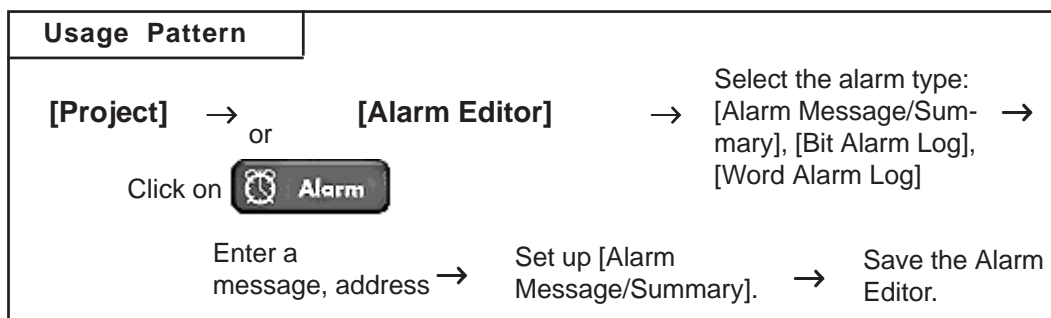



**5.1.1 Alarm Editor**

Via the Alarm Editor, messages and monitor bits are registered for each alarm type. An example of an Alarm Message screen used for entering a message is as follows. The Alarm Editor provides three types of alarms: [Alarm Message/Summary], [Bit Alarm Log] and [Word Alarm Log].

Bit Alarm Log



Alarm Message/  
Summary

Word Alarm Log



**Note:** The tab width for each item in the Alarm Editor (message/bit log/word log) can be adjusted by positioning the mouse pointer on the border between items and then dragging it. The changed size will be saved, and used on the subsequently opened screens.

■ **Alarm Message/Summary Screen**

Here, you can register the messages to be displayed as either “Alarm Summary” (specified by an “a-Tag” or an “Alarm Part”) or as “Alarm Message” (right to left scrolling display). The message can be registered up to 8999 lines.

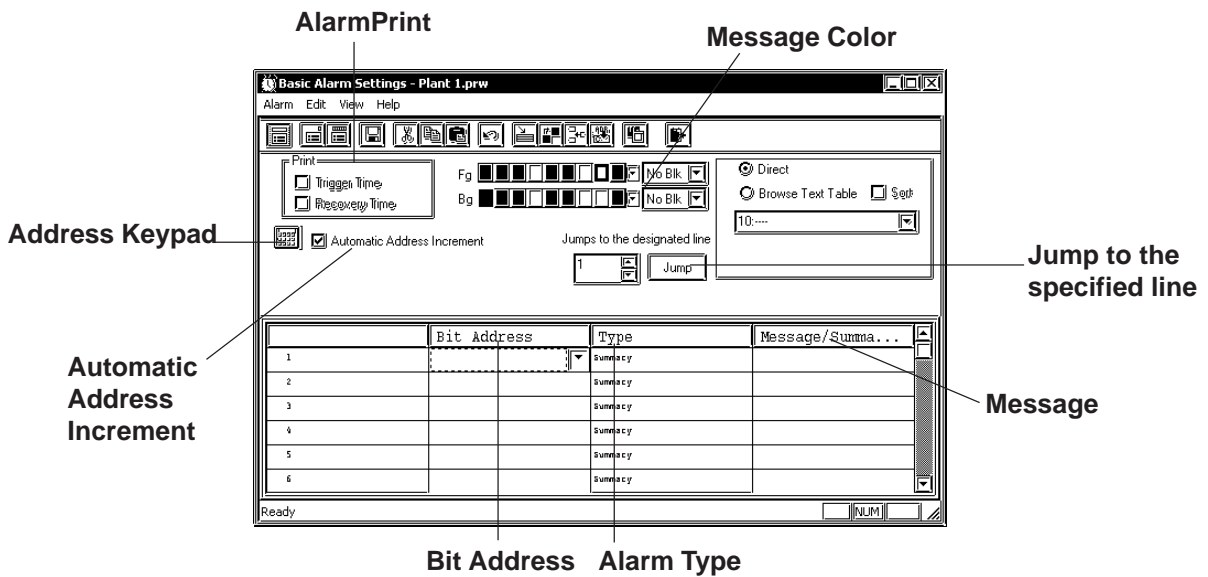

◆ **Direct**

The text entered in the Selected Message field is placed directly as a fixed character string.

The message is displayed in a single line. Up to 16 types of messages can be displayed in each Message Display.

◆ **Browse Text Table**

Select or add the Text registered in the Text Table Editor. Two or more lines of messages can be displayed.

▼ **Reference** 4.6.3 ■ *Selecting Table Editor Text* ◆ *Entering Table Editor Text*



- **Multi-language Display Feature is supported by GP-377/GP77R/ GP2000 Series units.**
- **When designating “Browse Text Table”, Alarm Import/Export feature cannot be used.**

#### ◆ Address Keypad

An address keypad is displayed, allowing you to enter the bit address using the mouse.

#### ◆ Bit Address

Specifies the monitor bit. To specify the bit address for the “Alarm Summary” mode, select a device that can be specified by word.

▼ **Reference** X *Device/PLC Connection Manual*

#### ◆ Alarm Type

The Alarm Editor provides two types of alarms: [Alarm Summary] and [Alarm Message].

The [Alarm Summary] mode lists messages specified by an “a-Tag” or an “Alarm Part”.

The [Alarm Message] mode displays a scrolling message at the bottom of the GP’s screen. Up to 512 messages can be entered into the Alarm Editor (up to 128 messages for GP70 series units). However, the monitor bit does not exceed 128 words. Any message beyond this setting range will not operate on the GP unit’s panel screen.

#### ◆ Message

Enter your message here. Although up to 160 alphanumeric characters can be entered for one message, the maximum number of characters that can be displayed depends on the GP unit. With the GP-377, GP77R and GP2000 series, selecting the [Browse Text Table] feature allows you to use the text registered in the Text Table Editor to change message text.

▼ **Reference** X *4.6.3 Entering Settings via the Screen Editor* ◆ *Selecting Alarm Editor Messages*



- **If messages are registered beyond the registration setting range of messages, the project comparison tool will not operate properly.**

#### ◆ Message Color

Designates message’s color. Select the display color (Fg) and background color (Bg), and specify whether to blinking (Blk) is used or not.

#### ◆ Automatic Address Increment

After entering and registering a message in a line and moving to the next line, an address that is one bit larger will be automatically entered for the new line.



**When a variable (GLC symbol) is used as an address, the automatic address increment function must be turned off. Otherwise, the correct address number addition will not be performed.**

◆ **Jump to the designated line.**

Specify a line and click  to jump to the line.

◆ **Print (at alarm trigger/recovery)**

An Alarm Message (like a bulletin board) can be printed out when the alarm is triggered and when recovered. Specify if the Alarm Message is printed out at the triggering of the alarm and at the recovery from the alarm, respectively. When [Summary] is selected, this setting becomes ineffective.



**This function is supported only by GPs with a printer interface.**

Trigger Time: Prints out the time when the Alarm Message started.

Recovery Time: Prints out the time when the Alarm Message is finished.

**Printing Example**

Trigger	10/15	16:07	No.1 error
Recovery	10/15	16:30	No.1 error
Trigger	10/21	11:25	No.1 error
Trigger	10/21	11:28	No.3 error
Recovery	10/21	15:45	No.1 error



- ***The GP can store up to 1000 pieces of print information from Alarm Message (like a bulletin board) triggering and recovery events. When the GP is not connected to a printer, up to 1000 events will be stored in the GP, which enters a printing standby mode. When the number of events exceeds 1000, new events will not be stored.***
- ***When a printer changes to offline mode due to a lack of paper, DO NOT turn the GP's power OFF. Refill the paper and return the printer to online mode. Event information stored in the GP in the printer offline mode will be output to the printer when the printer mode returns to online.***
- ***If the printer's power is turned OFF during printing, event information transferred from the GP to the printer while the printer's power is OFF will not be printed.***

### ■ Bit Log Alarm

This screen is used to register messages to be displayed in an “Alarm Summary” (specified by a “Q-Tag”). The maximum number of messages for both the Bit Log Alarm and Word Log Alarm which can be registered in the Alarm Editor varies depending on the GP type.

GP type	Maximum Number of Messages
GP-270, GP-H70, GP-370	512
Other GP70 series and GP77R series	768
GP2000 series	2048 <sup>*1</sup>

\*1 The 769th message and thereafter cannot be registered with Word Log Alarm.

Note that the total number of alarms that can be stored in the GP (both Bit Log Alarms and Word Log Alarms) is 768.

**Reference** Tag Reference Manual, 2.20.9 ◆ Q-tag Setting

When selected/enabled, Block tabs will appear for Blocks 1 to 8. Select each block's Alarm Display type from the pull down menu and register the Bit Alarm.

When selected/enabled, extended Q-tag features such as Alarm Count, Accumulated Time, Alarm Message Level and other settings will appear in each of the Block Tabs, up to Block 8. This option is available only on GP2000 Series units.

The screenshot shows the 'Bit Alarm Log Settings - Plant 1.prw' window. It includes a menu bar (Alarm, Edit, View, Help), a toolbar, and several control areas. A pull-down menu is set to 'Active'. Below it are 'Block1' through 'Block8' tabs. A table at the bottom has columns for 'Bit Address', 'Group No.', 'Sub Display', 'State', and 'Level'. The 'State' column shows 'off' for rows 1-5. The 'Level' column is empty. A status bar at the bottom shows 'Ready' and a 'NUM' indicator.

**Address Keypad**: Located at the top left of the main settings area.

**Specify whether or not the automatic address increment function is used.**: Points to the 'Automatic Address Increment' checkbox.

**Select the Alarm Message's text.**: Points to the 'Direct', 'Browse Text Table', and 'Set' options.

**Jumps to the specified line.**: Points to the 'Jump' button and the '10----' input field.

**Pull down menu (Active/ History/ Log)**: Points to the 'Active' dropdown menu.

**Block tabs**: Points to the 'Block1' through 'Block8' tabs.

**Bit Address**: Points to the first column of the table.

**Group Number**: Points to the second column of the table.

**Sub Display**: Points to the third column of the table.

**State**: Points to the fourth column of the table.

**Level data is displayed when [Use Extended Features] is checked.**: Points to the fifth column of the table.

### ◆ Use Blocks

When selected/enabled, the attributes [Active], [History] and [Log] are created.

Use the block tab's pull down menu to select either of these items. Up to 3 blocks can be set.



- **Block settings are available only on GP-377, GP77R, and GP2000 Series units.**



Selecting/enabling [Use Extended Features] allows you to set up to 8 blocks.

- **Only GP2000 units can use the [Use Extended Features] setting.**

### ◆ Use Extended Features

Bit/Word Log Alarms use the Q-tag.

When selected, Q-tag extended features can be selected. To use these extended features, click the Tool bar's  (System Setting) icon and use the Q-tag dialog box to enter the settings.



- **Q-tag extended features are available only on GP2000 Series units.**



- **When [Use Extended Features] is checked and the Alarm Editor setting is saved, the extended function cannot be canceled (disabled/unchecked). In order to simultaneously extend data features, currently selected project files cannot be opened when using GP-PRO/PBIII for Windows Ver. 6.3 or earlier.**

**The alarm dialog below appears before the Alarm Editor setting is saved or closed. If you want to use the extended function, click . If you want to disable the function, click  and remove the checkmark.**

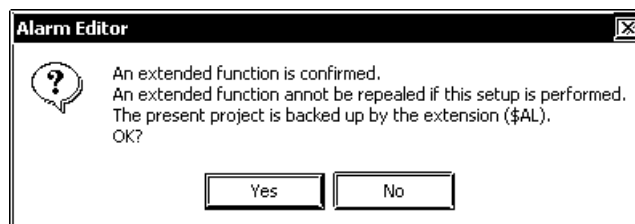

**Clicking on  will create a .\$AL file in the currently selected project file's folder. To restore the file to its original version, simply change the suffix of the file from .\$AL to .prw.**

The Q-tag alarm feature has been expanded to include the following:

- (1) Up to 8 blocks can be used for alarms.
- (2) Can display accumulated count data for Q-tag alarm occurrences, as well as occurrence times.
- (3) Colors and levels (0 to 7 - total of 8) can now be set for alarm messages.
- (4) Alarm contents can now be sorted.

Ex.) Order can be set for Occurrence Time, Occurrence Frequency, Levels or Dates.

**Reference** *Tag Reference Manual 2.23.3 Setting Items ■ Operation Mode/Special*

- (5) When a Q-tag Alarm's cursor position (address) is designated, pushing the [Alarm Acknowledge Key (use T-tag)] will write to the designated address, using the alarm's registration code. (Set via the Alarm Editor) Also, if the [Notify ID at each cursor movement.] is enabled, the currently selected Alarm's registration number will be written to the designated address, without pressing the Alarm Acknowledge key. For Alarm Acknowledge Key details, **Reference** *Tag Reference Manual 2.23.3 Setting Items ■ Operation Mode/Special*
- (6) The Q-tag Alarm Occurrence Frequency and Accumulated Time data is cleared from via either the Device PLC's control command or a D-Script command.

**Reference** *Tag Reference Manual 2.20 Q-tag (Alarm Summary bit log/word log Display) Extended Feature*

#### ◆ Direct Text

Allows you to directly enter message text. Up to 100 characters can be entered, however the actual number of displayable characters will depend on the GP model used.

#### ◆ Browse Text Table

Text registered in the Text Table Editor can be called up and replace other message text.

For setup details, **Reference** *4.6.3 Screen Editor Settings ◆ Alarm Editor Message Settings*



- Multi-language Display Feature is supported by GP-377/GP77R/ GP2000 Series units.
- When designating “Browse Text Table”, Alarm Import/Export feature cannot be used.

#### ◆ Automatic Address Increment

After entering and registering a message in a line and moving to the next line, an address that is one bit larger will be automatically entered for the new line.



- **When a variable (GLC symbol) is used as an address, the automatic address increment function must be turned off. Otherwise, correct address number addition will not be performed.**

◆ **Address Keypad**

An address keypad is displayed, that allows you to enter the bit address using a mouse.

◆ **Bit Address**

Enter the bit address used for monitoring. Specify the bit address so that the monitor bit (Bit Log Alarm combined with the Word Log Alarm) does not exceed 256 words.

◆ **Group No.**

Enter a group number for counting alarms.

The counting of alarms with the same group number will be stored in the same LS area. LS areas are automatically reserved, for as many group numbers as have been specified. Bit log alarms and word log alarms with the same group number are counted as the same group.

In order to set up the area in which the number of alarm occurrences is written, select [GP Setup] from the Project Manager. Select [Triggered Alarm Count Address] from the [Q-Tag Settings] menu on the [Extended Features] tab.



• Select [System Settings] from the [Alarm] menu on the Alarm Editor screen, or click  to enter the "Q-Tag Settings" dialog box.

◆ **Sub Display**

To perform sub-display with a Q-tag, specify here a desired sub-display screen number corresponding to each message and the same number as a window registration number. These numbers may be from 0 to 8999.

Example 1: To sub-display the screen "B2", enter 2.

Example 2: If no sub-display is required, enter 0 (default value is 0).

◆ **State**

Specify the monitor bit status (ON/OFF) that activates the alarm output.

◆ **Message**

Enter your Message text here. When using Direct Text, a single message can be up to 100 characters, however the actual number of characters that can be displayed will depend on your GP model.

With the GP-377, GP77R and GP2000 series, selecting the [Browse Text Table] feature allows you to use the text registered in the Text Table Editor to change message text. **Reference** 4.6.3 **Selecting Alarm Editor Messages**

◆ **Level**

This feature sets the Alarm Message's Level. Levels 0 to 7 can be used for a total of 8 levels. Use this feature to assign lower levels to less important messages and higher levels to more important messages. Initial level setting is "0".

Colors can also be assigned to each level and displayed on the GP. For setting information, **Reference** Tag Reference Manual 2.20.4 Setting Items

■ **Size/Color**



• The level can be set when the [Use Extended Features] check box is checked (enabled). This option is available only on the GP2000 Series units.

■ **Word Alarm Log**

This screen is used to register messages displayed in an “Alarm Summary” (specified by a “Q-Tag”). The maximum number of messages for both the Bit Log Alarm and Word Log Alarm which can be registered in the Alarm Editor varies depending on the GP type.

GP type	Maximum Number of Messages
GP-270, GP-H70, GP-370	512
Other GP70 series and GP77R series	768
GP2000 series	2048* <sup>1</sup>

\*1 The 769th message and thereafter cannot be registered with Word Log Alarm.

Note that the total number of alarms that can be stored in the GP (both Bit Log Alarms and Word Log Alarms) is 768.

▼ **Reference** ▲ Tag Reference Manual, 2.20.9 ◆ **Q-tag Setting**

**When selected/enabled, Block tabs will appear for Blocks 1 to 8. Select each block's Alarm Display type from the pull down menu and register the Word Alarm.**

**When selected/enabled, extended Q-tag features such as Alarm Count, Accumulated Time, Alarm Message Level and other settings will appear in each of the Block Tabs, up to Block 8.**

**Specify whether or not the automatic address increment function is used.**

**Address Keypad**

**Pull down menu (Active/ History/ Log)**

**Block setting**

**Word Address** **Group Number** **Alarm Value** **Sub Display** **Monitor Bit**

**Go to the specified line.**

**Select the Alarm Message's text.**

**Message**

**Level information is displayed only when [Use Extended Features] is checked.**

**Alarm Value Data Format**

**Use block** **Data Format** **Dec**

**Use extended features**

**Automatic Address Increment** **Jumps to the designated line** **1** **Jump**

**Direct** **Browse Text Table** **Set**

**10----**

**Block1** **Block2** **Block3** **Block4** **Block5** **Block6** **Block7** **Block8**

**Word, A...** **Group No.** **Sub Di...** **Ala...** **Bit** **Level** **Message/Summa**

**1** **2** **3** **4** **5** **6** **7**

**Ready** **Print**

◆ **Use Blocks**

When selected/enabled, the attributes [Active], [Log] and [History] are created. Use the block tab's pull down menu to select either of these items. Up to 3 blocks can be set.



• Block settings are available only on GP-377, GP77R, and GP2000 Series units.

Selecting/enabling [Use Extended Features] allows you to set up to 8 blocks.



• Only GP2000 units can use the [Use Extended Features] setting.



### ◆ Use Extended Features

Bit/Word Log Alarms use the Q-tag.

When selected, Q-tag extended features can be set. To use these extended features, click the Tool bar's  (System Setting) icon and use the Q-tag dialog box to enter the settings.



- Q-tag extended features are available only on GP2000 Series units.



- **When [Use Extended Features] is checked and the Alarm Editor setting is saved, the extended function cannot be canceled (disabled/unchecked). In order to simultaneously extend data features, currently selected project files cannot be opened when using GP-PRO/PBIII for Windows Ver. 6.3 or earlier.**

**The alarm dialog below appears before the Alarm Editor setting is saved or closed. If you want to use the extended function, click . If you want to disable the function, click  and remove the checkmark.**

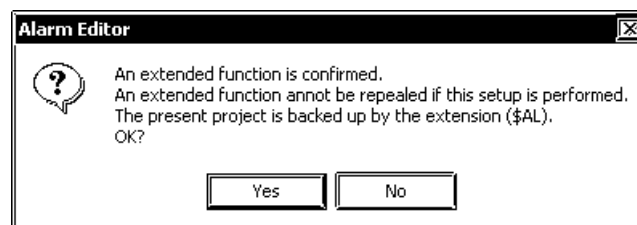

**Clicking on  will create a .\$AL file in the currently selected project file's folder. To restore the file to its original version, simply change the suffix of the file from .\$AL to .prw and move it to a different folder.**

The Q-tag alarm feature has been expanded to include the following:

- (1) Up to 8 blocks can be used for alarms.
- (2) Can display accumulated count data for Q-tag alarm occurrences, as well as occurrence times.
- (3) Colors and levels (0 to 7 - total of 8) can now be set for alarm messages.
- (4) Alarm contents can now be sorted.  
Ex. Order can be set for Occurrence Time, Occurrence Frequency, Levels or Dates.

**▼Reference▲ Tag Reference Manual 2.23.3 Setting Items ■ Operation Mode/Special**

- (5) When a Q-tag Alarm's cursor position (address) is designated, pushing the [Alarm Acknowledge Key (use T-tag)] will write to the designated address, using the alarm's registration code. (Set via the Alarm Editor) Also, if the [Notify ID at each cursor movement.] is enabled, the currently selected Alarm's registration number will be written to the designated address, without pressing the Alarm Acknowledge key. For Alarm Acknowledge Key details, **▼Reference▲ Tag Reference Manual 2.23.3 Setting Items ■ Operation Mode/Special**

(6)The Q-tag Alarm Occurrence Frequency and Accumulated Time data is cleared via either the Device PLC's control command or a D-Script command.

**▼Reference▲** *Tag Reference Manual 2.20 Q-tag (Alarm Summary bit log/word log Display) Extended Feature*

#### ◆ Direct Text

Allows you to directly enter message text. Up to 100 characters can be entered, however the actual number of displayable characters will depend on the GP model used.

#### ◆ Browse Text Table

Text registered in the Text Table Editor can be called up and used to replace other message text.

For setup details, **▼Reference▲** *4.6.3 Screen Editor Settings* ◆ *Alarm Editor Message Settings*



- The text registered in the Text Table Editor can be used only on the GP377, GP77R and GP2000 Series units.
- When designating “Browse Text Table”, Alarm Import/Export feature cannot be used.

#### ◆ Automatic address increment

After entering and registering a message in a line and moving to the next line, an address that is one bit larger is automatically entered for the new line.



- **When a variable (GLC symbol) is used as an address, the automatic address increment function must be turned off. Otherwise, the correct address number addition will not be performed.**

#### ◆ Address Keypad

Clicking here displays a address keypad, allowing you to enter bit address data using your mouse.

#### ◆ Alarm Value Data Format

Selects the alarm value's data format.

#### ◆ Word Address

Set up a word address. Specify the bit address so that the monitor bit (Bit Log Alarm combined with the Word Log Alarm) does not exceed 256 words.

◆ **Group No.**

Enter a group number for counting alarms.

The counting of alarms with the same group number will be stored in the same LS area. LS areas are automatically reserved, for as many group numbers as have been specified. Bit log alarms and word log alarms with the same group number are counted as the same group.

In order to set up the area in which the number of alarm occurrences is written, select [GP System Setup] of the Project Manager. Select [Triggered Alarm Count Address] from the [Q-Tag Settings] menu on the [Extended Feature Settings] tab.



• Select [System Settings] from the [Alarm] menu on the Alarm Editor screen, or click  to enter the "Q-Tag Settings" dialog box.

◆ **Sub Display**

To perform sub-display with a Q-tag, specify here a desired sub-display screen number corresponding to each message and the same number as a window registration number. These number may be entered in a range between 0 and 8999.

Example 1: To sub-display a screen of B2, enter 2.

Example 2: If no sub-display is required, enter 0 (default value is 0).

◆ **Alarm Value**

Specify the limit value of the monitor word used to activate the alarm's output.

◆ **Monitor Bit**

Select "16 bits" for single-word monitoring, or "32 bits" for two-word monitoring.

◆ **Message**

Enter your Message text here. When using Direct Text, a single message can be up to 100 characters, however the actual number of characters that can be displayed will depend on your GP model.

With the GP-377, GP77R and GP2000 series, selecting the [Browse Text Table] feature allows you to use the text registered in the Text Table Editor to change message text. **▼ Reference ▲ 4.6.3 ◆ Selecting Alarm Editor Messages**

◆ **Level**

This feature sets the Alarm Message's Level. Levels 0 to 7 can be used for a total of 8 levels. Use this feature to assign lower levels to less important messages and higher levels to more important messages. Initial level setting is "0".









Colors can also be assigned to each level and displayed on the GP. For detailed setting information, **▼ Reference ▲ Tag Reference Manual 2.20.4 Setting Items ■ Size/Color**



• The level can be set when the [Use Extended Features] check box is checked (enabled). This option is available only on GP2000 Series units.

## ■ Editing Tools

The Alarm Editor has the following editing features.

Icon	Editing Tool	Description
	Cut	Used to delete a symbol's line of data and store it on the clipboard. The [Paste] command allows you to then move that symbol to another line.
	Copy	Used to copy a selected line of data to the clipboard.* <sup>1</sup>
	Paste	Used to insert the line of data temporarily stored on the clipboard into the desired row, after the Cut/Copy command has been performed.
	Undo	Used to cancel the command previously performed and return to the previous condition. However, an edited symbol character cannot be restored.
	Add Alarm	Adds an address. If the selected alarm number already exists, that data can be overwritten.
	Change Attribute	Allows you to change the alarm attributes.
	Apply Device Comment	Inputs device comments for all the selected devices in the Message Column.
	System Settings	Allows you to go to the "Q-tag Settings" dialog box from the "Alarm Editor". Press the [OK] button to save the settings for the Q-tag.

---

*\*1 When the [Copy] or [Cut] command is executed, the copied or deleted data is temporarily stored on the clipboard. When you execute the [Paste] command, the data stored on the clipboard can be copied or moved to a desired position.*

**5.1.2 Creating an Alarm**

This section describes how to create and register alarm messages using Alarm Editor. (When using the Alarm Editor on the [Alarm Message/Alarm Summary Settings])

PROCEDURE	REMARKS
-----------	---------

(1) Via the Project Manager, select the [Screen/Setting] menu - [Alarm Editor] command, or click on the



icon to open the Alarm Editor.

Refer to "5.1.1 Alarm Editor" and select the desired alarm type.

Select the alarm type.

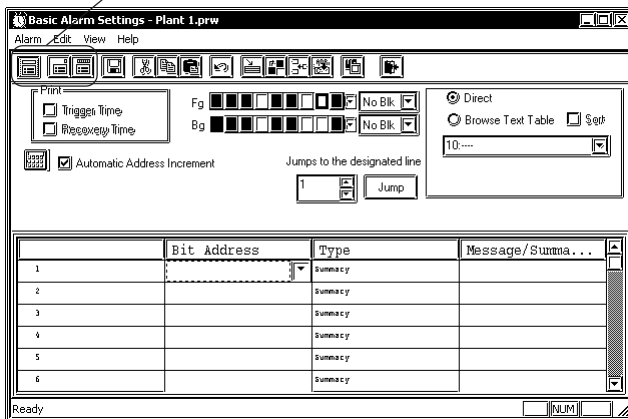

(2) Specify the bit address (monitor bit).



(3) Enter a message.

Enter the message to be displayed on the GP unit panel during alarm output.

Select a message color, if desired.

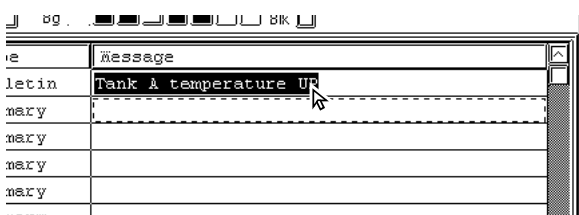



Entering data in the Alarm Editor only does not activate the "Alarm Summary" mode. To activate the "Alarm Summary" mode, you must set up an "a-Tag" for the Base screen where the message is displayed.

When designating an Alarm summary's bit address, be sure to select a device that can use word designated units.

**Reference** *Device/PLC Connection Manual, Chapters 2 & 5 - each item's section 3 - Supported Devices*

Up to 160 alphanumeric characters can be entered for one Basic Alarm message.

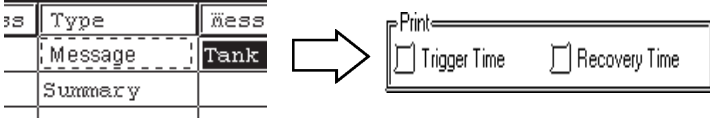
After selecting several messages by dragging the mouse, you can use the [Copy] and [Paste] commands.



PROCEDURE	REMARKS
<p><b>(4) Select the alarm type: Alarm “Message” or Alarm “Summary”.</b>                      If you select “Message”, you can also designate the alarm trigger/recovery time history print command.</p>  <p><b>(5) After entering all the necessary items, select the [Alarm] menu - [Save] command, or click on the  icon.</b>                      The specified alarm data will be stored in the currently opened project file.</p>	<p>Up to 512 alarm messages can be registered. However, set the monitor bits within 128 words.</p> <p>Alarm messages can be printed with GP-470, GP-571T, GP-675, GP-870, GP77R and GP2000 (except GP2000H) series. To perform printing with GP-377R, GP-2301, however, a Multi Unit (sold separately) will be needed.</p> <p>If a message has not been entered, the Alarm Editor data cannot be saved, even if the bit addresses have been specified.</p>

**5.1.3 Editing Alarm Data**

This section describes how to use the Alarm Editor’s editing commands.

**■ Cut/Move**

Here, you can delete the selected line of alarm data and store it on the clipboard.

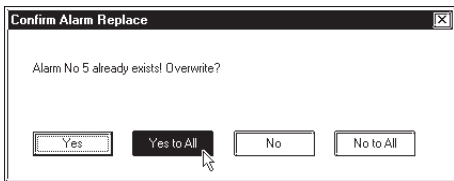

PROCEDURE	REMARKS																																																																						
<p><b>(1) Select the line of alarm data to be moved.</b></p> <table border="1"> <tr><td>1</td><td>X0010</td><td>Bulletin</td><td>Tank A temperature UP</td></tr> <tr><td>2</td><td>X0050</td><td>Summary</td><td>Tank B temperature UP</td></tr> <tr><td>3</td><td>X0051</td><td>Summary</td><td>Tank C temperature UP</td></tr> <tr><td>4</td><td>X0052</td><td>Summary</td><td></td></tr> </table> <p><b>(2) Select the [Edit] menu - [Cut] command, or click on the  icon to import alarm data to the Clipboard.</b> The selected alarm data will be deleted and stored.</p> <table border="1"> <thead> <tr><th>Bit Address</th><th>Type</th><th>Message</th></tr> </thead> <tbody> <tr><td>1</td><td>X0010</td><td>Bulletin</td><td>Tank A temperature UP</td></tr> <tr><td>2</td><td>X0050</td><td>Summary</td><td>Tank B temperature UP</td></tr> <tr><td>3</td><td></td><td>Summary</td><td></td></tr> <tr><td>4</td><td>X0052</td><td>Summary</td><td></td></tr> <tr><td>5</td><td>X0053</td><td>Summary</td><td></td></tr> </tbody> </table> <p><b>(3) Select the insertion line.</b></p> <table border="1"> <thead> <tr><th>Bit Address</th><th>Type</th><th>Message</th></tr> </thead> <tbody> <tr><td>1</td><td>X0010</td><td>Bulletin</td><td>Tank A temperature UP</td></tr> <tr><td>2</td><td>X0050</td><td>Summary</td><td>Tank B temperature UP</td></tr> <tr><td>3</td><td></td><td>Summary</td><td></td></tr> <tr><td>4</td><td>X0052</td><td>Summary</td><td></td></tr> <tr><td>5</td><td>X0053</td><td>Summary</td><td></td></tr> <tr><td>6</td><td>X0054</td><td>Summary</td><td></td></tr> <tr><td>7</td><td>X0055</td><td>Summary</td><td></td></tr> </tbody> </table> <p><b>(4) Select the [Edit] menu - [Paste] command, or click on the  icon to paste alarm data to the destination from the Clipboard.</b> If the same number already exists, the system asks if each file must be overwritten. If you select <input type="button" value="Yes"/>, the desired data will be overwritten. If you select <input type="button" value="No"/>, the desired file will not be overwritten, and the system will ask the same question for the next alarm. If you select <input type="button" value="Yes to All"/>, all existing alarms will be overwritten. If you select <input type="button" value="No to All"/>, you will return to the menu screen.</p>	1	X0010	Bulletin	Tank A temperature UP	2	X0050	Summary	Tank B temperature UP	3	X0051	Summary	Tank C temperature UP	4	X0052	Summary		Bit Address	Type	Message	1	X0010	Bulletin	Tank A temperature UP	2	X0050	Summary	Tank B temperature UP	3		Summary		4	X0052	Summary		5	X0053	Summary		Bit Address	Type	Message	1	X0010	Bulletin	Tank A temperature UP	2	X0050	Summary	Tank B temperature UP	3		Summary		4	X0052	Summary		5	X0053	Summary		6	X0054	Summary		7	X0055	Summary		<p>If a message has not been entered, Alarm Editor data cannot be saved, even if bit addresses have been specified.</p> <p>To select several lines, drag the mouse between the target lines, or click on the target line while holding down the Shift or Ctrl key.</p> <p>To delete the selected line(s), perform steps (1) and (2) only.</p>
1	X0010	Bulletin	Tank A temperature UP																																																																				
2	X0050	Summary	Tank B temperature UP																																																																				
3	X0051	Summary	Tank C temperature UP																																																																				
4	X0052	Summary																																																																					
Bit Address	Type	Message																																																																					
1	X0010	Bulletin	Tank A temperature UP																																																																				
2	X0050	Summary	Tank B temperature UP																																																																				
3		Summary																																																																					
4	X0052	Summary																																																																					
5	X0053	Summary																																																																					
Bit Address	Type	Message																																																																					
1	X0010	Bulletin	Tank A temperature UP																																																																				
2	X0050	Summary	Tank B temperature UP																																																																				
3		Summary																																																																					
4	X0052	Summary																																																																					
5	X0053	Summary																																																																					
6	X0054	Summary																																																																					
7	X0055	Summary																																																																					

PROCEDURE	REMARKS																																
<div style="border: 1px solid black; padding: 5px; margin-bottom: 10px;"> <p><b>Confirm Alarm Replace</b> [X]</p> <p>Alarm No 5 already exists! Overwrite?</p> <p> <input type="button" value="Yes"/> <input checked="" type="button" value="Yes to All"/> <input type="button" value="No"/> <input type="button" value="No to All"/> </p> </div> <div style="text-align: center; margin-bottom: 10px;">  </div> <p>The selected alarm data is moved to the specified line.</p> <table border="1" style="width: 100%; border-collapse: collapse;"> <thead> <tr> <th></th> <th>Bit Address</th> <th>Type</th> <th>Message</th> </tr> </thead> <tbody> <tr> <td>1</td> <td>X0010</td> <td>Summary</td> <td>Tank A stops</td> </tr> <tr> <td>2</td> <td>X0050</td> <td>Summary</td> <td>Tank B stops</td> </tr> <tr> <td>3</td> <td></td> <td>Summary</td> <td></td> </tr> <tr> <td>4</td> <td>X0052</td> <td>Summary</td> <td></td> </tr> <tr> <td>5</td> <td>X0051</td> <td>Summary</td> <td>Tank C stops</td> </tr> <tr> <td>6</td> <td>X0054</td> <td>Summary</td> <td></td> </tr> <tr> <td>7</td> <td>X0055</td> <td>Summary</td> <td></td> </tr> </tbody> </table>		Bit Address	Type	Message	1	X0010	Summary	Tank A stops	2	X0050	Summary	Tank B stops	3		Summary		4	X0052	Summary		5	X0051	Summary	Tank C stops	6	X0054	Summary		7	X0055	Summary		
	Bit Address	Type	Message																														
1	X0010	Summary	Tank A stops																														
2	X0050	Summary	Tank B stops																														
3		Summary																															
4	X0052	Summary																															
5	X0051	Summary	Tank C stops																														
6	X0054	Summary																															
7	X0055	Summary																															



## ■ Copy

Copies the selected line of alarm data, and stores it on the clipboard.

PROCEDURE	REMARKS																																																																																								
<p><b>(1) Select the alarm line to be copied.</b></p> <table border="1"> <thead> <tr> <th></th> <th>Bit Address</th> <th>Type</th> <th>Message</th> </tr> </thead> <tbody> <tr> <td>1</td> <td>X00010</td> <td>Bulletin</td> <td>Tank A temperature UP</td> </tr> <tr> <td>2</td> <td>X00050</td> <td>Summary</td> <td>Tank B temperature UP</td> </tr> <tr style="background-color: #cccccc;"> <td>3</td> <td>X00051</td> <td>Summary</td> <td>Tank C temperature UP</td> </tr> <tr> <td>4</td> <td>X00052</td> <td>Summary</td> <td></td> </tr> <tr> <td>5</td> <td>X00053</td> <td>Summary</td> <td></td> </tr> </tbody> </table> <p><b>(2) Select the [Edit] menu - [Copy] command, or click on the  icon to import alarm data to the Clipboard.</b> The selected alarm data will be copied to the clipboard.</p> <table border="1"> <thead> <tr> <th></th> <th>Bit Address</th> <th>Type</th> <th>Message</th> </tr> </thead> <tbody> <tr> <td>1</td> <td>X00010</td> <td>Summary</td> <td>Tank A temperature UP</td> </tr> <tr> <td>2</td> <td>X00050</td> <td>Summary</td> <td>Tank B temperature UP</td> </tr> <tr> <td>3</td> <td>X00051</td> <td>Bulletin</td> <td>Tank C temperature UP</td> </tr> <tr> <td>4</td> <td>X00052</td> <td>Summary</td> <td></td> </tr> <tr> <td>5</td> <td>X00051</td> <td>Bulletin</td> <td></td> </tr> </tbody> </table> <p><b>(3) Select the destination line.</b></p> <table border="1"> <thead> <tr> <th></th> <th>Bit Address</th> <th>Type</th> <th>Message</th> </tr> </thead> <tbody> <tr> <td>1</td> <td>X00010</td> <td>Summary</td> <td>Tank A temperature UP</td> </tr> <tr> <td>2</td> <td>X00050</td> <td>Summary</td> <td>Tank B temperature UP</td> </tr> <tr> <td>3</td> <td>X00051</td> <td>Bulletin</td> <td>Tank C temperature UP</td> </tr> <tr> <td>4</td> <td>X00052</td> <td>Summary</td> <td></td> </tr> <tr> <td>5</td> <td>X00051</td> <td>Bulletin</td> <td></td> </tr> <tr> <td>6</td> <td>X00054</td> <td>Summary</td> <td></td> </tr> <tr style="background-color: #cccccc;"> <td>7</td> <td>X00055</td> <td>Summary</td> <td></td> </tr> <tr> <td>8</td> <td>X00056</td> <td>Summary</td> <td></td> </tr> <tr> <td>9</td> <td>X00057</td> <td>Summary</td> <td></td> </tr> </tbody> </table> <p><b>(4) Select the [Edit] menu - [Paste] command, or click on the  icon to paste alarm data to the destination from the Clipboard.</b> If the same data already exists, the system asks if each file (item) must be overwritten. If you select <input type="button" value="Yes"/>, the desired file will be overwritten. If you select <input type="button" value="No"/>, the desired file will not be overwritten, and the system will ask the same question for the next alarm. If you select <input type="button" value="Yes to All"/>, all existing alarms will be overwritten. If you select <input type="button" value="No to All"/>, you will return to the menu screen.</p>		Bit Address	Type	Message	1	X00010	Bulletin	Tank A temperature UP	2	X00050	Summary	Tank B temperature UP	3	X00051	Summary	Tank C temperature UP	4	X00052	Summary		5	X00053	Summary			Bit Address	Type	Message	1	X00010	Summary	Tank A temperature UP	2	X00050	Summary	Tank B temperature UP	3	X00051	Bulletin	Tank C temperature UP	4	X00052	Summary		5	X00051	Bulletin			Bit Address	Type	Message	1	X00010	Summary	Tank A temperature UP	2	X00050	Summary	Tank B temperature UP	3	X00051	Bulletin	Tank C temperature UP	4	X00052	Summary		5	X00051	Bulletin		6	X00054	Summary		7	X00055	Summary		8	X00056	Summary		9	X00057	Summary		<p>Even if bit addresses have been specified, if message data has not been entered, the Alarm Editor data cannot be saved.</p> <p>To select several lines, drag the mouse between the target lines, or click on the target line while holding down the <input type="button" value="Shift"/> or <input type="button" value="Ctrl"/> key.</p>
	Bit Address	Type	Message																																																																																						
1	X00010	Bulletin	Tank A temperature UP																																																																																						
2	X00050	Summary	Tank B temperature UP																																																																																						
3	X00051	Summary	Tank C temperature UP																																																																																						
4	X00052	Summary																																																																																							
5	X00053	Summary																																																																																							
	Bit Address	Type	Message																																																																																						
1	X00010	Summary	Tank A temperature UP																																																																																						
2	X00050	Summary	Tank B temperature UP																																																																																						
3	X00051	Bulletin	Tank C temperature UP																																																																																						
4	X00052	Summary																																																																																							
5	X00051	Bulletin																																																																																							
	Bit Address	Type	Message																																																																																						
1	X00010	Summary	Tank A temperature UP																																																																																						
2	X00050	Summary	Tank B temperature UP																																																																																						
3	X00051	Bulletin	Tank C temperature UP																																																																																						
4	X00052	Summary																																																																																							
5	X00051	Bulletin																																																																																							
6	X00054	Summary																																																																																							
7	X00055	Summary																																																																																							
8	X00056	Summary																																																																																							
9	X00057	Summary																																																																																							

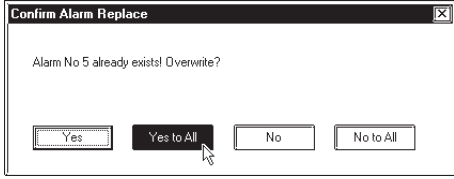
PROCEDURE	REMARKS																																												
 <p style="text-align: center;">↓</p> <p>The selected alarm data is copied to the specified line(s).</p> <table border="1" data-bbox="213 660 810 958"> <thead> <tr> <th></th> <th>Bit Address</th> <th>Type</th> <th>Message</th> </tr> </thead> <tbody> <tr><td>1</td><td>X0010</td><td>Bulletin</td><td>Tank A stops</td></tr> <tr><td>2</td><td>X0050</td><td>Summary</td><td>Tank B stops</td></tr> <tr><td>3</td><td>X0051</td><td>Summary</td><td>Tank C stops</td></tr> <tr><td>4</td><td>X0052</td><td>Summary</td><td></td></tr> <tr><td>5</td><td>X0053</td><td>Summary</td><td></td></tr> <tr><td>6</td><td>X0054</td><td>Summary</td><td></td></tr> <tr><td>7</td><td>X0051</td><td>Summary</td><td>Tank C stops</td></tr> <tr><td>8</td><td>X0056</td><td>Summary</td><td></td></tr> <tr><td>9</td><td>X0057</td><td>Summary</td><td></td></tr> <tr><td>10</td><td>X0058</td><td>Summary</td><td></td></tr> </tbody> </table>		Bit Address	Type	Message	1	X0010	Bulletin	Tank A stops	2	X0050	Summary	Tank B stops	3	X0051	Summary	Tank C stops	4	X0052	Summary		5	X0053	Summary		6	X0054	Summary		7	X0051	Summary	Tank C stops	8	X0056	Summary		9	X0057	Summary		10	X0058	Summary		<p>An alarm can be pasted onto alarms of different types. (For example, an alarm copied from "Alarm Message/Alarm Summary" can be pasted onto the "Bit Log Alarm".)</p> <p>Note that only the "message" will be pasted in this operation. Options other than the "message" must be set separately.</p>
	Bit Address	Type	Message																																										
1	X0010	Bulletin	Tank A stops																																										
2	X0050	Summary	Tank B stops																																										
3	X0051	Summary	Tank C stops																																										
4	X0052	Summary																																											
5	X0053	Summary																																											
6	X0054	Summary																																											
7	X0051	Summary	Tank C stops																																										
8	X0056	Summary																																											
9	X0057	Summary																																											
10	X0058	Summary																																											

■ **Undo**

This feature allows you to cancel the previously performed command, and return to the previous condition.

PROCEDURE	REMARKS																								
<p>When an alarm has been unintentionally deleted:</p> <p>(1) Select the [Edit] menu - [Undo] command, or click on the  icon.</p> <table border="1" data-bbox="213 1512 890 1697"> <thead> <tr> <th></th> <th>Bit Address</th> <th>Type</th> <th>Message</th> </tr> </thead> <tbody> <tr><td>1</td><td>X00010</td><td>Bulletin</td><td>Tank A temperature UP</td></tr> <tr><td>2</td><td>X00050</td><td>Summary</td><td>Tank B temperature UP</td></tr> <tr><td>3</td><td>X00051</td><td>Summary</td><td>Tank C temperature UP</td></tr> <tr><td>4</td><td>X00052</td><td>Summary</td><td></td></tr> <tr><td>5</td><td>X00053</td><td>Summary</td><td></td></tr> </tbody> </table>		Bit Address	Type	Message	1	X00010	Bulletin	Tank A temperature UP	2	X00050	Summary	Tank B temperature UP	3	X00051	Summary	Tank C temperature UP	4	X00052	Summary		5	X00053	Summary		<p>Edited message characters cannot be restored with the [Undo] command.</p>
	Bit Address	Type	Message																						
1	X00010	Bulletin	Tank A temperature UP																						
2	X00050	Summary	Tank B temperature UP																						
3	X00051	Summary	Tank C temperature UP																						
4	X00052	Summary																							
5	X00053	Summary																							

### ■ Adding Alarm Data

Here, you can add alarms for the specified number of bits or words from the line whose item is enclosed with dotted lines. Addresses are automatically assigned to each alarm from the start address in series, according to the designated address adding increment. In addition, when messages have been entered, they are copied for all the alarms to be added.

If an alarm number to be added already exists, a prompt will appear asking if the newly set data overwrites the old one.

The dialog box that appears will vary depending on the alarm type selected:



**When a variable (GLC symbol) is used as a start address, set the add offset to 0. Otherwise, the correct addition will not be performed.**

### ◆ Alarm Message/Summary

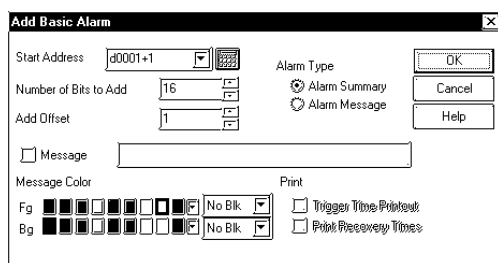

### ◆ Bit Alarm Log

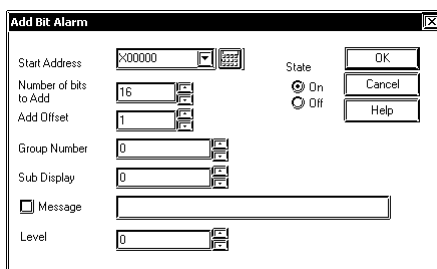

The [Level] setting can be selected only when the [Use Extended Features] check box is checked in the Alarm Editor.



• The [Use Extended Features] option is available only on GP2000 Series units.



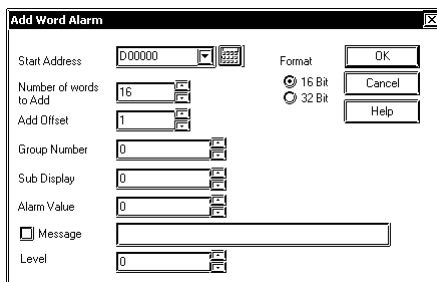







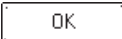

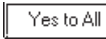
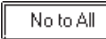
### ◆ Word Alarm Log



The [Level] setting can be selected only when the [Use Extended Features] check box is checked in the Alarm Editor.

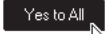
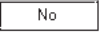
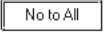

• The [Use Extended Features] option is available only on GP2000 Series units.

PROCEDURE	REMARKS																								
<p>(1) Select the address line where the specified number of addresses will be added. (Shown here with a dotted line around its border)</p> <table border="1" style="width: 100%; border-collapse: collapse;"> <thead> <tr> <th>Line</th> <th>Start Address</th> <th>Type</th> <th>Message</th> </tr> </thead> <tbody> <tr> <td>1</td> <td>X0010</td> <td>Bulletin</td> <td>Tank A Temperature UP</td> </tr> <tr style="border: 1px dotted black;"> <td>2</td> <td>X0001</td> <td>Summary</td> <td></td> </tr> <tr> <td>3</td> <td>X0002</td> <td>Summary</td> <td></td> </tr> <tr> <td>4</td> <td>X0003</td> <td>Summary</td> <td></td> </tr> <tr> <td>5</td> <td>X0004</td> <td>Summary</td> <td></td> </tr> </tbody> </table> <p>(2) Select the [Edit] menu - [Add Alarm] command, or click on the  icon.</p> <p>(3) After entering the necessary settings, click on the  button.</p> <p>If the same number already exists, the system asks if each file must be overwritten. If you select , the desired file will be overwritten. If you select , the desired file will not be overwritten, and the system will ask about the next alarm. If you select , all existing alarms will be overwritten. If you select , you will return to the menu screen.</p> <div style="border: 1px solid black; padding: 5px; margin-bottom: 10px;"> <p><b>Add Basic Alarm</b></p> <p>Start Address: d0001+1 </p> <p>Number of Bits to Add: 16 </p> <p>Add Offset: 1 </p> <p><input type="checkbox"/> Message</p> <p>Message Color: Fg  Bg </p> <p>Print: <input type="checkbox"/> Trigger Time Printed <input type="checkbox"/> Print Recovery Times</p> <p>Alarm Type: <input checked="" type="radio"/> Alarm Summary <input type="radio"/> Alarm Message</p> <p>  </p> </div> <div style="text-align: center; margin-bottom: 10px;">  </div> <div style="border: 1px solid black; padding: 5px;"> <p><b>Confirm Alarm Replace</b></p> <p>Alarm No 5 already exists! Overwrite?</p> <p>   </p> </div>	Line	Start Address	Type	Message	1	X0010	Bulletin	Tank A Temperature UP	2	X0001	Summary		3	X0002	Summary		4	X0003	Summary		5	X0004	Summary		<p>If a symbol is specified for the start address, the added addresses will be displayed as follows:</p> <p>Example: Assume that the start address is TEST (← Symbol), and that the number of added bits is 4. The addresses are consecutively added as shown below:</p> <pre>TEST TEST + 1 TEST + 2 TEST + 3</pre> <p>Set the address adding increment between 0 and 255.</p>
Line	Start Address	Type	Message																						
1	X0010	Bulletin	Tank A Temperature UP																						
2	X0001	Summary																							
3	X0002	Summary																							
4	X0003	Summary																							
5	X0004	Summary																							

■ **Changing Alarm Attributes**

You can easily change any alarm’s attributes. The dialog box that appears will vary depending on the alarm type selected.

◆ **Alarm Message/Summary**

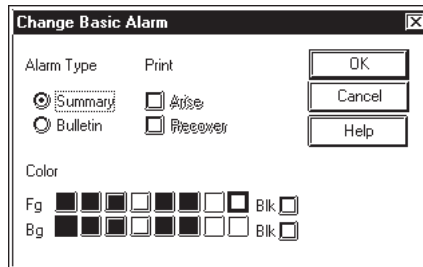

◆ **Bit Alarm Log**

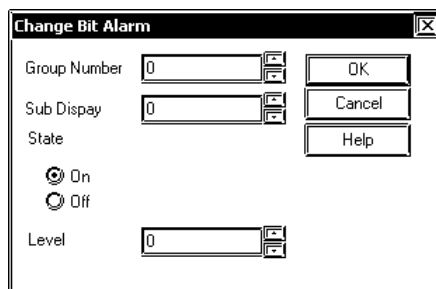

The [Level] setting can be selected only when the [Use Extended Features] check box is checked in the Alarm Editor.



• The [Use Extended Features] option is available only on GP2000 Series units.

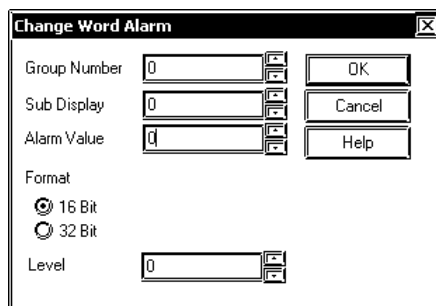

◆ **Word Alarm Log**



The [Level] setting can be selected only when the [Use Extended Features] check box is checked in the Alarm Editor.



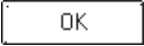
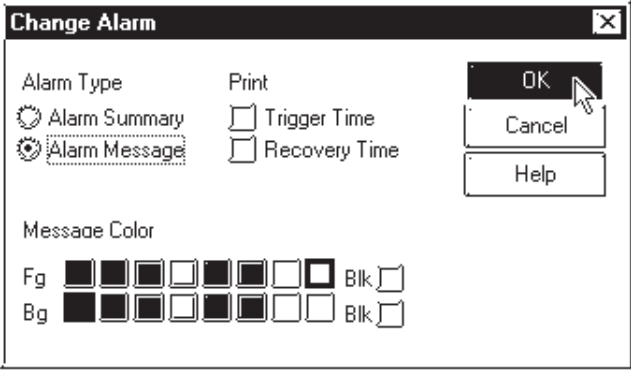

• The [Use Extended Features] option is available only on GP2000 Series units.

PROCEDURE	REMARKS																								
<p><b>(1) Select the line of the alarm to be changed.</b>                      In this example, we will change an attribute of an item in the alarm message/alarm summary area.</p> <table border="1"> <thead> <tr> <th></th> <th>Bit Address</th> <th>Type</th> <th>Message</th> </tr> </thead> <tbody> <tr> <td>1</td> <td>X00010</td> <td>Bulletin</td> <td>Tank A temperature UP</td> </tr> <tr> <td>2</td> <td>X00050</td> <td>Summary</td> <td>Tank B temperature UP</td> </tr> <tr> <td>3</td> <td>X00051</td> <td>Summary</td> <td>Tank C temperature UP</td> </tr> <tr> <td>4</td> <td>X00052</td> <td>Summary</td> <td></td> </tr> <tr> <td>5</td> <td>X00053</td> <td>Summary</td> <td></td> </tr> </tbody> </table> <p><b>(2) Select the [Edit] menu - [Change Attributes] command, or click on the  icon.</b></p> <p><b>(3) After entering the necessary items, click on the  button.</b></p> 		Bit Address	Type	Message	1	X00010	Bulletin	Tank A temperature UP	2	X00050	Summary	Tank B temperature UP	3	X00051	Summary	Tank C temperature UP	4	X00052	Summary		5	X00053	Summary		<p>If several lines are selected, the attributes of the selected lines can all be simultaneously changed.</p> <p>To select several lines, drag the mouse between the desired lines, or click on the desired line while pressing the  or  key.</p>
	Bit Address	Type	Message																						
1	X00010	Bulletin	Tank A temperature UP																						
2	X00050	Summary	Tank B temperature UP																						
3	X00051	Summary	Tank C temperature UP																						
4	X00052	Summary																							
5	X00053	Summary																							

■ **Reflecting Device Comments**

This feature is used to reflect all the comment information corresponding to a selected device in the Message field.

PROCEDURE	REMARKS																
<p>(1) <b>Select an alarm for which comment information is to be reflected, on a row basis.</b> Here, reflect the comment in the device for the alarm message/alarm summary.</p> <table border="1"> <thead> <tr> <th></th> <th>Bit Ad...</th> <th>Type</th> <th>Message/Summary Text</th> </tr> </thead> <tbody> <tr> <td>1</td> <td>X00100</td> <td>Summary</td> <td></td> </tr> <tr> <td>2</td> <td>X00101</td> <td>Summary</td> <td></td> </tr> <tr> <td>3</td> <td>X00102</td> <td>Summary</td> <td></td> </tr> </tbody> </table>		Bit Ad...	Type	Message/Summary Text	1	X00100	Summary		2	X00101	Summary		3	X00102	Summary		
	Bit Ad...	Type	Message/Summary Text														
1	X00100	Summary															
2	X00101	Summary															
3	X00102	Summary															
<p>(2) <b>Select the [Edit] menu - [Apply Device Comment] command, or click on the  icon.</b></p>																	
<p>(3) <b>A confirmation dialog box appears. Click on the <input type="button" value="Yes"/> button to execute the command</b></p> <div style="border: 1px solid black; padding: 5px; width: fit-content;"> <p><b>Alarm Editor</b> [X]</p> <p> The selected Address(es) will be used to search for a related Device Comment(s). If found, the comment will be inserted into message field. Are you OK?</p> <p><input type="button" value="Yes"/> <input type="button" value="No"/></p> </div>																	
<p>(4) <b>The device comment corresponding to the address will be included in the messages.</b></p> <table border="1"> <thead> <tr> <th></th> <th>Bit Ad...</th> <th>Type</th> <th>Message/Summary Text</th> </tr> </thead> <tbody> <tr> <td>1</td> <td>X00100</td> <td>Message</td> <td><b>E MACHINE STOPPED</b></td> </tr> <tr> <td>2</td> <td>X00101</td> <td>Summary</td> <td><b>E MACHINE STOPPED</b></td> </tr> <tr> <td>3</td> <td>X00102</td> <td>Summary</td> <td></td> </tr> </tbody> </table>		Bit Ad...	Type	Message/Summary Text	1	X00100	Message	<b>E MACHINE STOPPED</b>	2	X00101	Summary	<b>E MACHINE STOPPED</b>	3	X00102	Summary		
	Bit Ad...	Type	Message/Summary Text														
1	X00100	Message	<b>E MACHINE STOPPED</b>														
2	X00101	Summary	<b>E MACHINE STOPPED</b>														
3	X00102	Summary															

**5.1.4 Alarm Import/Export**

The created Alarm data can be exported to and saved as an ALA or CSV file. Then, by importing the saved alarm data, it can be shared among Projects. CSV files created via a text editor or Microsoft Excel can be imported and used on the Alarm Editor. Alarm data's CSV file formats are as follows:

"Block", "1"	<b>Block designation status</b>	
"Block1", "0"	<b>Block 1 attributes</b>	
"Block2", "1"	<b>Block 2 attributes</b>	
"Block3", "2"	<b>Block 3 attributes</b>	
"Basic Alarm"	<b>Message/Summary settings</b>	
"M0064", "Function A in suspension", "0", "0", "7", "0", "0", "0"		"Bit Address", "Message", "Printing status", "Type", "Fg", "Blk", "Bg", "Blk"
"M0065", "Function B in suspension", "1", "1", "1", "1", "2", "1"		
"M0066", "Function C in suspension", "2", "1", "3", "0", "5", "1"		
"Bit Log1"	<b>Bit log alarm Block 1 settings</b>	
"M0351", "Tank A: Abnormal pressure", "0", "0", "0", "0"		"Bit Address", "Message", "Group No.", "Sub-display Screen", "State", "Level" <sup>*1</sup>
"M0352", "Tank B: Abnormal pressure", "768", "8999", "1", "0"		
"Bit Log2"	<b>Bit log alarm Block 2 settings</b>	
"M0353", "Tank C: Abnormal pressure", "0", "0", "0", "0"		
"M0354", "Tank D: Abnormal pressure", "768", "8999", "1", "0"		
"Bit Log3"	<b>Bit log alarm Block 3 settings</b>	
"M0355", "Tank E: Abnormal pressure", "0", "0", "0", "0"		
"M0356", "Tank F: Abnormal pressure", "768", "8999", "1", "0"		
"Word Log1"	<b>Word log alarm: Block 1 settings</b>	
"R00101", "Tank A: Water level low", "0", "0", "0", "0", "0"		"Word Address", "Message", "Group No.", "Sub-display Screen", "Alarm Value", "Number of Monitor Bits", "Level" <sup>*1</sup>
"R00102", "Tank B: Water level low", "768", "8999", "65535", "1", "0"		
"Word Log2"	<b>Word log alarm: Block 2 settings</b>	
"R00103", "Tank C: Water level low", "0", "0", "0", "0", "0"		
"R00104", "Tank D: Water level low", "768", "8999", "65535", "1", "0"		
"Word Log3"	<b>Word log alarm: Block 3 settings</b>	
"R00105", "Tank E: Water level low", "0", "0", "0", "0", "0"		
"R00106", "Tank F: Water level low", "768", "8999", "65535", "1", "0"		

*\*1 This data is displayed when [Use Extended Features] is checked in the Alarm Editor. This function is available only on GP2000 Series units.*



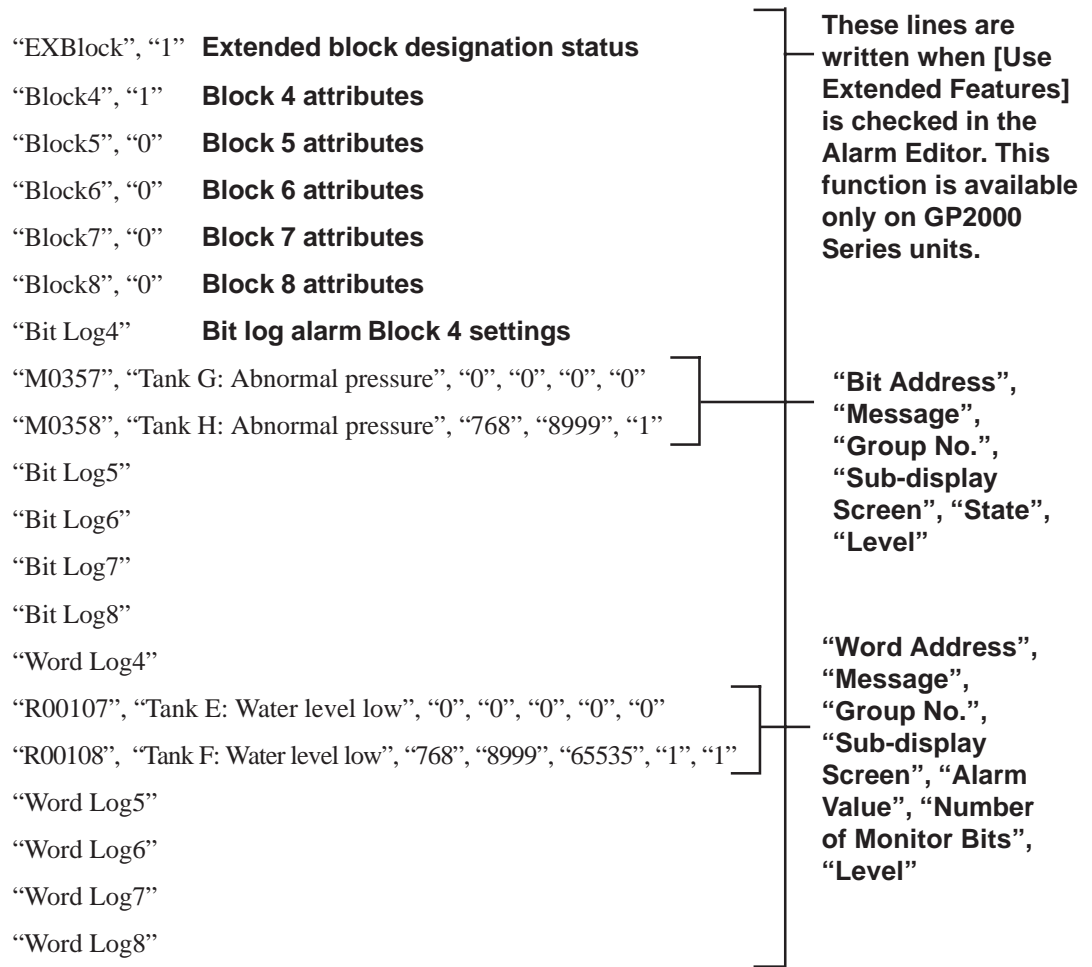



• CSV Import

GP Settings	Data	Operation
64-color	63 or less	Normal import
256-color	64 or more	Import with color setting: 0 to 255

• CSV Export

GP Settings	Data	Operation
64-color	63 or less	Normal export
256-color	64 or more	Export with blink setting: 0 to 255 Export with blink setting 0: Not blink

<b>Block Designation Status</b>	0: Specified 1: Not specified	
<b>Block Attributes</b>	0: Active 1: History 2: Log	
<b>Printing Status</b>	0: When Alarm is triggered, OFF/When recovered, OFF 1: When Alarm is triggered, ON/When recovered, OFF 2: When Alarm is triggered, OFF/When recovered, ON 3: When Alarm is triggered, ON/When recovered, ON	
<b>Message Colors</b>	Foreground color (Fg) Background color (Bg)	8-color compatible models: 0 to 7 64-color compatible models: 0 to 63 256-color compatible models: 0 to 255
	Blink (Blk)	Non-supporting model 0: Not blink 1: Blink 2: Not blink 3: Blink Supporting model 0: Not blink 1: Middle speed 2: High speed 3: Low speed
<b>Group No.</b>	0 to 768 (GP2000 series: 0 to 2012)	
<b>Sub-display Screen</b>	0 to 8999	
<b>Alarm Value</b>	Number of Monitor Bits: 16 : 0 to 65,535 Number of Monitor Bits: 32 : 0 to 4,294,967,295	
<b>Number of Monitor Bits</b>	0: 16 bits 1: 32 bits	

■ Alarm Export

Alarm data is saved as ALA or CSV files.

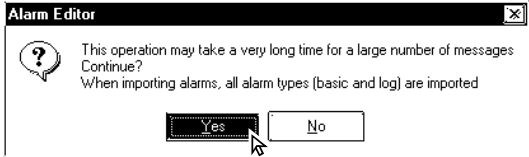
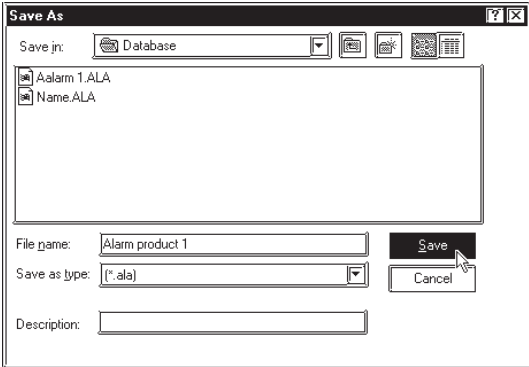
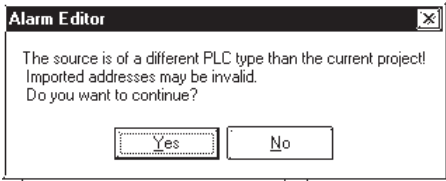
PROCEDURE	REMARKS
<p>(1) Select the Alarm Editor's [Alarm] menu - [Export] command.</p> <p>(2) Click on the <input type="button" value="Yes"/> button.</p>  <p>(3) Specify the file name and file type (*.ALA or *.CSV) with which the exported alarm data is saved, and click on the <input type="button" value="Save"/> button.</p> <p>Enter a comment, if desired.</p> <p>If the same ALA file name already exists, the system asks if the existing file must be overwritten. If it must be overwritten, select <input type="button" value="Yes"/>. If it should not be overwritten, select <input type="button" value="No"/>.</p>  <p style="text-align: center;">↓</p> 	<p>All the setting information of Alarm Message/Summary, Bit Log Alarm, and Word Log Alarm is saved in the exported file.</p>

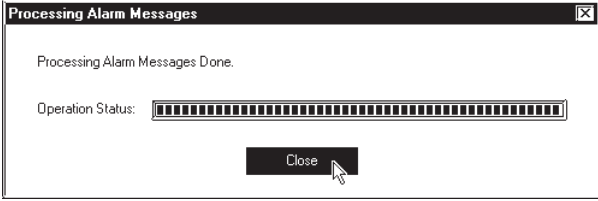
PROCEDURE	REMARKS
<p>(4) Click on the  button to quit the Alarm export mode.</p> 	

**■ Alarm Import**

Alarm data saved as a file is imported to the currently open Alarm Editor. Files with the extension of “\*.ALA” or “\*.CSV” can be imported.

To import alarm data from a CSV file, only the specified type of alarm can be imported from all the registered alarm.

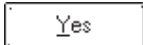
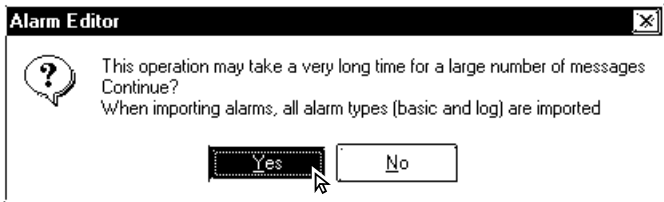
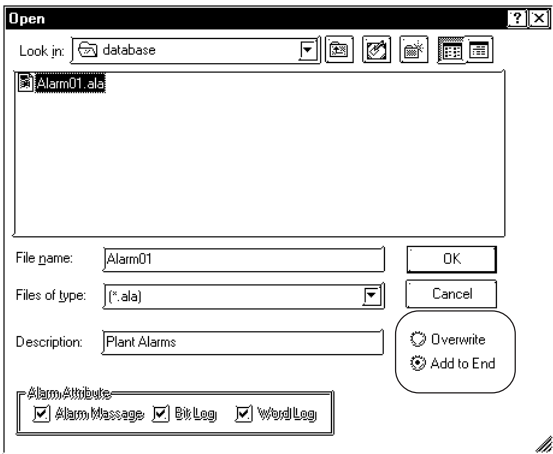
PROCEDURE	REMARKS
<p>(1) Select the Alarm Editor’s [Alarm] menu - [Import] command.</p> <p>(2) Click on the  button.</p>  <p>(3) Select a file (*.ALA or *.CSV) to be imported, or enter the file name. Then, specify an import method.</p> 	<p><b>[Overwrite]</b> All current alarm registration numbers (1 to 8999) will be overwritten.</p> <p><b>[Add to End]</b> Imported messages will be added after the last message line. If there are any gaps between the current registration numbers, the sequence numbers will be re-assigned to fit into all existing lines, and the imported messages will be added after the last line.</p> <p>When alarm data is imported from an ALA file, each setting at the time of export is also imported.</p>

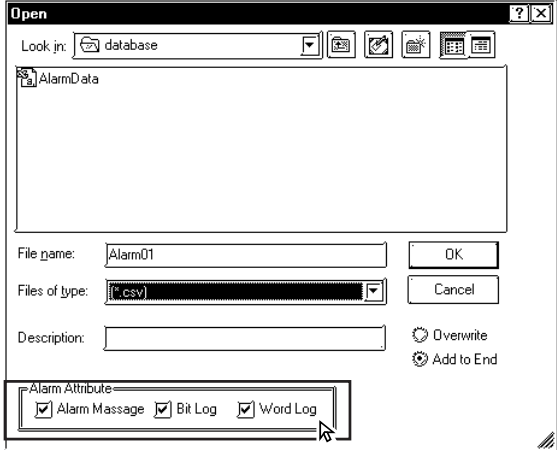
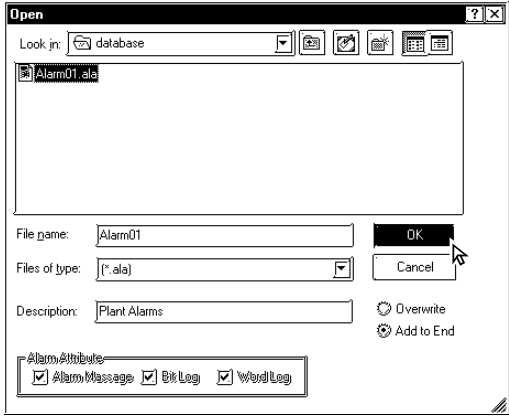
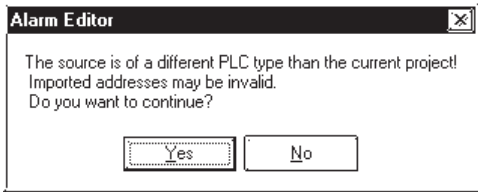
PROCEDURE	REMARKS
<p><b>(4) When selecting CSV file as imported file type, specify the type of alarm to be imported.</b> Only the type of alarm specified here will be imported.</p>  <p><b>(5) After entering all the necessary items, click on the <input type="button" value="OK"/> button.</b> If the selected Device/PLC type is different between the currently open project and the imported ALA file, the system asks if the preset addresses should be overwritten. If the preset addresses must be overwritten, select <input type="button" value="Yes"/> . If they must not be overwritten, select <input type="button" value="No"/> .</p>  <p style="text-align: center;">↓</p> 	<p>When selecting ALA file as imported file type, skip step (4).</p> <p>Once you complete the [Import] command, it cannot be undone.</p>

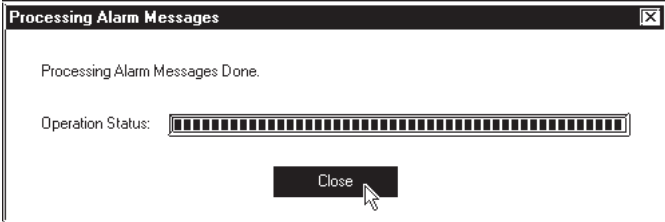
PROCEDURE	REMARKS
<p>(6) Click on the  button to quit import mode. Since you selected [Add to End] in this example, the imported messages were added after the last line.</p> 	



- When alarm data does not have an identifier "Block\*" for the first 4 lines, which indicates block settings, the alarm will not be imported.

- If the address(es) registered in the alarm data to be imported are incorrect, set correct addresses via the Symbol Editor.

**Reference** 4.9 Symbol Editor

- When the number of message characters exceeds the limit, the message is imported only for the effective number of characters.

- When data is imported from a file in which only a message is registered, the initial value is used as an address.

**Y**ou can select many of the GP unit's initial settings through the GP-PRO/PB III for Windows program. This program area is called "System Settings". When "System Settings" data is sent to the GP unit, you will not need to manually perform the initial setup of the GP unit. A description of each GP unit setting item is provided in your "GP Series User's Manual" (sold separately). For details, refer to that manual.

- 6.1 ..... **Menu Setting Items: GP Setup**
- 6.2 ..... **Printer Type**

## 6.1 Menu Setting Items: GP Setup

In the [System Settings] mode, you can easily select the GP unit's initial settings. By doing this, you don't need to manually set up the GP panel, since the [System Settings] data is sent to the GP panel automatically. After the [System Settings] data is sent to the GP panel, you can also change those settings via the GP unit itself. For the method for sending the [System Settings] data to the GP panel, **Reference** 7.2.1 *Transfer Settings*. For the method for changing the [System Settings] data with the GP unit, **Reference** *Your GP Manual, INITIALIZE*.



Some setting commands are supported by the GP unit but not by GP-PRO/PB III for Windows, or vice versa, i.e. are supported by GP-PRO/PB III for Windows but not supported by the GP unit. This section describes only the commands supported by GP-PRO/PB III for Windows. For a description of other commands, refer to your "GP Series User's Manual" (sold separately). For a description of the network setting, refer to the Device/PLC Connection Manual.

- ◆ **Setting commands Supported by Only the GP Unit:**
  - Setting Date/Time
  - Self-diagnosis command
  - Font settings (English, Korean, etc.)<sup>\*1</sup>
  - Functions for adjusting the Video Display
- ◆ **Commands Supported by Only GP-PRO/PB III:**
  - **Initial Screen Settings: [Color Setting] dialog**
  - **GP Settings: [Checksum]**  
Enables checksum verification.
  - **GP Settings: [Buzzer]**  
Select continuous or intermittent buzzer output.
  - **GP Settings: [Screen Level Change Flow]**  
Used to switch screens in the hierarchical display mode.
  - **GP Settings: [Common Password]**  
Enables or disables the Common Password setting.

<sup>\*1</sup> If any font setting other than "Japanese" is selected, "Font Setting" requires specifying whether alphanumeric characters and symbols are to be displayed at the high quality level.



- **GP Settings: [Change to Screen No.]**  
Specify the number of the screen used to replace the current one after the preset standby time has passed. If you enter “0”, no screen will be displayed.
- **I/O Settings: [Offline Mode]**  
Specify how to change from on-line mode to offline mode.
- **Mode Settings: [Device/PLC Type]**  
Displays the name of the device connected to the GP panel.
- **Mode Settings: [Option]**  
This setting is necessary only when specific Device/PLC types are selected.
- **Extended Settings: [K-tag Priority]**  
Designates the K-Tag processing mode. “Standard” mode executes the K-tag once per scan time, and “Twice” mode executes the K-tag two times per scan time.
- **Extended Settings: [Backup Settings]**  
Used to back up the GP unit's LS area data. Specify the initial address of the backup range, and the number of words used.
- **Extended Settings: [Delete Error Display](Only for programless type)**  
Displays an error message when an communication error occurs with the GP, and deletes the error message when the communication error is reset. System errors however cannot be reset, regardless of this setting.
- **Extended Settings: [Watch Dog] (Monitoring the communication status between the GP and the device)**  
Monitors the communication status between the GP and a device. The GP unit writes the data (00FFh) to the word address of the device at specified time intervals. This function enables the device (ladder programs, etc.) to check the communication states with the GP by periodically monitoring the data written by the GP (00FFh). After the data has been reviewed by the device, execute the "0 Clear" command to enable the monitoring of new data written by the GP. However,
- **Extended Settings: [CF Card Control Settings]**
  - <Data Save>  
Used to specify a control word address when saving data on the CF Card for the GP-77R and GP2000 series. The GP unit writes this control word address data to the CF card.
  - <Free Space Storage Address>  
When using a CF Card on the GP77R and GP2000 Series, specify the address to store the information on available CF card space.  
**▼Reference▼ Tag Reference Manual, 4.7 Using the CF Card**
  - <SRAM Auto Backup>  
Designate the control address used for saving the GP's SRAM data to the CF Card or restoring the data from the CF Card to the GP's SRAM in OFFLINE mode with the GP2000 series.  
**▼Reference▼ Tag Reference Manual, 4.7.9 Making a Backup of Backup SRAM**

- **Extended Settings: [Q-tag Settings]**  
When using a Q-tag, specify display and printing settings as well as extended settings.  
**▼Reference▲ Tag Reference Manual, 2.20 Q-tag (Alarm Summary bit log/word log Display)**
- **Extended Settings: [Capture Settings]**  
Designates the settings for the Control Word Address used for producing hard copies of the GP screen displaying video images.  
**▼Reference▲ Tag Reference Manual 4.7.10 Screen Capture**
- **Extended Settings: [Video Settings] (Video Window Operation Settings)**  
Settings used for displaying a video window as a global window  
**▼Reference▲ 3.6.2 Video Window Settings**
- **Extended Settings: [FEP Setting]**
- **Extended Settings: [Serial 2-D code reader]**  
(includes LS storage start address/Read complete bit address/Data storage settings)
- **Extend Settings: [Touch Panel Settings]**  
Sets the sensitivity of the GP touch panel. 3 settings are available; [High], [Medium], [Low].
- **Communication Settings: [Send Wait]**  
If the GP unit sends a command to the Device immediately after receiving a response from the Device, the Device cannot receive the command, which will cause a communication error, depending on the Device/PLC type. In this case, enter a value for the transmission wait time. If a transmission wait time has been entered, the GP unit waits for the preset time duration after receiving the Device's response, and then sends the next command to the Device.

■ Tab Setting Items

Each tab's setting items are described here.



**Note:** The setting items may differ depending on the GP type or Device/PLC type being used.

◆ GP Settings

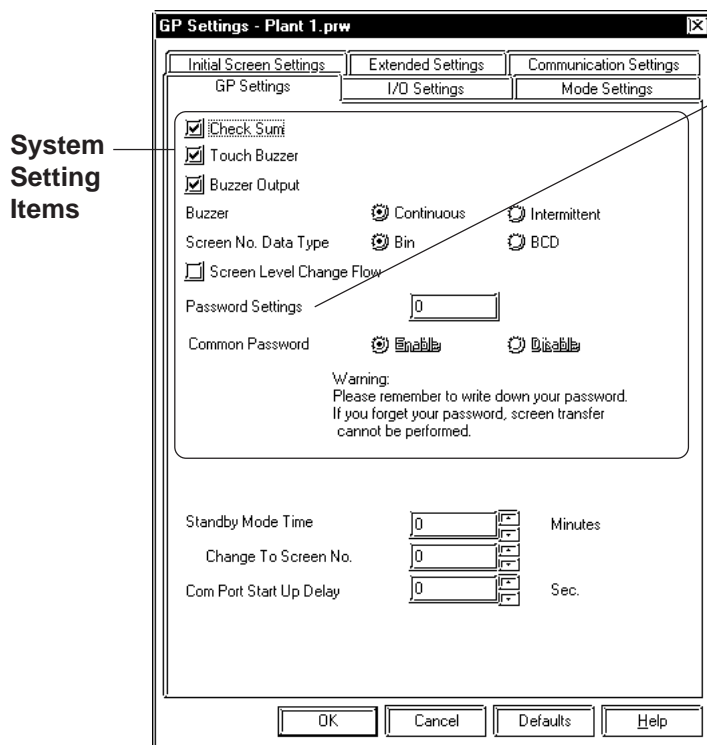

Designate the arbitrarily specified password (0-9999) or select the ON/OFF setting for the common password setting (1101).



**Important**  
**The common password (1101) cannot be used when OFF is selected. In this case, only the arbitrarily specified password can be used. Be sure to write down this password and keep it for future reference. Without the password, GP operation in OFFLINE mode is disabled.**

◆ I/O Settings

LCD Settings  
(for GP-H70L, GP-270L, GP-370L, GP-377L, GP-2301HL, GP-2300L, GP-2301L, GP-2500L and GP-2501L only)

Frame Refresh Rate Settings  
(GP-377, GP-577RS, and GP2000 Series units with Monochrome or STN Color display only.)

Sets up the function for detecting errors in Touch Panel operation (available only with GP77R and GP2000 Series units).

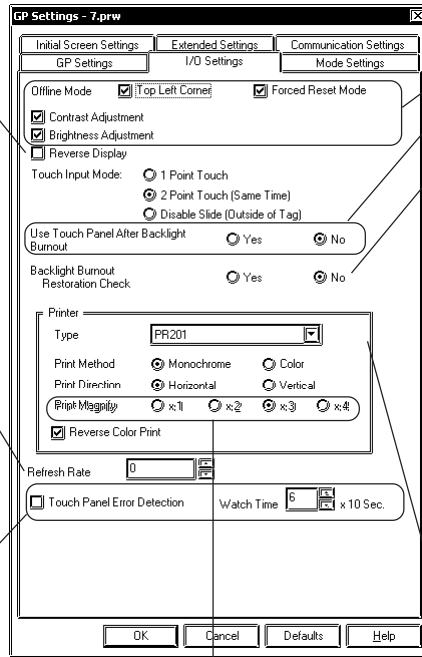

This option can only be selected when the printer type is designated as EPSON PM/Stylus (6-color ink) or EPSON Stylus (4-color ink). Available only with GP2000 Series units (except for GP-2301H, GP-2401H and GP-2301 Series units which do not have printer interfaces).

Touch Panel Settings

**Backlight Burnout Restoration Check**  
If a delay of illuminating the backlight occurs due to the characteristics of a lamp, this setting prevents the GP from making a faulty judgment regarding a backlight burnout. By selecting [No], the backlight illuminates again even if the GP has made a judgment of backlight burnout. This function is available on the GP2500 Series and GP2600 Series.



**Note:** The GP2500 Series and GP2600 series are equipped with two backlights. If "Backlight Burnout Restoration Check" is set to [Yes] with one of the two backlights completely burned out, the other backlight will blink repeatedly.

Printer Settings ("Vertical" printing is possible only with GP-675, GP-2600 and GP-2601. EPSON PM/Stylus (6-color ink) and EPSON Stylus (4-color ink) does not support "Vertical" printing.)

◆ Mode Settings

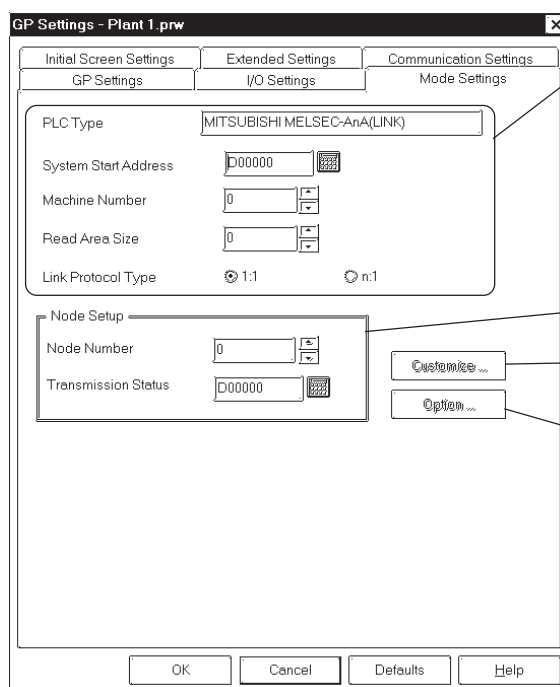

Operating Environment Settings

Node Information Settings

Customizing command (n:1)

Operating Environment Options

◆ Initial Screen Settings

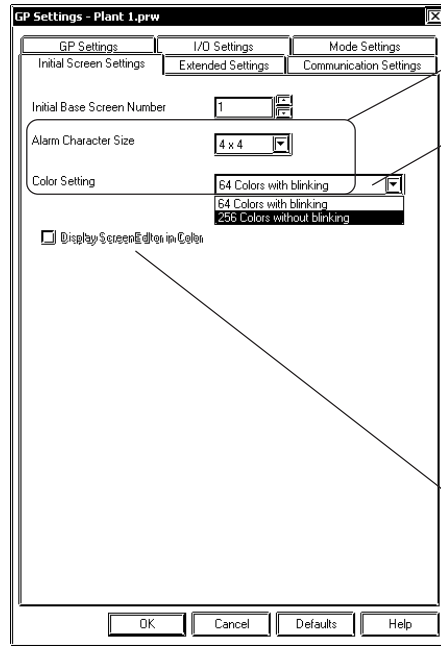

Initial Screen Settings

[64 color with blinking] is the default setting.

GP2000 Series units only (TFT color only, except GP-2301HS, GP-2301HL, GP-2300L, GP-2300S, GP-2301L, GP-2301S, GP-2500S and GP-2501S series units)

With the monochrome LCD GP (GP-2301HL, GP-2300L, GP-2301L, GP-2500L, GP-2501L), [monochrome 8-level] can be selected.

When the Color Setting is set to [Monochrome], the color bar shown on the screen editor will display 8 colors.



Depending on the color, selecting MONOCHROME 8 HUES may cause the GP unit's screen to flicker. Confirm the color before using this mode.

◆ Extended Settings

Error Handling Settings

**Font Settings**

**K-tag Processing Frequency Settings**

**Watchdog Monitoring Address and Time Settings**

**Control Address Settings for Saving CSV Data such as Alarm Screens on CF Card (GP77R (except GP-377) series and GP2000 series only)**

**Designates the address to store the information on available CF card space (only supported by the GP77R (except GP-377) and GP2000 series).**

**Adjusts Touch Panel scan sensitivity.**

**Designate the control address used for saving the GP's SRAM data to the CF Card or restoring the data from the CF Card to the GP's SRAM in OFFLINE mode (GP2000 series only).**

**String Data Settings**

**System Area Backup Command Settings**

**GP Internal Memory Data Area Settings**

**Global Window Settings**

**Video Environment and Display Settings**

**Settings for capturing the GP screen** **Reference** *Tag Reference Manual, 4.7.10 Screen Capture*

**Alarm History Display Mode Settings**

**Handy-type GP's Operation Switch (Enable/Disable) Settings**

**FEP Settings**

**Extend SIO Settings**

**Serial Code Reader**

**Reference** *Tag Reference Manual, 4.7.8 Specifying a Control Address*

**Reference** *Tag Reference Manual, 4.7.9 Making a Backup of Backup SRAM*

◆ Communication Settings Menu

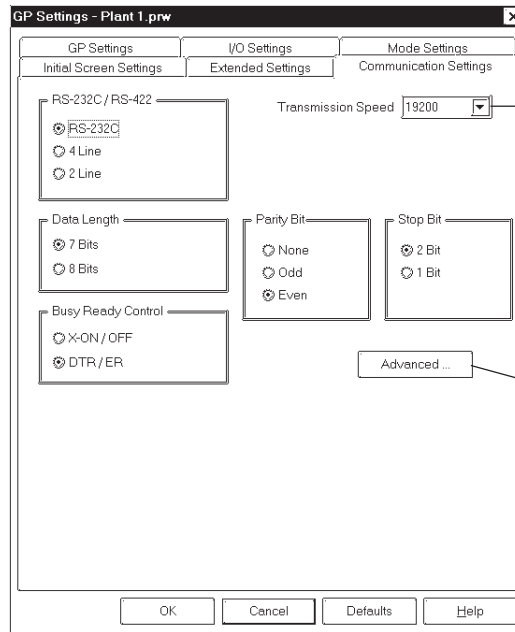

Communication Parameter Settings  
115200 and 57600 can be selected for the GP77R and GP2000 series only.

Communication Monitor Time Settings

■ GP System Settings

PROCEDURE	REMARKS
-----------	---------

(1) Via the Project Manager, select the [Screen/Setup] menu - [GP System Settings] command, or click on the  icon.

(2) Click on a desired menu tab.  
Each tab's setting items will be displayed.

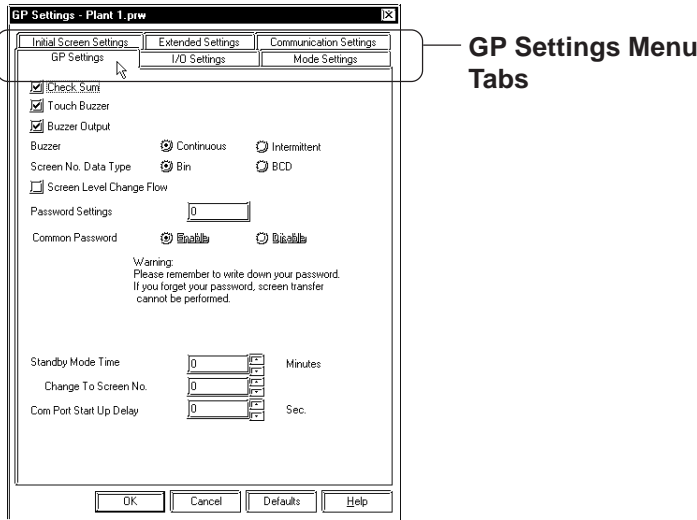

(3) After entering all the necessary items, click on the  button.

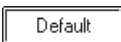
To reset each item to its default value, click on the  button.

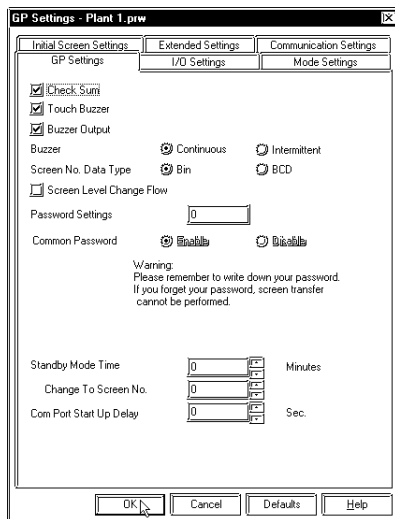

## 6.2 Printer Type

The printer type can be selected using the “GP Setup | I/O Setting” tab.

The following information explains points to be considered when selecting the printer type.

### 6.2.1 Epson PM Series / Epson Stylus Series

The following Epson PM/Stylus (6-color) printer models can be used.

Printer Model	No. of colors
PM-730C	6
PM-740C	
PM-830C	
PM-840C	
PM-870C	
PM-890C	
PM-2200C	
PM-3700C	

The following Epson Stylus (4-color) printer models can be used.

Printer Model	No. of colors
Stylus C60	4
Stylus C61	
Stylus C62	



- Epson PM/Stylus (6-color) and Epson Stylus (4-color) printers can be used only with GP2000 series units. (Except the GP-2301H, GP-2401H and GP-2301 Series units).
- Using printer models other than those mentioned above may sometimes cause improper printing. Be sure to check that the printer operates correctly.
- Printer type compatibility is subject to change as new printer models are released.
- “Vertical” printing of screen data is not supported.
- Printing is possible up to the width of A4 size paper. With GP-2600/GP-2601 series, a magnification value of 4 could cause the printout to exceed 210 mm.

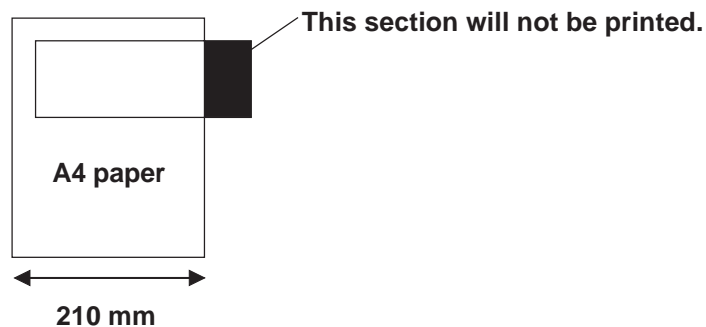



■ **Printing out GP Data**

For the Epson PM/Stylus (6-color) and Epson Stylus (4-color) printers, the following have been classified as items that can be printed out, and those that cannot be printed out.

GP Screen Data	Printout Possible
Screen data printout	YES
Q Tag (Real-time)	YES
Q Tag (Batch)	YES
Logging (Real-time)	YES
Logging(Batch)	YES
CSV Data	YES
OFFLINE Self-diagnosis (Printer I/F Check)	NO



- When printing using an Epson PM/Stylus (6-color) or an Epson Stylus (4-color) printer, GP screen update (tag processing, etc.) slows down.
- Since the OFFLINE Self-diagnosis (Printer I/F Check) is used only for ASCII code output, it will not produce correct printout.
- A magnification value of 1 to 4 can be specified while printing out the screen’s hard copy. With GP-2600T and GP-2601T units, a magnification value of 4 could cause the printout to exceed the width of an A4 size paper.
- When screen data printout uses levels of shading, the printout will differ from a different type printer (PR201, etc.). This is because colors are recognized based on shading level patterns and not on the density of shading.
- When logging data or CSV data is printed out, any section exceeding the width of A4 size paper will not be printed. Note that up to 110 single-byte characters can be printed out on one line. Be sure to check your printer’s page settings prior to printing out this data.

◆ **Printing out GP screen data**

Screen data can only be printed out horizontally.  
A magnification value of 1 to 4 can be specified.



- When using GP-2600/GP-2601 Series units, be sure to set [HARDCOPY ORIENTATION] to “PORTRAIT” within the [SET UP PRINTER] screen. Setting the option to “LANDSCAPE” may cause incorrect printing.

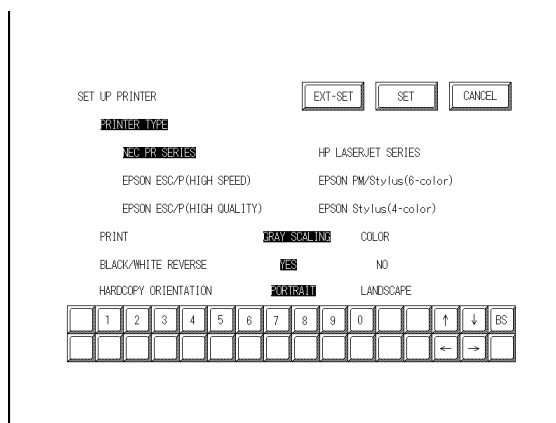



• **PRINT MAGNIFY settings**

Use the [I/O Settings] tab when setting a magnification value.

Use the [SET UP PRINTER (EXT-SET)] screen when setting a magnification value in GP OFFLINE mode.

Touching the **EXT-SET** key in the [SET UP PRINTER] screen displays the [SET UP PRINTER (EXT-SET)] screen.

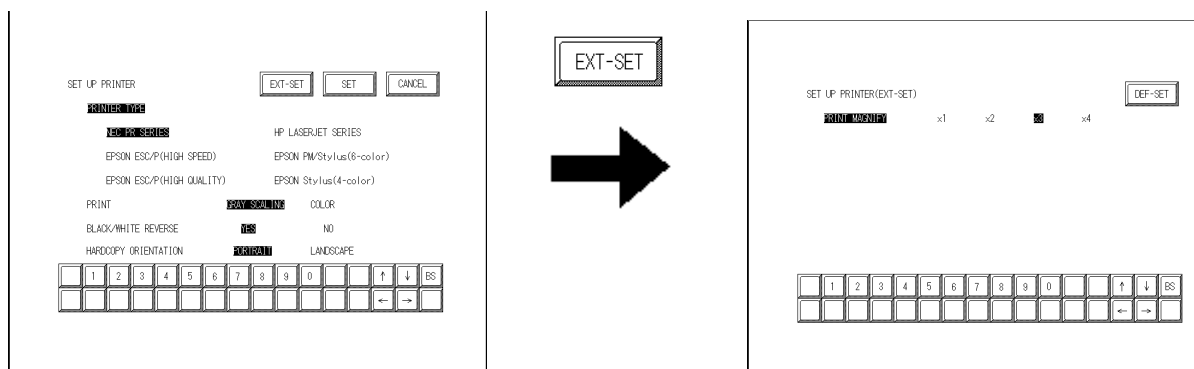

Touching any of the magnification values and touching the **DEF-SET** key takes you back to the [SET UP PRINTER] screen.

\* With GP-2600/GP-2601 Series units, a magnification value of 4 could cause the printout to exceed 210 mm.

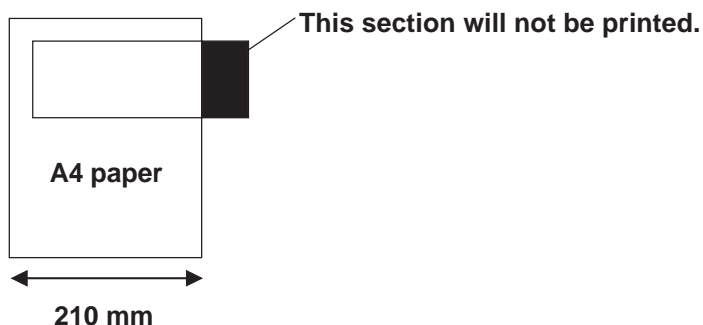

When printing using printers other than Epson PM/Stylus (6-color) or Epson Stylus (4-color) printers, touching the **EXT-SET** key displays the screen shown below. Touch the **CANCEL** key to go back to the [SET UP PRINTER] screen.

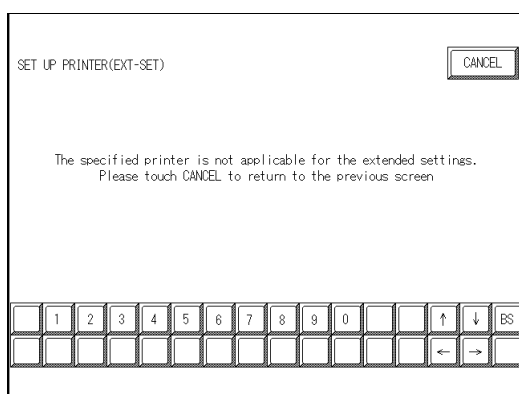

**T**o display screens created with GP-PRO/PB III on the GP unit, you must first transfer the screen data to the GP. Conversely, with the GP-PRO/PB III program, you can also transfer screen data stored in the GP unit back to your personal computer for additional editing.

This chapter describes how to transfer screen data to and from the GP unit.

7.1	.....	<b>Prior to Transferring Data</b>
7.2	.....	<b>Transferring Screens</b>
7.3	.....	<b>Options</b>
7.4	.....	<b>Setting Up Your GP via an Ethernet Network</b>

## 7.1 Prior to Transferring Data

### 7.1.1 GP Screen Transfer Cable



The GP screen can be transferred in three ways; through the GP screen transfer cable, the CF card or on Ethernet connection. This chapter describes the transfer procedure via the GP screen transfer cable. For the transfer procedure via a CF Card, **Reference** "10.7 CF Memory Loader Tool." For the transfer procedure via an Ethernet connection, **Reference** "7.2.3 2-Way Driver."

You must first connect the Data Transfer Cable to the GP unit and your personal computer before you can transfer screen data.

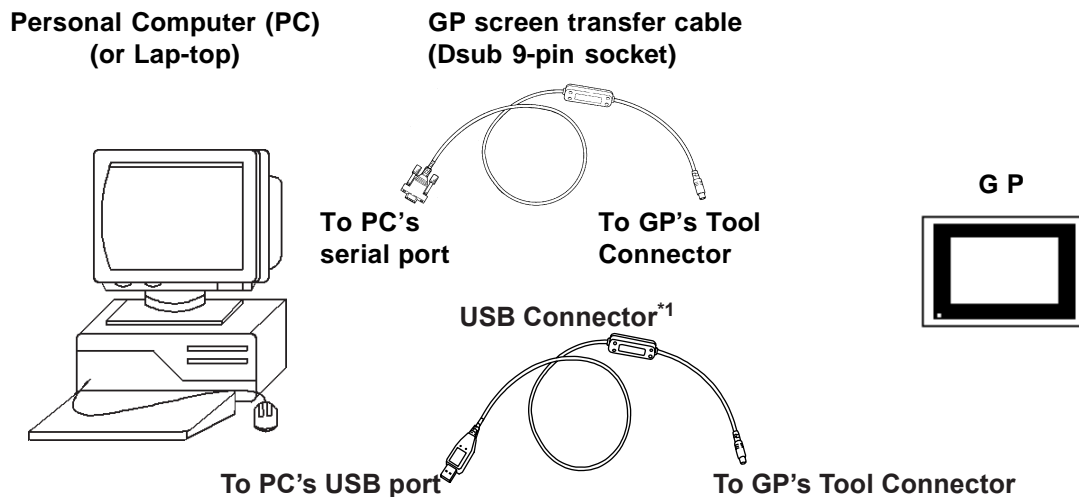

**Important**

- To transfer GP-PRO/PB III for Windows data to the GP unit, the optional cable set (GPW-CB02) is required. When your computer is equipped with USB interface, use GPW-CB03. Do not use GPW-CB02 with connecting commercially available USB conversion adapter.
- To transfer Filing Data, image screens, sound data, etc. to a CF card on the GP77R series, the Multi Unit (sold separately) and a CF card are required.
- File Transfer requires approximately three times the hard disk space occupied by the Project file.



- If a serial mouse is used, be sure to connect the cable from the GP unit to a different serial port on your PC.

\*1 For information about the USB Cable's specifications, connection method, driver installation and other items, **Reference** USB Transfer Cable Installation Guide

# 7.2 Transferring Screens

This section describes how to transfer screen data created with the GP-PRO/PB III program to and from the GP unit.

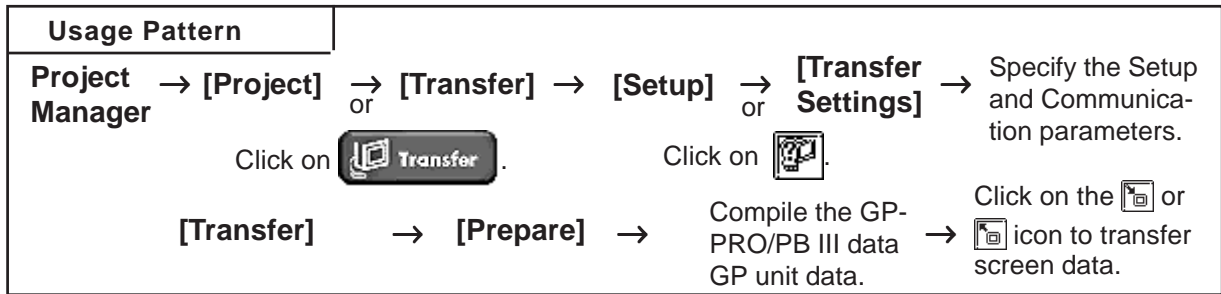

To display a screen (window) to perform data transfer, select the Project Manager's [Project] menu - [Transfer] command, or click on the



icon. Or, select the Screen Editor's [Screen] menu - [Transfer]

command, or click on the  icon. An example of this screen (window) is as follows:

The tool bar icons provide the following functions:



**Do not turn OFF the PC or the GP unit, nor disconnect the transfer cable during the transfer of screen data. This can cause an error when the GP is started.**



**When transferring the screen data from the GPPRO/PB III to the CF Card, the time stamps on the files loaded onto the CF Card are updated to the time setting of the GP at the moment of the data transfer.**

## 7.2.1 Transfer Settings

This section describes the parameter settings necessary for screen data transfer between your personal computer and the GP unit. These parameters must be reset if your personal computer has been disconnected from the GP unit, if the GP unit has been shut down, or if a nonstandard system or protocol program has been used with the GP unit.

### Transfer Settings

Select the [Setup] menu - [Transfer Settings] command, or click on the  icon. Then, a dialog box to perform data transfer settings will appear.

Specify the information to be transferred with the screen data here.

Transfers Filing Data to the CF card.  
**Reference** *Tag Reference Manual, 4.7 Using the CF Card*

Transfers Data Transfer CSV Data to the CF card.  
**Reference** *Tag Reference Manual, 4.7 Using the CF Card*  
Select the transfer mode

Select the timing for the preparation and execution of the transfer.  
**Reference** *7.2.4 Transfer Preparation*

Select the setup mode

Specify whether to transfer the upload information required to Receive data from the GP unit

Sends logic program data.  
**Reference** *Pro-Control Editor Operation Manual 5.2 Downloading to a GLC*

Select the PC serial port that will be used with the data transfer cable

Select a transfer speed.

Select the maximum number of transfer retries

Select the destination type

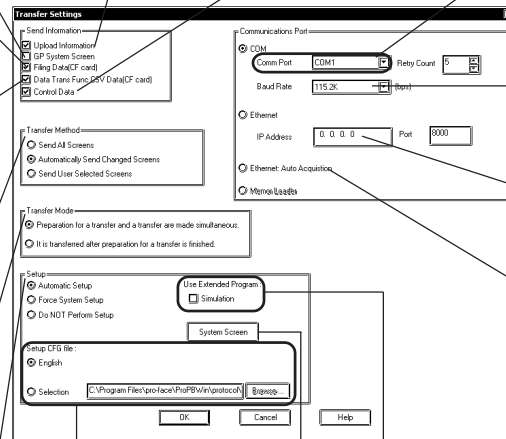

Select the setup CFG file

Sends the simulation protocol to the GP unit.  
**Reference** *8.1 Overview*

Allows you to select the data (CSV Display, File Manager Display Explorer screens, Keypad Input Display Popup Keypads) sent to the GP unit. Reduces the overall data size and speeds up data transfer.

## ◆ Transfer Mode

Send Information	
<input checked="" type="checkbox"/>	Upload Information
<input checked="" type="checkbox"/>	GP System Screen
<input checked="" type="checkbox"/>	Filing Data(CF card)
<input checked="" type="checkbox"/>	Data Trans Func CSV Data(CF card)
<input checked="" type="checkbox"/>	Control Data

**Upload parameter data**

Specify whether to send the upload parameter data in order to receive the data from the GP.



**Upload parameter data must be included to receive screen data from the GP unit. If the GP unit's memory is insufficient to include the upload parameter data, screen data can still be transferred from your personal computer to the GP unit. However, if the upload parameter data is omitted, your personal computer cannot receive screen data from the GP unit.**

**GP System Screen**

Specify whether to transfer the GP system data when sending the data to GP.



**If the [GP System Screen] setting is not checked (disabled), and the following types of Project files are sent to the GP unit, the GP unit's system settings will be reset to their initial settings.**

- **If a new version of the System, Protocol or Extend SIO programs are transferred<sup>\*1</sup>**
- **If the Protocol program is changed, if the [GP System Screen] setting is not checked (disabled) and the GP Setup is attempted, the following warning message box will appear.**

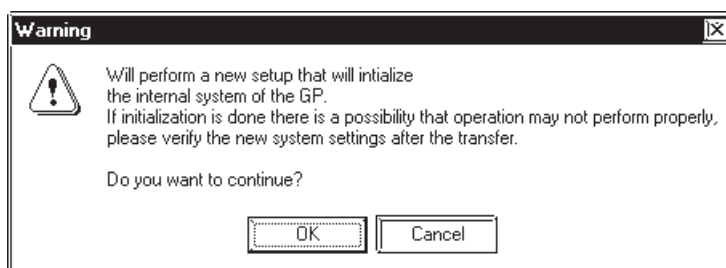

**If you do NOT wish to return the GP unit to its initial settings, be sure the [GP System Screen] setting is checked (enabled) before selecting [OK] and sending the Project, or click on [Cancel] and close the warning dialog box.**

<sup>\*1</sup> If the GP unit's current System, Protocol and Extend SIO programs are older than those used by GP-PRO/PBIII, transferring data from GP-PRO/PBIII to the GP will automatically update these programs.

**Filing Data (CF Card)**

Specify to transfer the filing data to CF card.

**Reference** *Tag Reference Manual, 4.7 Using the CF Card*

**Data Transfer CSV Data (CF Card)**

Specifies whether to transfer “Data Transfer CSV Data” to a CF card.

**Reference** *Tag Reference Manual, 4.7 Using the CF Card*

**Send Control Data**

Designates if the GLC/LT unit’s logic program data is sent or not.

**Reference** *Pro-control Editor Operation Manual, 5.2 Downloading to a GLC*

◆ **Serial Port**
**COM**

Select the serial port for connecting the transfer cable, Transfer Speed and the maximum number of transfer retries.

**Ethernet**

When using an Ethernet protocol or the 2-Way Driver, this setting designates the IP Address and Port No. used.

Prior to sending data, this feature will automatically detect and display in a list the current IP Addresses on the Ethernet network. Simply select the desired GP unit and send the data.

**Reference** *7.4 GP Setup via Ethernet, 7.2.3 2-Way Driver*

**Ethernet: Autodetect**

When using an Ethernet protocol or the 2-Way Driver, this setting allows you to send data to all or to a select number of GP units.

Prior to sending data, this feature will automatically detect and display in a list the current IP Addresses on the Ethernet network. Simply select the desired GP units and send the data.

**Reference** *7.4 GP Setup via Ethernet*

**Memory Loader**

Screen data is transferred from GP-PRO/PB III to the Memory Loader II. (Separately sold)

**Reference** *Memory Loader II Operation Manual (included with the Memory Loader II unit)*





- When Device/PLC type is "Memory Link Ethernet", screen data cannot be transferred to a CF card.
- When Device/PLC type is "Memory Link Ethernet" and you wish to transfer the screen data via Ethernet, select the [Do NOT Perform Setup].

### ◆ Transfer Method

Transfer Method	
<input type="radio"/>	Send All Screens
<input checked="" type="radio"/>	Automatically Send Changed Screens
<input type="radio"/>	Send User Selected Screens

#### Send All Screens

Transfers all screen data in a Project File to the GP unit.

#### Automatically Send Changed Screens

Any screens that have been updated in the current Project File are automatically transferred to the GP unit. This transfer mode is only effective when screens have been previously transferred to the GP unit.



**Note:** When "Automatically Send Changed Screens" is used, screens that have been deleted (not just updated) from the Project File in the GP-PRO/PB III program will not be automatically deleted from the Project File stored in the GP unit. To completely replace all screens of the Project File stored in the GP unit, be sure to use "Send All Screens". However, the data on the CF card is not deleted even if "Send All Screens" is selected. To delete data from a CF card, please initialize it.

**Reference** *Your Multi Unit User Manual*

**Send User Selected Screens**

When transferring a screen to a Project File stored in the GP unit, you must specify the screen type.



**File, log and sound data cannot be specified when transferring data.**

To select screens, click on the names of the desired screens while holding down the **Ctrl** key.

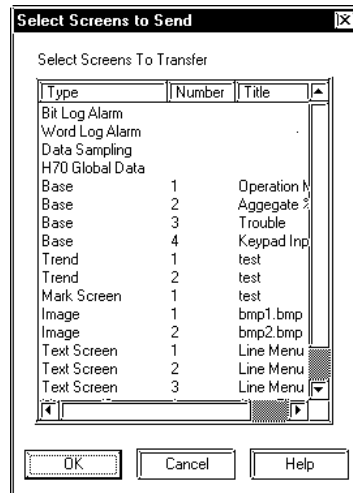

**Important**

***If "Send User Selected Screens" is selected, upload data cannot be transferred. As a result, your PC will not be able to receive screen data from the GP unit. If you need to receive screen data, select either "Send All Screens" or "Automatically Send Changed Screens" and check the "Upload Information" check box.***

***If "Send User Selected Screens" is selected, parts or texts on the screens that have not been designated may not be displayed correctly. In order to display the entire screen correctly, be sure to select the "Send All Screens" option.***

## ■ Transfer Mode

Transfer Mode

Preparation for a transfer and a transfer are made simultaneous.

It is transferred after preparation for a transfer is finished.

### **Preparation for a transfer and a transfer are made simultaneous**

Select to prepare and execute the transfer simultaneously.

### **It is transferred after preparation for a transfer is finished.**

Select to complete the preparation and check errors before executing the transfer.

## ◆ Setup

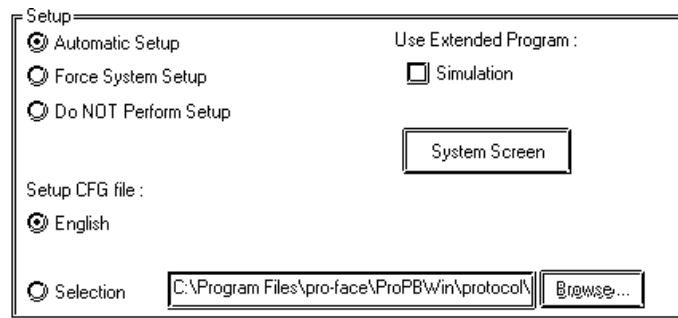
**Automatic setup :**

Set up operation is performed if necessary, according to the GP's status. Normally, select this setup mode.

**Force system setup :**

Setup operation is performed every time screen data are transferred, regardless of the GP's status.

**Do not setup :**

Setup operation is not performed, and only screen data are transferred.

**Setup CFG file :**

This is the file storing the setup information. Normally, you need not use this setup mode.

If you select "English" and perform setup, the OFFLINE screen on the GP unit will be displayed in English.



**If you have changed from Japanese to English or vice versa, be sure to specify [Forced Setup] and perform the transfer.**

**System Screen Settings**

Allows you to select the data (CSV Display, File Manager Display Explorer screens, Keypad Input Display Popup Keypads) sent to the GP unit. Reduces the overall data size and speeds up data transfer.



**This feature is available with GP-377, GP77R and GP2000 Series units. GP unit compatibility will depend on the type of model. For GP units other than those above, the items in the [System Screen Settings] dialog are not sent.**

- Keypads for File Manager Display & CSV Display

If selected, the project's CSV display and File manager display-related Explorer like screens are sent to the GP. If not selected, these screens are not sent, thereby reducing the amount of data to be transferred.



**CSV and File Manager Displays can only be viewed on a GP2000 Series unit.**

**Reference** 2.1.19 CSV Display, 2.1.20 File Manager Display

- Send Popup Keypads

If selected, you can select which of the Keypad Input Display's Popup Keypads are sent to the GP. Depending on the amount you select, the amount of data sent will be reduced.



**Note:** Popup Keypads are available only on GP-377, GP77R and GP2000 Series units. However, the Popup Keypad used for the [Specifying Entering Order] feature can only be viewed/used on a GP2000 Series unit.

**Reference**  *2.1.14 Keypad Input Display*

Selecting only the types of Popup Keypads you need to use will help to reduce the amount of data and speed up the transfer process.

## 7.2.2 Passwords

### ■ Registering a Password

To restrict unauthorized access to the screen when sending/receiving the screens, set up a (Transfer) password.

The following table shows the relationship between the Transfer password and the common password that can be set up using [Protect] in the GP Settings Screen. At the time of transfer, please confirm your password based on the following chart.





(Transfer) Password	(GP system) Common password	Password to be entered for transmission
Enabled (Example) abc	Enabled	abc
	Disabled	abc
Disabled	Enabled	1101*

\* There is no need to enter the password when transferring data from GP-PRO/PB III.

**Reference** For details of the common password, 6.1 ◆GP Settings



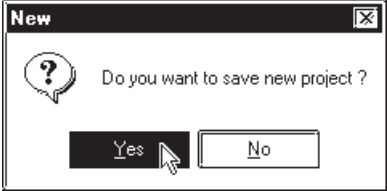
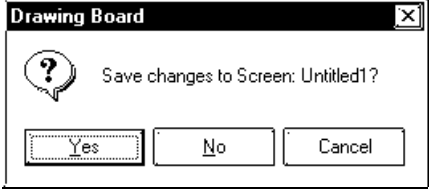
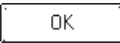







- **Be sure to keep a copy of the password in a safe place. If you forget the password, the “Transfer” function cannot be executed.**
- **The password is limited to 24 characters and only alphanumeric data (no symbols) can be used.**

PROCEDURE	REMARKS
<p>(1) Via the Project Manager, select the [Project] menu - [Transfer] command, or click on the  icon. Or, via the Screen Editor, select the [Screen] menu - [Transfer] command, or click on the  icon.</p> <p>(2) Select the [Setup] menu - [Password] command.</p> <p>(3) Enter a password.</p> 	<p>If the currently open Project File has not yet been saved in stop, the system will ask you to do so before registering a password.</p>  <p>Also, if the currently edited screen has not been saved via the Screen Editor, a prompt will appear asking if screen data is saved before transfer.</p> 
<p>(4) Enter the same password again for confirmation, and then, click on the  button.</p> 	<p>If a password has already been registered, the [Change Password] dialog box will appear.</p> 

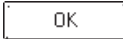
■ **Changing a Password**

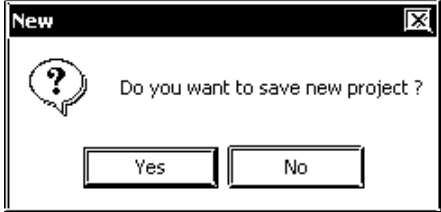
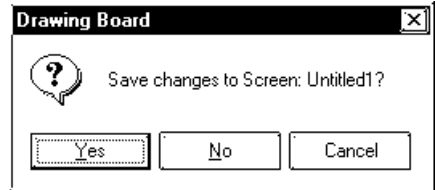
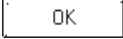
The registered password can be changed or canceled.

PROCEDURE	REMARKS
<p>(1) Via the Project Manager, select the [Project] menu - [Transfer] command, or click on the  icon. Or, via the Screen Editor, select the [Screen] menu - [Transfer] command, or click on the  icon.</p> <p>(2) Select the [Setup] menu - [Password] command.</p> <p>(3) In order to change a password, you must first enter the currently registered password.</p>  <p>(4) Enter a new password.</p>  <p>(5) Enter the same password again for confirmation, and then, click on the  button.</p> 	<p>If the currently open Project File has not yet been saved in step (1), the system will ask you to do so before registering a password.</p>  <p>Also, if the currently edited screen has not been saved via the Screen Editor, a prompt will appear asking if screen data is saved before transfer.</p>  <p>To cancel the password, after entering the currently registered password in step (2), DO NOT enter a new password in step (3) and simply click on the  button.</p> 

**7.2.3 2-Way Driver**

The 2-Way feature provides a system in which an upper-level (Host) computer accesses GP or device data via a network (Ethernet).



- The Pro-Server with Pro-Studio for Windows software is required to use the 2-Way feature.
- This feature is available on GP77R and GP2000 Series units (except for GP-2301H/GP-2401H/GP-2301/GP-2401 Series units). GP77R , GP-2501, and GP2601 Series units require the optional Ethernet I/F Unit.

**Reference** *Pro-Server with Pro-Studio for Windows Operation Manual*

PROCEDURE	REMARKS
<p>(1) Select the Transfer area [Setup] menu's [2Way Driver] command.</p> <p>(2) Designate the 2Way Driver.</p>	<p><b>Reference</b> <i>Pro-Server with Pro-Studio for Windows Operation Manual</i></p> <p>When selecting a [Network Project File] or a [Participating Node], be sure the OS installed in your PC is Windows95 OSR2 or later.</p> <p>The Network Project file's data is not sent via Ethernet. To transfer the Network Project files, use the Serial communication or Pro-Server with Pro-Studio for Windows.</p>



- If you transfer the GP screen data alone to the GP to which the network project file has been already downloaded, the network project file might be deleted depending on transfer settings or a transfer method.

		Transfer Method	
		Transfer Cable	Ethernet Transfer
Setting	Transfer with [Send All Screens]	Delete	Remain
	Transfer with [Automatically Send Changed Screens]	Remain	Remain
	Transfer with [Force System Setup]	Delete	Remain



## 7.2.4 Transfer Preparation

The Project File (PRW file) data created with the GP-PRO/PB III program is first compiled before it is transferred to the GP unit.

Select the [Transfer] menu - [Prepare] command to compile your data.

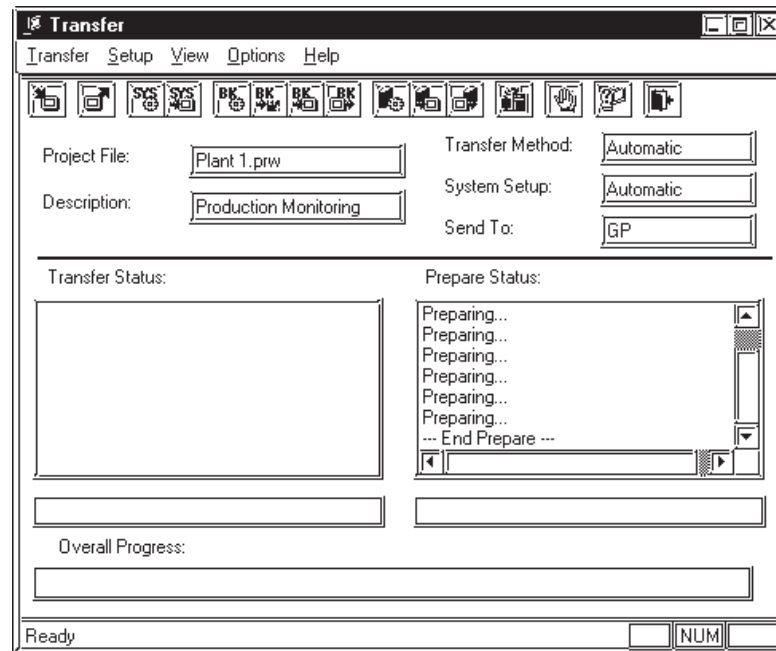

- To prepare the transfer, about the 3 times the project file size is required in your computer's hard disk.
- After the [Prepare] command is finished, you can check the GP unit's current memory capacity with the [Project Information] feature.

### **Reference** 4.5.1 Project Information





- Once you use the [Prepare] command, you do not need to use it again for the same data, unless the data has been updated.
- If the Project File (PRW file) to be transferred is stored on your PC's floppy disk, copy it to your PC's hard disk prior to using "Prepare" to reduce transfer time.
- If the [Transfer Settings] → [Transfer Mode] area's [Preparation for a transfer and a transfer are made simultaneous] selection is checked, the time required for data transfer can become long. If you wish to shorten the data transfer time, please select [It is transferred after preparation for a transfer is finished].

### 7.2.5 When Sending Screens To the GP



To display screens created with GP-PRO/PB III program on the GP panel, you must first transfer the screen data from your personal computer to the GP unit.



**If the GP unit is not connected to the device when the screen data are transferred to the GP unit and the “Change State” function is set to “Yes”, bit switches, toggle switches, lamps, and objects will not be displayed on the GP panel after data transfer.**





PROCEDURE	REMARKS
<p>(1) Via the Project Manager, select the [Project] menu - [Transfer] command, or click on the  icon. Otherwise, via the Screen Editor, select the [Screen] menu - [Transfer] command, or click on the  icon.</p> <p>(2) Select the [Transfer] menu - [Send] command, or click on the  icon.</p> <p>If the currently open Project File has not been prepared for data transfer (the Project File has not been compiled), then the system automatically compiles the Project File before transferring it to the GP unit.</p> <p>To transfer a screen to the GP unit for the first time, set up the GP unit*1 first, and then transfer the screen data. The number of screens transferred is displayed in [Transfer Status].</p> <p>If the Device/PLC type of a screen or Project File to be transferred is different from the GP's existing internal screen type, the following message will appear. When you click on the <input type="button" value="OK"/> button, the system starts setup operation, and then transfers the screen data.</p> <div data-bbox="209 1563 539 1720" style="border: 1px solid black; padding: 5px; width: fit-content;"> <p><b>Protocol Download</b></p> <p>PLC type is Different. OK to Continue?</p> <p><input type="button" value="OK"/> <input type="button" value="Cancel"/></p> </div> <div data-bbox="587 1563 917 1720" style="border: 1px solid black; padding: 5px; width: fit-content;"> <p><b>GP's Project File is Different!</b></p> <p>Sending All Files</p> <p><input type="button" value="OK"/> <input type="button" value="Cancel"/></p> </div> <p>After set up is completed, the GP panel screen is automatically switched to the OFF-LINE mode. Confirm the initial setting on the GP panel, and adjust the settings as required.</p>	<p>If the currently open Project File has not yet been saved in stop (1), the system will ask you to do so before registering a password. Select <input type="button" value="Yes"/> to save, or <input type="button" value="No"/> to not save.</p> <div data-bbox="948 936 1337 1126" style="border: 1px solid black; padding: 5px; width: fit-content;"> <p><b>New</b></p> <p>Do you want to save new project ?</p> <p><input type="button" value="Yes"/> <input type="button" value="No"/></p> </div> <p>Also, if the currently edited screen has not been saved via the Screen Editor, a prompt will appear asking if screen data is saved before transfer.</p> <div data-bbox="948 1335 1305 1485" style="border: 1px solid black; padding: 5px; width: fit-content;"> <p><b>Drawing Board</b></p> <p>Save changes to Screen: Untitled1?</p> <p><input type="button" value="Yes"/> <input type="button" value="No"/> <input type="button" value="Cancel"/></p> </div> <p>Make sure that the GP unit is in the “Transfer Screen Data” mode or “RUN” mode. However, for the GP-377 Series or GP77R Series, when the built-in 2 port function is specified in the GP, be sure to select Transfer mode.</p> <p><b>Reference</b> <i>GP Series User's Manual (sold separately): Chapter 5 Initialize</i></p> <p>To cancel the data transfer mode, click on the  icon.</p>

\*1 “GP setup” means to download the system program and protocol program from GP-PRO/PB III to the GP unit so that the GP unit can operate in the specified environment.

PROCEDURE	REMARKS
<p>(3) After screen data transfer is completed, select the [Transfer] menu - [Exit] command, or click on the  icon.</p>	<p>Data transfer mode will automatically quit when the GP unit's internal memory capacity becomes insufficient.</p> <p> <b>Important</b> When you transfer a screen to a GP unit with a SRAM, backup data will be deleted.</p>

**■ Transferring a Screen Using a Password**

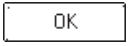
If a password has been registered, you must enter it to transfer data to the GP unit.

PROCEDURE	REMARKS
<p>(1) Via the Project Manager, select the [Project] menu - [Transfer] command, or click on the  icon. Or, via the Screen Editor, select the [Screen] menu - [Transfer] command, or click on the  icon.</p> <p>(2) Select the [Transfer] menu - [Send] command, or click on the  icon.</p> <p>(3) Enter the registered password, and click on the  button to confirm it. The data transfer operation will start.</p> <div data-bbox="247 1478 662 1680" style="border: 1px solid black; padding: 5px;"> <p>Password Entry</p> <p>Enter Password:</p> <p>xxxxxx</p> <p>OK Cancel Help</p> </div> <p>(4) After screen data transfer is completed, select the [Transfer] menu - [Exit] command, or click on the  icon.</p>	<p>If you enter an incorrect password three times or more, data transfer cannot be performed. In this case, repeat the transfer procedure from step (2).</p> <div data-bbox="989 1377 1292 1512" style="border: 1px solid black; padding: 5px;"> <p>Invalid Password!</p> <p>Please Retype password</p> <p>OK</p> </div> <p>To cancel data transfer mode, click on the  icon.</p>





**7.2.6 When Receiving Data From the GP**



Screen data stored in the GP unit can be received on a project file basis by the GP-PRO/PB III.

To receive transferred screen data with the password registered, password entry is required when receiving the data.

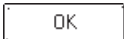
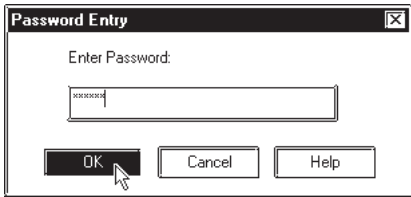

- **When screen data is created via the GP-377, GP77R or GP-2000 Series' Project File with a data transmission speed of 115.2 Kbps or 57,600 bps and received from the above-mentioned GP unit and transferred to another GP unit other than the above-mentioned, this speed is automatically changed to 38,400 bps. Therefore, set the device's data transmission speed to 38,400 bps.**
- **When sending data from the GP to GP-PRO/PBIII, be sure to select "Upload Information" in the [Transfer Settings] dialog box before sending the project file to the GP.**

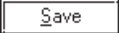
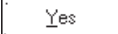
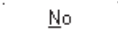
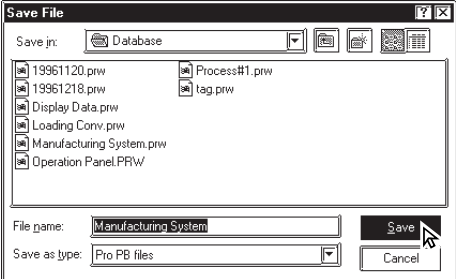
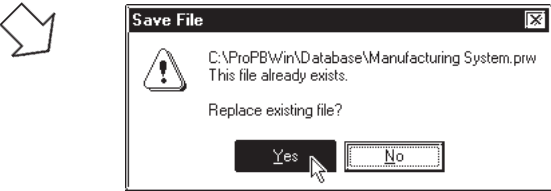
PROCEDURE	REMARKS
<p>(1) Via the Project Manager, select the [Project] menu - [Transfer] command, or click on the  icon. Or, via the Screen Editor, select the [Screen] menu - [Transfer] command, or click on the  icon.</p> <p>(2) Select the [Transfer] menu - [Receive] command, or click on the  icon.</p> <p>(3) When a password has been registered, enter it and click on the  button.</p> 	<p>When a password has not been registered, skip step (3).</p> <p>If you enter an incorrect password three times or more, data transfer cannot be performed. In this case, repeat the transfer procedure from step (2).</p> 

PROCEDURE	REMARKS
<p>(4) Specify a location (directory) and Project file to store the received data. Then, click on the  button.</p> <p>If the same Project File name already exists, the system asks if you wish to replace it; if so, select , otherwise select  .</p>   <p>(5) After the data transfer is completed, select the [Transfer] menu - [Exit] command, or click on the  icon.</p>	<p>To cancel data transfer mode, click on the  icon.</p>

### 7.2.7 Sending/Receiving Dictionary File

This feature allows you to create, send and receive a dictionary file used in a Japanese FEP. This feature is available only with the GP2000 series.



**Note:** Receiving and sending via Ethernet is also available.

#### ■ Creating a Dictionary File

Select [Create Dictionary] from the [Transfer] menu to create a dictionary.

The dictionary created (about 500KB) is written into the CF Card output folder. If a dictionary file already exists on the CF Card output folder, the following dialog box appears asking whether the existing file should be overwritten

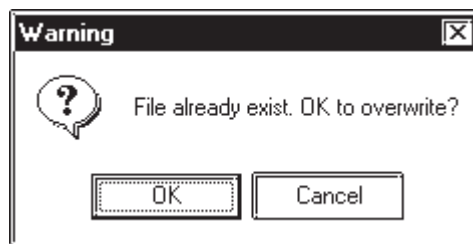

#### ■ Sending a Dictionary File

Select [Send Dictionary] from the [Transfer] menu to create and send a dictionary file to the CF Card attached to the GP unit.

The dictionary created is written into the CF Card output folder before it is sent. If a dictionary file already exists on the CF Card output folder, the following dialog box appears asking whether a new dictionary should be created.

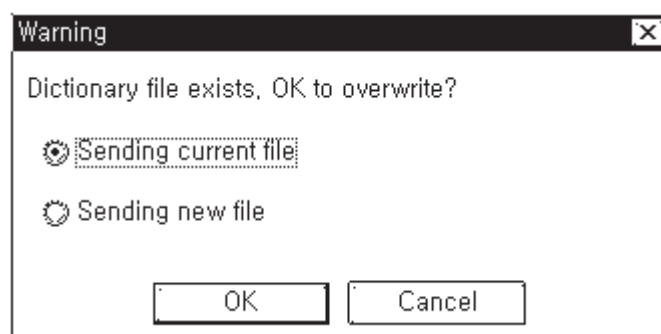

### ■ Receiving a Dictionary File

Select [Receive Dictionary] from the [Transfer] menu to load a dictionary file from the CF Card attached to the GP unit. The received dictionary file is loaded to the CF Card output folder. If a dictionary file already exists on the CF Card output folder, the following dialog box appears asking whether the existing file should be overwritten.

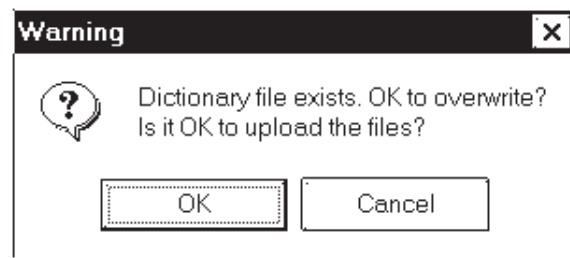

- The Receive Dictionary feature enables other GP units to use a specific dictionary file in which the list of candidates for kanji-kana conversion is sorted by the order of frequency of usage according to a learning function.
- The learning function uses the backup SRAM. Up to 1KB (about 100 words) of backup SRAM is available. If the allotted 1KB is exceeded, the data are deleted starting with the least-recently used data.

### 7.2.8 Start GP-Web Compiler

This feature prepares for the transfer of a Project file and activates the GP-Web Compiler.

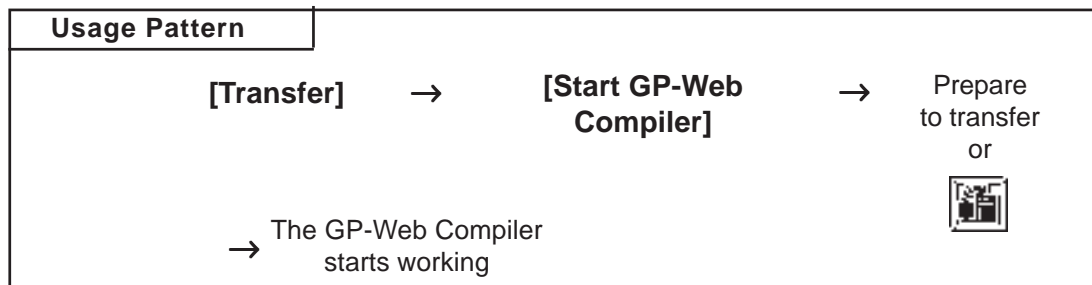

To operate the GP-Web Compiler:

**Reference** *GP-Web Operation Manual*

## 7.3 Options

In addition to transferring/receiving screen data, you can check the screen information on the connected GP Unit using the GP-PRO/PB III program.

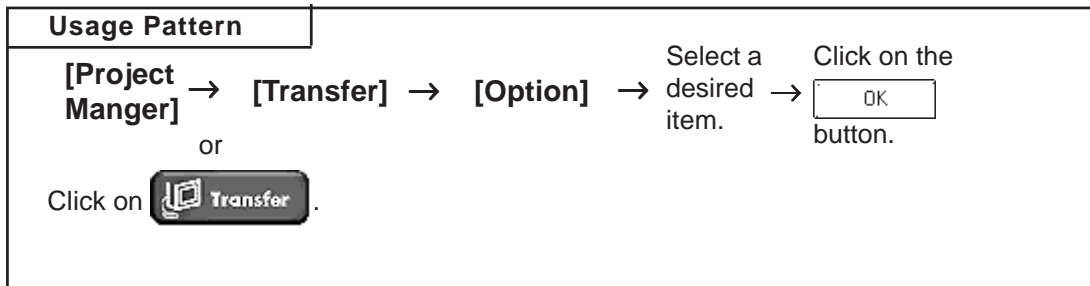

### 7.3.1 GP Internal Screen Data Information

Internal information from the GP will be displayed. Functions such as [Screen List], [Memory Info], [GP Version], [Compare List] and [Upload Stored Data of CF Card] are available.

#### ■ List Screens

The screen name, data volume and title of the screens stored in the GP unit are listed by screen type.

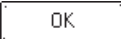
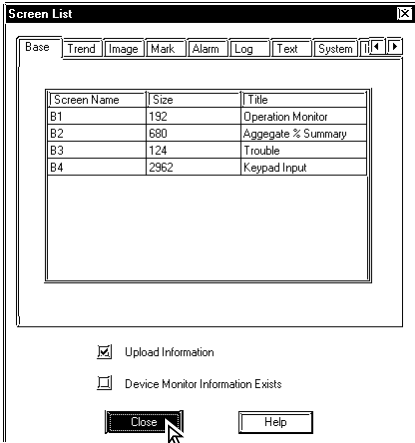
PROCEDURE	REMARKS
<p>(1)Select the [Options] menu - [Screens List] command. Screens of the current project will be listed.</p> <p>(2)After confirming the displayed information, click on the  button to close the screen list.</p> <p><b>[Upload Information]:</b> .. Indicates if the upload information has been transferred to the GP unit or not.</p> <p><b>[Device Monitor Information Exists]:</b> ..... Indicates if the device monitor function has been registered or not.</p> 	



■ **Memory Information**

The GP unit’s current memory capacity for each bank is displayed. Its maximum internal memory capacity is also displayed.

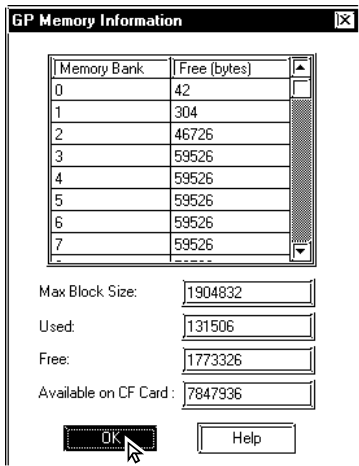
PROCEDURE	REMARKS
<p><b>(1) Select the [Options] menu - [Memory Info] command.</b> The receiving of memory information begins.</p> <p><b>(2) After confirming the displayed information, click on the <input type="button" value="OK"/> button to close the memory information window.</b></p> <p><b>[Max Available]</b> .....Displays the GP unit’s allowable memory capacity.</p> <p><b>[Used]</b> .....Displays the data volume currently used in the GP unit.</p> <p><b>[Free]</b> .....Displays the amount of “free”, or remaining memory.</p> <p><b>[Available on CF Card]</b> ... Shows the remaining capacity of the CF card.</p> 	<p>Number of banks provided in each GP model:</p> <ul style="list-style-type: none"> <li>GP-H70: 16 banks</li> <li>GP-270: 4 banks</li> <li>GP-370: 16 banks</li> <li>GP-470: 16 banks</li> <li>GP-570: 16 banks</li> <li>GP-571: 48 banks</li> <li>GP-675: 32 banks</li> <li>GP-870: 16 banks</li> <li>GP-377: 16 banks</li> <li>GP77R: 32 banks</li> <li>GP-2301H: 16 banks</li> <li>GP-2401H: 32 banks</li> <li>GP-2300: 32 banks</li> <li>GP-2301: 16 banks</li> <li>GP-2400: 64 banks</li> <li>GP-2401: 32 banks</li> <li>GP-2500: 64 banks</li> <li>GP-2501: 32 banks</li> <li>GP-2600: 64 banks</li> <li>GP-2601: 64 banks</li> </ul> <p>(The capacity for each bank is 59526 bytes.)</p> <p>A single screen file cannot be stored in several banks. Therefore, the sum of the remaining memory capacity for each bank is not always equal to the transferrable screen data volume.</p>

**■ GP Version**

The GP unit's version is displayed.

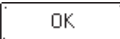
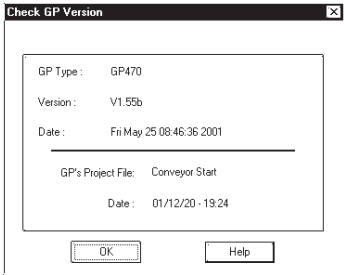
PROCEDURE	REMARKS
<p>(1)Select the [Options] menu - [GP Version] command. The receiving of the version information begins.</p> <p>(2)After confirming the displayed information, click on the  button to quit.</p> 	

**■ Compare List**

When the project file (\*.prw) currently selected with the PC is transferred to the GP, the transferred file and the file already in the GP are compared to find any differences.

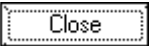
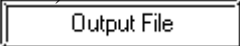
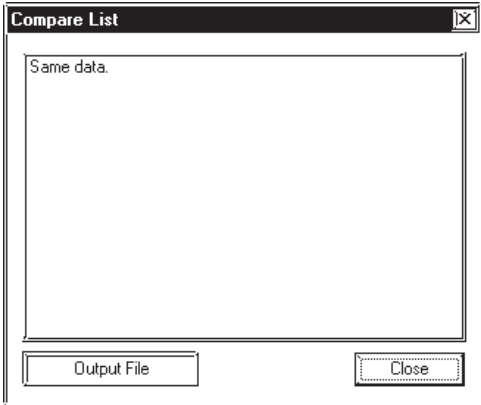

- When transferring a project file to the GP, be sure to transfer the upload information as well.

PROCEDURE	REMARKS
<p>(1)Select the [Options] menu - [Compare List] command. Receive the data to be compared.</p> <p>(2)After confirming the information displayed, click on the  button to close the comparison screen To save the comparison result, you can output the data as a text file (*.txt). Click on the  button.</p> 	<p>When the comparison operation yields no results, the message “No differences found” will be displayed.</p> <p>Differences will arise in the following situations:</p> <ul style="list-style-type: none"> <li>• When the project files to be compared are different.</li> <li>• When the GP unit and PC have the same screen number but different screen contents.</li> <li>• When the screen exists only for the GP unit or the PC.</li> </ul>

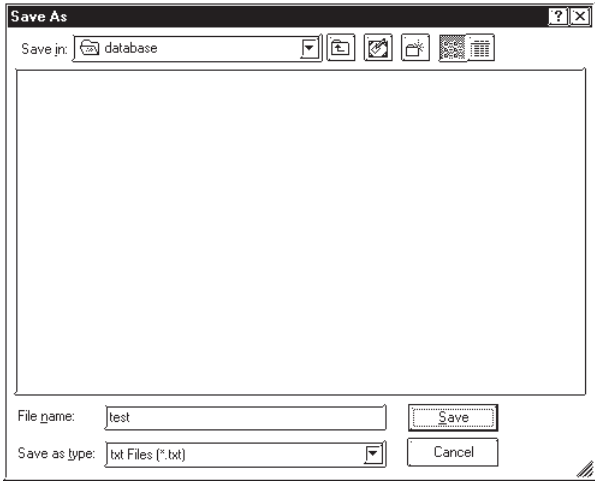
PROCEDURE	REMARKS
<p>To save the comparison data, designate the location and file name and click on the  button.</p> 	

**■ Receiving CF Card Data**

Data (\*.CSV) stored on a GP's CF Card such as alarms, trend graphs, sampled data, and logged data, can be read into your PC by GP-PRO/PBIII for Windows and then used in Microsoft Excel.

**Reference** Tag Reference Manual, 4.7 Using the CF Card



**• This feature is supported only by the GP77R and GP2000 series. With GP77R series units, this feature requires the optional Multi Unit (sold separately).**

**• The data-transferring CSV files (ZR\*\*\*\*\*.CSV) cannot be received.**

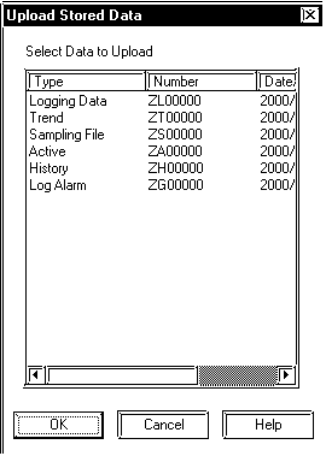
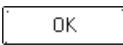
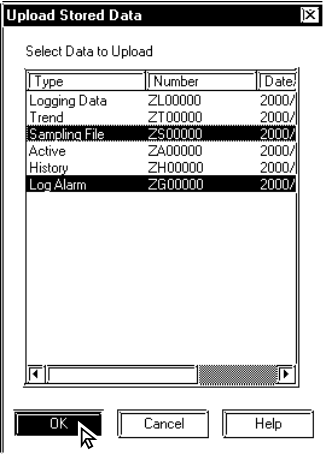
PROCEDURE	REMARKS
<p>(1) Select the [Options] menu - [Upload Stored Data of CF Card] command. The files stored on the GP unit's CF card will be listed.</p> 	
<p>(2) Select data to be uploaded to your PC and click on the  button.</p> 	

## 7.4 Setting Up Your GP via an Ethernet Network

The 2-Way driver program is pre-installed in the GP2000 (except GP-2501/2601), which allows you to both set up your GP and transfer GP Screens. GP2000 series units also allow you set up a completely new GP from the GP's Initial Start Mode screen.



**Important**

**Setup via the Initial Start Mode screen is available only with the GP2000 series (except the GP-2501/2601 Series).**



**Note:**

- An optional Ethernet Interface (sold separately) is required to connect the GP-2501/2601 Series to an Ethernet network.
- The GP2000H, GP-2301 and GP-2401 series cannot be connected to an Ethernet network.

### ■ System Design

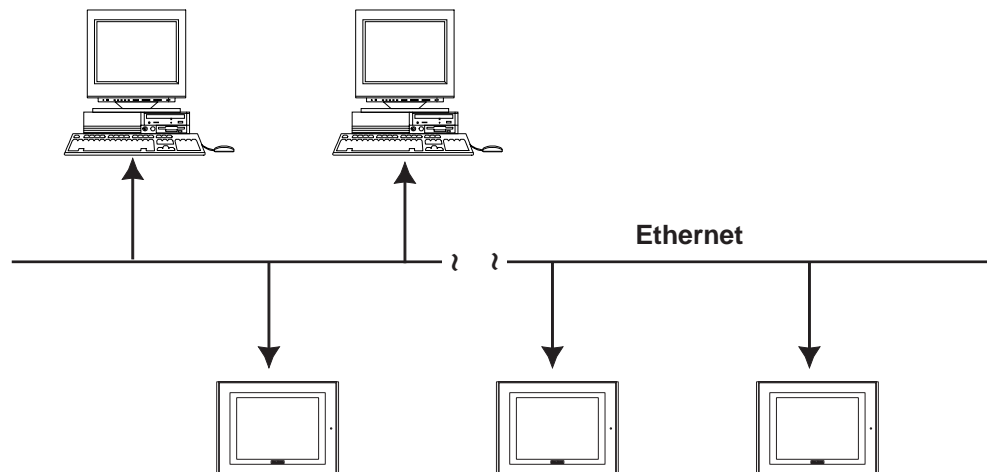

**Important**

- Be sure to enter your GP's Ethernet setting information (IP address, Port number) prior to using the Ethernet network.
- When the default IP address is used, it is not necessary to set up an IP address. **Reference** 7.4.1 Data Transfer Using the Factory-set IP Address (The GP-2501/2601 series cannot transmit with the default IP address.)
- If both GP2000 series units and GP70/77R units are used together on the same Ethernet network, even though GP2000 Series units can be set up via this network, GP70/77R Series units (with the Memory Link communication protocol or the 2-Way Driver installed) can only receive GP-PRO/PBIII project screen data.



**Note:**

The GP-2000 series allows screen transfers via Ethernet regardless of the Device/PLC type. (Depending on the type of Device/PLC used, screen transfers via Ethernet may not be available with the GP-2501/2601.) However, if the GP is not set up for Ethernet network data transfer, this feature cannot be used. If an Ethernet network cannot be used, connect the separately sold GP transfer cable (GPW-CB02, GPW-CB03) to transfer your data.

## ■ Factory Settings

The following “Initial Start Mode” screens will appear when you first connect the GP’s power cord. (The following screen is displayed only on the GP2000 series. A stock GP-2501/2601 does not allow Ethernet settings to be designated. GP-2301H, GP-2401H, GP-2301 and GP-2401 Series can not be connected to the Ethernet.)

**Display for English mode users**

**Touch here to call up the ETHERNET SETUP screen**

If you touch the “Ethernet Setup” button, the following screen will appear. You can use this screen to enter your Ethernet settings (IP address, Port number, etc.)

**Touch here to enter your settings and return to the Initial Start Mode screen**

**Note:** If you do not wish to use an Ethernet network for data transfer, you do not need to set up the Ethernet information settings. You can set up your new GP from GP-PRO/PBIII via the GP’s separately sold data transfer cable (GPW-CB02, GPW-CB03).





**When you first set up your GP, you need to use the GP-PRO/PBIII Transfer area transfer setting screen’s “Automatic Setup” feature. However, if you select “Do NOT perform Setup”, the GP’s system data will not be sent from GP-PRO/PBIII and the GP’s Initial Start Mode screen will appear again.**

**Reference** For details about Ethernet settings, refer to your GP2000 Series unit’s User Manual.

■ Transfer Settings

After you have completed entering your GP's Ethernet settings, use the GP-PRO/PBIII "Transfer" area settings dialog box to designate the data transmission method.

PROCEDURE	REMARKS
-----------	---------

(1) Select [Transfer] from the Project Manager's [Project] window, or click on . (You can also select [Transfer] from the Drawing Board screen's [Screen] menu or click on .) The [Transfer] screen will appear.

(2) Select [Setup] menu's [Setup] from the [Transfer] screen, or click on , and the following [Transfer Settings] screen will appear. Designate all necessary settings.

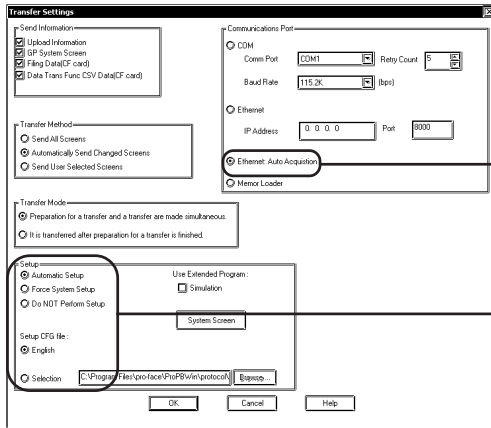

Select either Ethernet, or Ethernet Auto Acquisition.  
Select a setup type and CFG file





For details on the "Setup" type:

**Reference** 7.2.1 Transfer Settings ◆ Set up

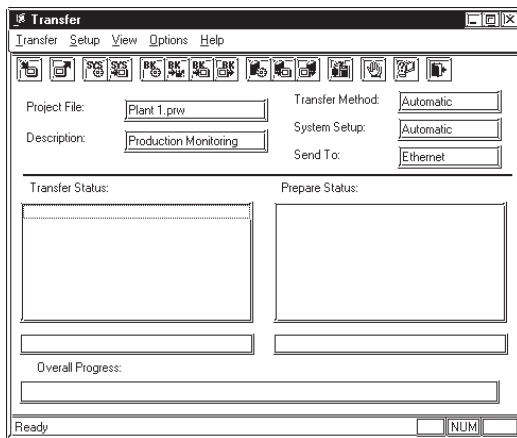
When designating the destination GP unit, both the Ethernet (send to a single GP), and the Ethernet Auto Acquisition (send to all GP units on the network) features can be used.

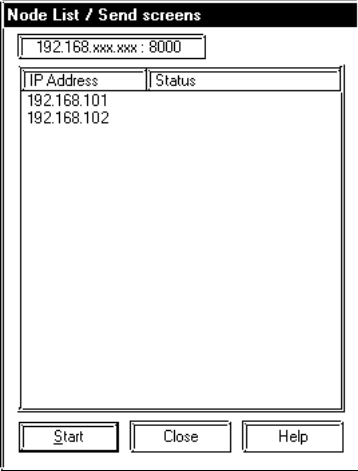
(3) Next, select [Send] from the [Transfer] menu, or click on  to start data transfer.

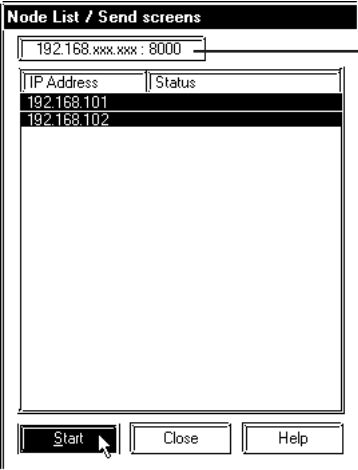

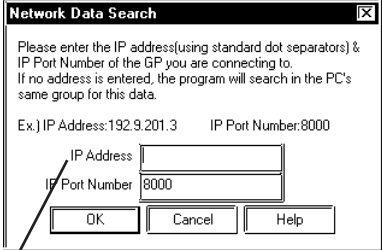
PROCEDURE	REMARKS
<p>Next, the [Node List/Send screens] dialog box will appear. Here you can see the IP addresses of all GPs connected to the network.</p>  <p>(4) Select the IP address of the GP you wish to transfer data to, and click on  .</p> 	<p>When receiving data, only one address can be selected.</p> <p>The [Node list/Send screens] window only lists the GPs which correspond to the subnet masks of the PCs used for data transfer.</p> <p>When the Network Project file set using Pro-Server with Pro-Studio is sent to the GP unit, the names of the participating nodes are displayed. For detailed information, see the Pro-Server with Pro-Studio Operation Manual.</p> <p>Click on  and the [Network Data Search] dialog box will appear. This dialog box allows you to search for a specific GP using the GP's IP address. The result will be displayed on the [Node List/Send screens] dialog box. If you do not change the current search condition, this feature will automatically search using the current data. Therefore, be sure when using this feature that the current search condition is the one that is actually desired.</p>  <p>Refer to the example and enter numerical values in the IP Address field. When the address is designated with characters other than numerals (text, etc.), the entry from the beginning of the invalid entry to the end of the IP address is recognized as "0".</p>



PROCEDURE	REMARKS
	<p>When designating “Ethernet Auto Acquisition” in the environment using more than two LAN cards, the target GP cannot be explored because OS explores GP connected to the LAN card that OS firstly finds. Please designate “Ethernet” in [Transfer Settings] dialogbox, enter the GP’s IP Address directly, then transfer the data.</p>

**7.4.1 Data Transfer Using the Factory-set IP Address**

The default IP address of the GP is set at the factory for high-speed transfers of setups and screens via Ethernet.



- ***This function is available only with GP2000 (except GP-2301H, GP-2401H, GP-2301, GP-2401, GP-2501 and GP-2601) Series units.***

The IP address of the GP unit is factory-configured. The IP address is used when the IP address/Subnet Mask setup on the GP is "0.0.0.0".

Requirements for the use of the factory-set IP address

IP address / subnet mask	IP Settings Used
If set to 0.0.0.0	Factory set IP address
any other IP address	IP address set up arbitrarily



- ***Be sure to set the TCP/IP data (IP address should be set from 10.255.255.1 to 10.255.255.254) and the subnet mask (255.0.0.0) of a PC that is running GP-PRO/PB III for Windows, and where Ethernet screen transfer will be performed. Also, some PCs must be rebooted for the TCP/IP setting to be activated.***
- ***When the GP unit’s IP address and subnet mask are set (an S200 file is generated), the TCP/IP data (IP address and subnet mask) used by the PC should be the same.***
- ***Do not use the factory-set IP address when a private address (010.xxx.xxx.xxx) is used on the same network. Otherwise, a network communication error may occur.***

Click on the "Send" icon and GP-PRO/PBIII will search for the IP addresses of the GP units connected to the network. If a GP unit is connected to the Ethernet network and the user has not yet entered IP address settings for that unit, that unit's factory-set IP address will be used, and that address will appear in the "Node List" shown below. Next, use the standard steps to transfer data to the desired GP unit.

The following "Node List" shows the result of a search. In this case, the GP unit found has no user-designated IP address settings and the factory-set IP address is listed.

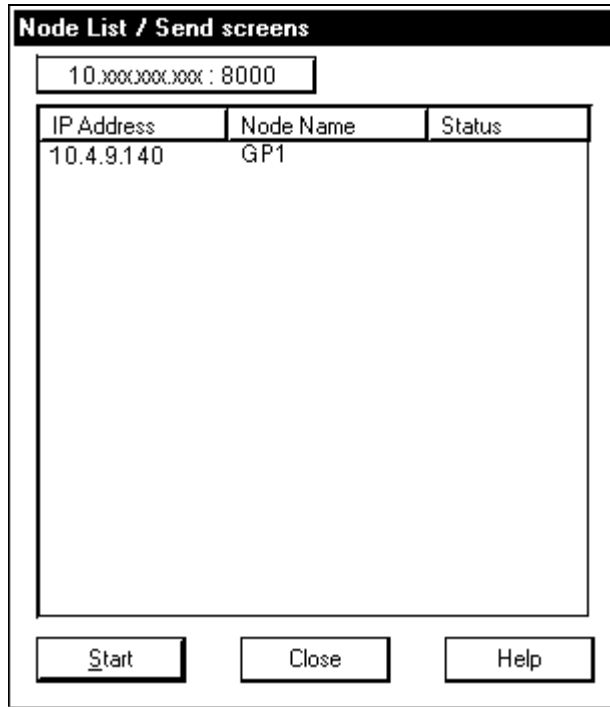

**B**efore transferring screen data to the GP unit and connecting the GP unit to the device, you can check the GP panel operation by running a simulation of your GP-PRO/PB III for Windows program.

This chapter describes the program simulation procedure.

## 8.1 ..... Overview

## 8.1 Overview

Connect the GP unit to your personal computer via the transfer cable. Turn ON/OFF bits on the GP-PRO/PB III program's Simulation screen, and change the data corresponding to the specified word address. This enables you to check the operation in the GP unit and the data changes resulting from the Tag and Part functions. In addition, the Snapshot function allows GP screens to be saved in JPEG format to the GP/GLC unit's CF Card .

**Reference** [8.1.5 Snapshot Function](#)



**The Simulation feature is provided for simulating device operations on a PC. Since this is only a simulation, its performance may differ from when the GP is connected to a Device/PLC.**



Connecting method is the same as that for data transfer.

**Reference** [7.1 Prior to Transferring Date](#)

The Simulation function can be used through the screen transfer cable that connects the PC and the GP unit, or through the Ethernet. (**Reference** [8.1.4 Simulation \(Ethernet\)](#))

### ■ Precautions

When using the Simulation function keep in mind the following restrictions:

- To carry out a simulation, you need to transfer screen data and a simulation protocol, and create simulation data in advance.
- The Simulation function is only intended for a “1:1” connection between the GP unit and your personal computer. When your personal computer is connected to more than one GP unit (“n:1”, multi-link), the simulation cannot be performed.
- When the Device/PLC type is specified as “Memory Link SIO Type” or “Memory Link Ethernet Type”, or “CC-Link Type”, the simulation cannot be performed.
- When the display address for the E-Tag or K-Tag is indirectly specified (“Indirect” is selected for the [Data Format] tab) and “Area subsequent to the display address” is specified as the indirectly-specified area, the simulation cannot be performed.

- The simulation cannot be performed for the device specified in [GP System Settings] (n:1 communication information, Watchdog, Video Control Area, Alarm Trigger Count, Extended memory device of Hitachi HIDIC SIO α, etc.)
- The simulation cannot be performed for any address greater than 32,768 (8000h). To perform a simulation for such an address, temporarily change the address to 32,767 or lower.
- The GP unit's device monitor feature cannot be used.
- Do not press any touch panel switch on the GP unit before the simulation has begun; and, do not change the screen on the GP panel. Otherwise, a system error will occur.
- If the backup function for the LS area is selected, or if a D-Script, W-tag, etc. uses an LS area special relay for its start bit, no LS device can be simulated.
- If the LS device is frequently written using the D-script during the LS device simulation, actions such as a slide transition will be slow.
- When performing simulation, please set 16 Bit for the LS device. If 32 Bit is set, the simulation cannot be performed.
- The LS device used with the Extended SIO Script cannot be simulated.
- When performing simulation on GP-377 series, GP77R series or GP2000 series, DO NOT specify [GP System Settings] - [Extended Settings] tab - [Reset GP On Data Write Error].
- When using Yamatake's SDC Series Device/PLC, deselect [GP Settings] - [Extended Settings] tab - [System Area Settings].
- When using GP77R series or GP2000 series and Mitsubishi Electric's CPU direct connection type Device/PLC (such as Mitsubishi MELSEC-AnA (CPU)), with the GP offline mode's [Setup Operating Environment] - [Built-in] selected, the simulation function cannot be used. Select [Adapter] or [Direct] and then perform simulation.
- The LS device simulation is only effective for GP-377 series, GP77R series and GP2000 series.
- The Simulation function can be used only when the LT is Type-C.
- Simulations of logic program's variables (Logic symbol) cannot be performed.
- The operation of the device connected to the Tool Connector cannot be monitored even when executing Simulation using the Ethernet or USB.

**8.1.1 General Description of the Simulation Screen**

To perform a simulation, first transfer the screen data created with the GP-PRO/PB III program and the "simulation protocol" to the GP unit.

**Reference** 7.2 Transferring Screens



**Note:** Designate the System Area settings before using the Simulation function. Click **GP Setup** and select the [Extended Settings] tab. Click on the right side "System Area..." button and specify the "Current Screen No." and "Chg.scr. (Change To Screen No.)" fields.

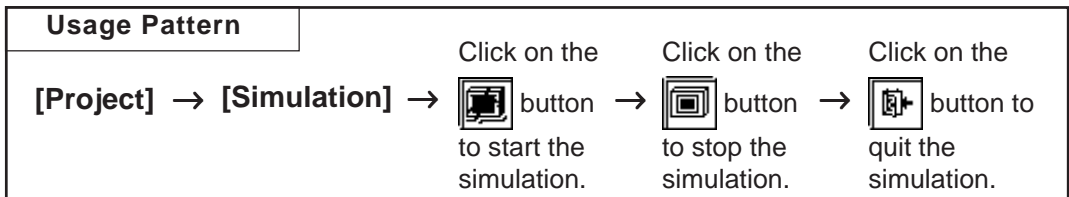

General description of the Simulation screen:

Enter the Base Screen number where device information is to be displayed

Select a function to display device information.

Displays negative values with a minus sign

Select which to screen to be displayed on the GP panel during the simulation

Selects the format of the display and input data

Starts/Stops the simulation

Blinks while the simulation is being executed

Displays the device information of Tags and Parts placed on each screen

Name/Description	Function	Address	Status	Alter	No.	System Area
N_0000	Data Storage Address	D00000	1		+00	1
K_0000	Trigger Bit Address	X00000	OFF		+01	0
K_0000	Data Storage Addr	D00001	0		+02	1
K_0001	Trigger Bit Address	X00000	OFF		+03	16
K_0001	Data Storage Addr	D00002	1		+04	41
K_0002	Trigger Bit Address	X00000	OFF		+05	4930
K_0002	Data Storage Addr	D00003	16		+06	0
T_0000	Op. Bit Addr.	X00010	OFF		+07	0
T_0001	Op. Bit Addr.	X00011	OFF		+08	0
G_0000	Data Storage Address	D00000	1		+09	0
					+10	0
					+11	0
					+12	0
					+13	0
					+14	0
					+15	0
					+16	0
					+17	0
					+18	0

Changes the device status

Changes the system status

Displays the current status of the system

◆ **Chg. Scr.**

When the  check box is marked, the GP panel screen is changed according to the Simulation screen. When this check box is , the GP's screen can be separately changed, independent of the Simulation screen.

◆ **Displayed Function Selection**

The function used to display the simulation can be changed. In addition to the settings of each screen, the devices show in the following figure that have been set with the screen-independent global functions can also be displayed.



◆ **Format**

The data format of the device status (displayed in the “Status” cell) and the device data (displayed in the “Change” cell) can be selected for “Dec” (decimal), “Hex” (hexadecimal), or “Oct” (octadecimal) format.

◆ **+/-**

Marking the “+/-” check box adds a “- (minus)” sign to the displayed values, if the word address settings displayed in the “Status” cell are negative values.

◆ **Tag Name/Comment**

The Tag name (or ID number of a Part) or any comment is displayed. To switch the Tag name or comment display mode, select [Tag Name] or [Comment] from the [View] menu.

◆ **Function**

A general description of the device function for each specified Tag or Part is displayed.

◆ **Address**

The device specified for each Tag or Part is displayed and you can change their word address settings.

◆ **Status**

The current status of each device (bit ON/OFF status or word address setting) is displayed, and you can change their word address settings.

◆ **Alter**

You can change each device status (bit ON/OFF) or the word address settings.

Every time you click on the  icon, the bit ON/OFF status is switched.

When you click on the  icon, the following Keypad will appear, enabling you to change the data.

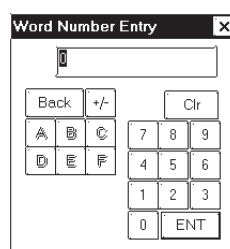

◆ **No.**

You can change the status (settings) of the system data when you click on the  icon. A Keypad will appear, enabling you to enter desired number changes.

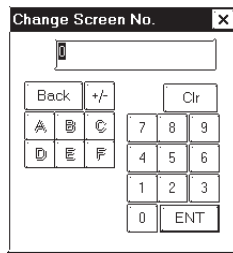

◆ **Area**

The current status (settings) of the GP unit' system data area is displayed, and you can change these settings by directly entering new data.

■ **Selecting a Display Type**

Select the types of Tags and Parts used to display device information. Select the [Options] menu - [Display Type Settings] command.

Specify the Tags and Parts to be displayed.

When you select "All Type", information on all Tags and Parts will be displayed.

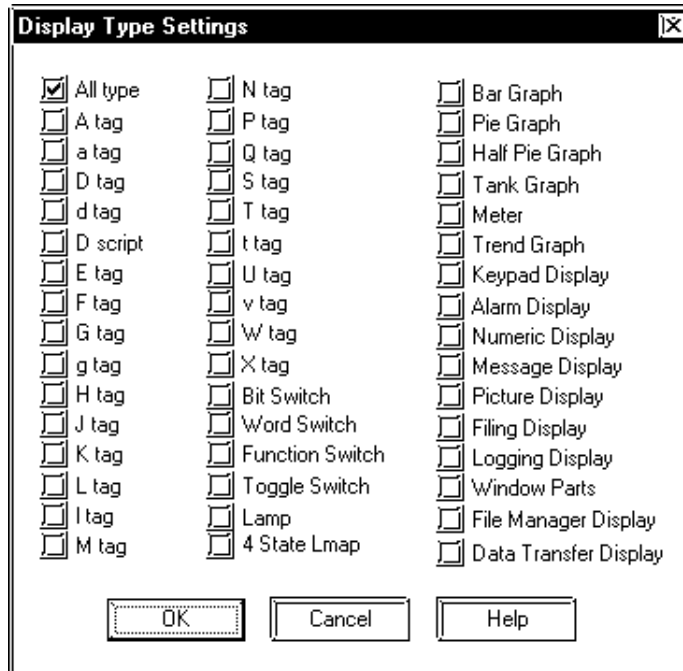



### ■ Setting up the Device Memory

Even after the simulation function has been closed, device information can be saved to the Project File.

Select the [Options] menu - [Device Memory Settings] command.

When the “Backup” check box is marked  , device information is automatically saved when the simulation function is quit. When the simulation starts up again, the same device status will be displayed.

Clicking on the  button resets all device settings to “0”.

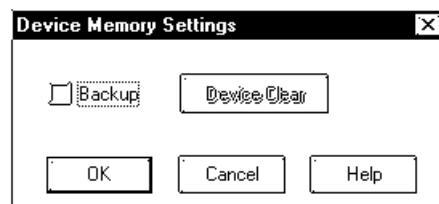

### ■ Movement Settings

If your GP unit type is a GP-377, GP-7R or GP2000 series unit, LS devices can also be simulated in the range from LS0020 to LS2031 (excluding the read-in area) and LS2096 to LS4095 (LS2096 to LS8191 for GP-2000 series unit). Select the [Movement Settings] command from the [Option] menu.

If the [LS Device] check box is marked, the tags and parts that use LS devices will be displayed when a simulation is executed.

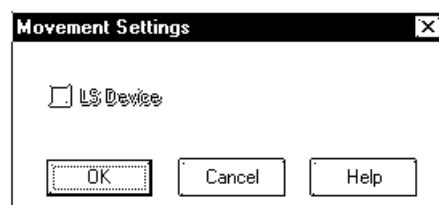

**To use the Snapshot function, enable "LS Device Simulation" by checking the check box.**

**Reference** 8.1.5 Snapshot Function

## ■ Address Registration

Simulation can be performed for any registered address, not for each screen or function.

The simulation result is displayed by selecting the registered address from the display function pull-down list's [Address Registration].

To register/edit an address, select the [Simulation] menu - [Address Registration] command.

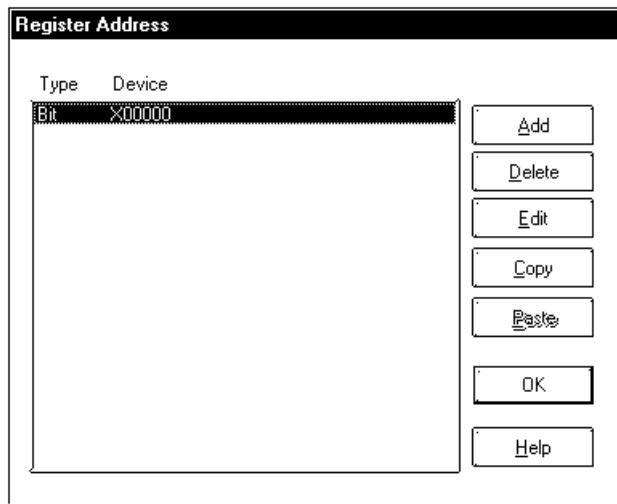

**Note:** The address to be entered varies depending on your GP and PLC type. Note that the sample screen in this manual is just one example.

### ◆ Adding a registered address

You can add a new address. Click on the  button, and the following dialog box will appear. Then, enter an address and the number of addresses to be added, and specify Bit or Word.

After entering a number of addresses to be added, addresses are added from the designated number in series.

You can enter a desired name as a function name with up to 20 half-sized characters.

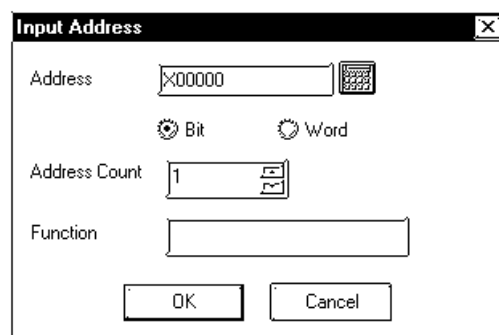

### ◆ Editing a registered address

You can change the registered address settings. Select an address to be edited and click on the  button. Then, a dialog box that is the same as for the adding of a registered address will appear.

**◆ Deleting a registered address**

You can delete a registered address. Select an address to be deleted and click on the  button. Then, a dialog box will appear to confirm the command. If you execute the delete command, click on the  button, and if you cancel it, click on the  button.

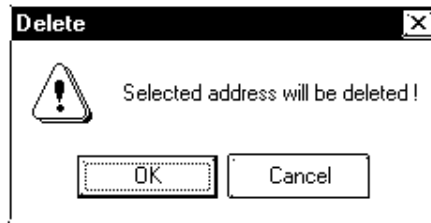
**◆ Copying and pasting a registered address**

Select an address to be copied and click on the  button. Then, click on the  button to add the copied address at the end of the list.

## 8.1.2 Transferring Simulation Protocol

To simulate the GP panel’s actual operation using the GP-PRO/PB III program, transfer the screen data created with the GP-PRO/PB III program along with the “simulation protocol” to the GP unit.

**Reference** 7.2 Transferring Screens

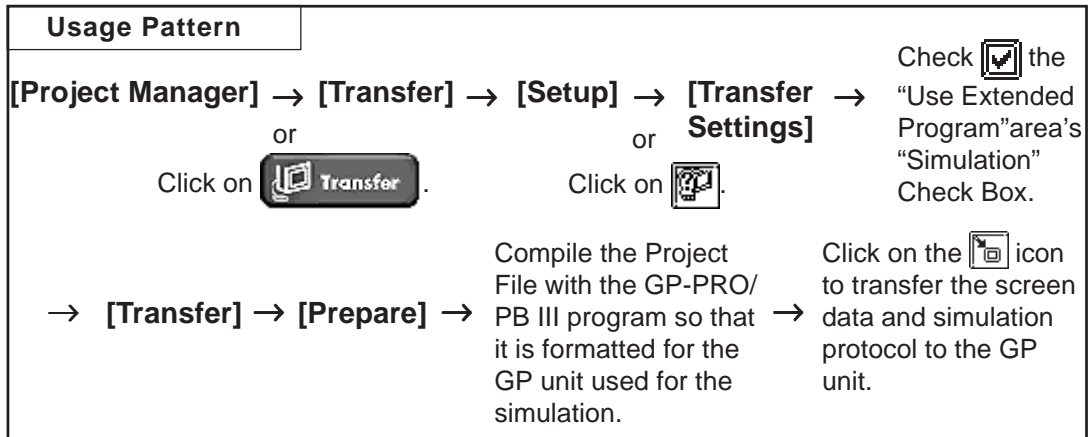

### ■ Simulation Protocol

Before executing the simulation, you must first transfer the simulation protocol to the GP unit, regardless of the Device/PLC type specified for the project file.

Check the “Use Extended Program” area’s “Simulation” Check Box in the [Transfer Settings] dialog box so that when screens are transferred, the simulation protocol will be transferred to the GP unit.

**Reference** 7.2.1 Transfer Settings



**If you are using a GP70 Series unit, normal communications with the device cannot be carried out with the simulation protocol. To re-establish the link with the device after executing a simulation, be sure to send the GP Unit communication protocol for the device type, and then re-set the GP unit.**



- When a simulation is executed with the GP77R series or GP2000 series, you need to transfer the simulation protocol only for the first screen transfer.
- If you are using a GP other than GP77R or GP2000 Series unit, “Set Up Operation Surroundings” in the GP unit’s PLC setup menu cannot be used while the simulation protocol is transferred.

### 8.1.3 Performing a Simulation

To perform a simulation, first connect the GP unit to your personal computer using the Data Transfer Cable.



**Important**

**Before performing a simulation, you must transfer the simulation protocol to the GP unit.**

**Reference** 8.1.2 Transferring Simulation Protocol

Personal Computer (PC)

GP screen transfer cable

GP

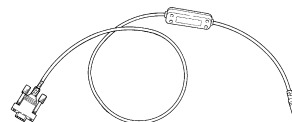

To the PC's  
serial port

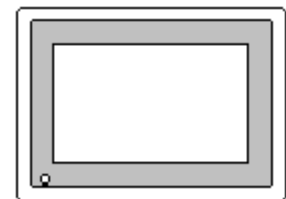

To the Tool Connector

### ■ Performing a Simulation

#### PROCEDURE



Connect the GP unit to your personal computer with the Data Transfer Cable.

1) Via the Project Manager, select the [Project] menu - [Simulation] command, or click on the  icon.

2) Click on the  button to begin communication with the GP unit.

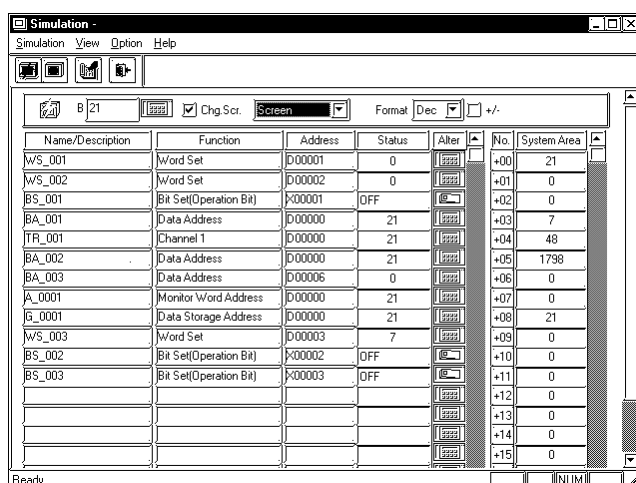
The device information on the current GP panel screen is displayed.





You can check the GP panel operation by switching screens or changing the device settings using the  or  icon displayed in the [Alter] cell. Also, you can check the device status changes via the GP's touch keys.

#### REMARKS

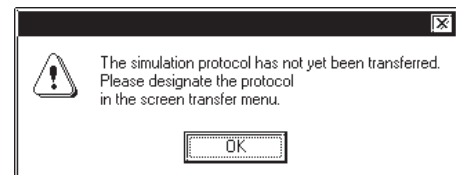

Prior to starting simulation, set the GP unit to the RUN mode.

If the simulation protocol has not been transferred to the GP unit in step (1), the following dialog box will appear, and the simulation cannot be started.



During communication, the  icon blinks, like this .

**Reference** 8.1.1 General Description of the Simulation Screen

PROCEDURE	REMARKS
<p>3) Click on the  button to quit the simulation.</p> <p>4) Click on the  button to quit the simulation mode.</p> <p>With the GP70 series, when you quit the simulation mode, the system asks if you wish to again set up the GP unit for communication with the device.</p> <p>If you select <input type="button" value="Yes"/> , the system will set up the GP Unit. If you select <input type="button" value="No"/> , the system returns to the Project Manager without setting up the GP Unit.</p> <div data-bbox="301 665 734 1037" style="border: 1px solid black; padding: 5px; margin: 10px 0;"> <p><b>Simulation</b></p> <p>Reverting to original protocol file.</p> <p>Do you wish to continue?</p> <div style="border: 1px solid black; height: 80px; width: 100%;"></div> <p><input type="button" value="Yes"/> <input type="button" value="No"/> <input type="button" value="Help"/></p> </div> <p style="text-align: center;">↓</p> <div data-bbox="376 1155 810 1532" style="border: 1px solid black; padding: 5px; margin: 10px 0;"> <p><b>Simulation</b></p> <p>Finished.</p> <div style="border: 1px solid black; padding: 2px;"> <p>Transferring loader program ...</p> <p>Handshaking ...</p> <p>Downloading protocol file ...</p> <p>Please do not turn off GP</p> <p>Binary transferring ...</p> <p>Binary transferring ...</p> <p>Resetting GP ...</p> <p>--- End System Setup ---</p> </div> <p style="text-align: center;"><input type="button" value="Ok"/></p> </div>	<p>During simulation, screen data cannot be transferred. Click on the  icon and stop simulation before transferring screen data.</p> <p><b><i>Simulation protocol cannot be used for normal communication with a device. To re-establish the link with the Device/PLC after executing a simulation, be sure to send the GP Unit communication protocol for the Device/PLC type, and then re-set the GP unit.</i></b></p> <p><b><i>When using a GP77R or GP2000 series unit, you do not need to set up your GP unit again.</i></b></p>

### 8.1.4 Simulation (Ethernet)

You can also perform a simulation connecting the GP and your PC (running GP-PRO/PBIII) via an Ethernet network.

#### ■ Simulation via an Ethernet Network

Only GP2000 Series units can use this function.



- Using the function with the GP-2501 and GP-2601 requires a large-scale Multi Unit E or a GP Ethernet Interface unit.

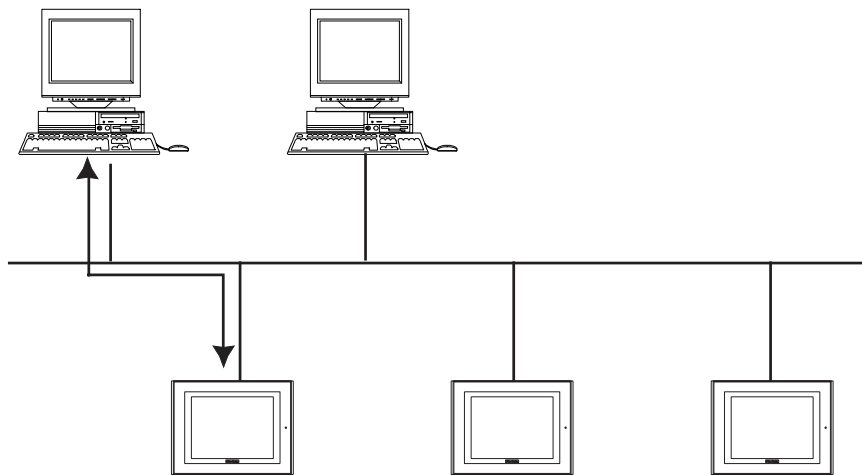

- The GP-2301H, GP-2401H, GP-2301 and GP-2401 cannot be connected to an Ethernet network.

The simulation function using Ethernet provides the same level of functionality as when using the data transfer cable. The limitations for this feature are the same as for the transfer cable.



- *To perform a simulation, download the screen data and the special simulation protocol to the GP via the Ethernet network.*
- *Simulations via Ethernet and the transfer cable cannot be performed simultaneously.*
- *LS device simulation can be also performed.*
- *When using the simulation function, do not transfer screens to the GP.*

### ■ Transfer Setting Dialog Box

Whether the simulation is performed through the serial port or through Ethernet is determined in the transfer setting dialog box in the [Transfer Screen].

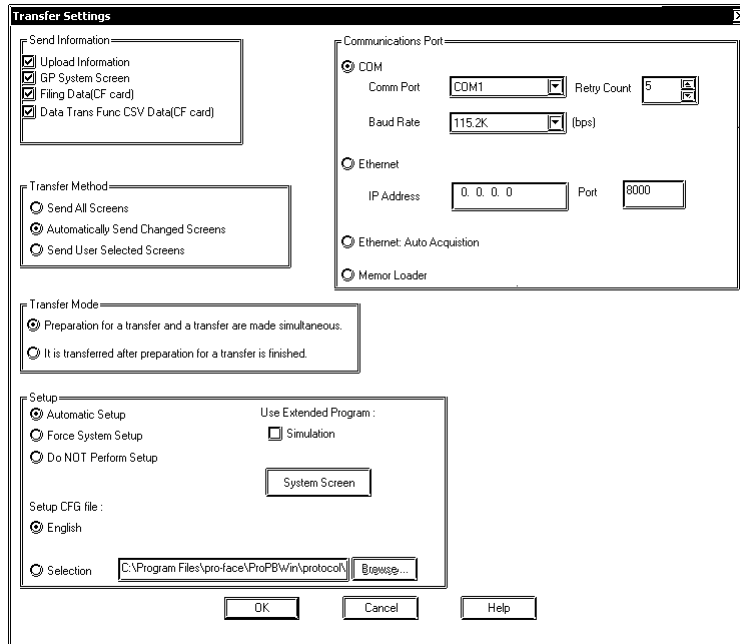

COM: Via serial port  
Ethernet: Via Ethernet

### ■ Selecting the GP

To begin the simulation, click on the  icon, or select the Simulation feature from the [Project] pull-down menu. When the start button is clicked, the connected GPs will be listed.



- The simulated communication via Ethernet can be performed with only one GP selected from the node list.
- Multiple GPs cannot be selected in the node list.





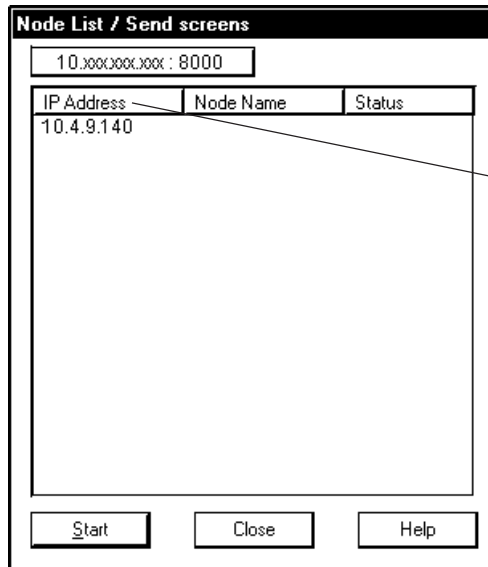

After you select a GP from the list and click the Start button, the node list dialog box will close and the simulation screen will appear.

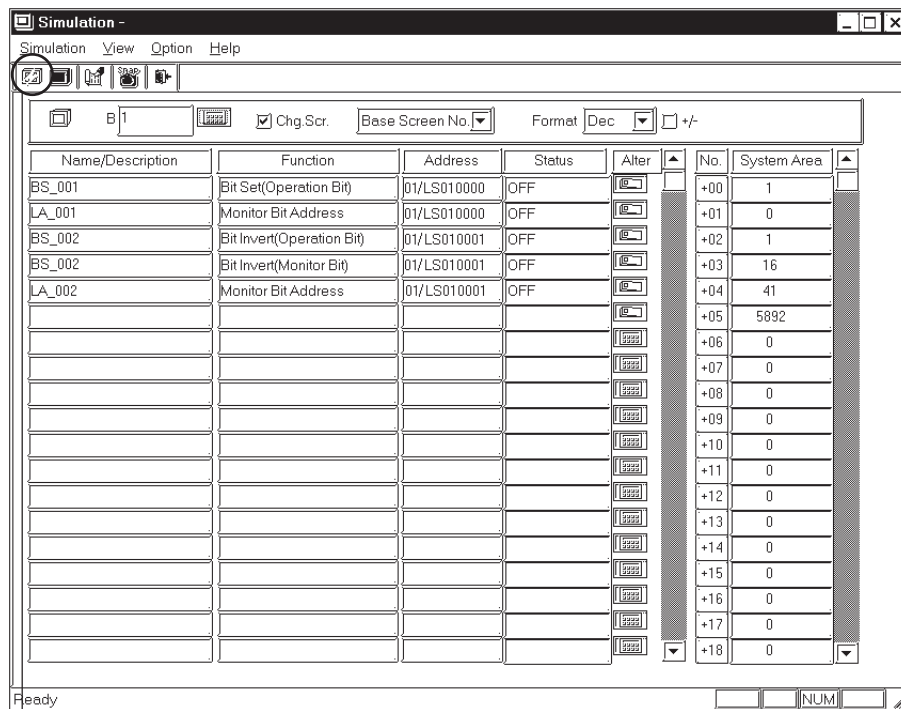

Click on the start button to begin searching for all GPs connected to the Ethernet network. All connected GPs will be appear in the node list.



- Note:**
- If you stop the simulation and then click the [Start] button again, the node list will be displayed again.
  - While the simulation is being performed, the target GP cannot be changed.
  - To use the factory-set IP address, the IP address and the subnet mask in the PC should be changed.

### 8.1.5 Snapshot Function

This feature allows Simulation screens of the GP to be written onto a CF Card in JPEG file format with the ease of taking a snapshot.



- **A CF Card is required to use the Snapshot function.**
- **This function is available only with the GP2000 series.**

#### ■ Performing a Snapshot Function

PROCEDURE	REMARKS
<p>(1) Perform a simulation.</p> <p>(2) When the screen to be simulated is displayed on the GP screen, select [Snapshot] from the [Simulation] menu on the "Simulation" screen or click  on your PC screen (GP-PRO/PB III).</p> <p>The JPEG file captured with the snapshot function is automatically stored on the CF Card attached to the GP unit. The complete operation takes five or six seconds.</p>	<p><b>Reference</b> 8.1.3 <i>Performing a Simulation</i></p> <p>Enable "LS Device Simulation" in the Movement Settings.</p> <p><b>Reference</b> 8.1.1 <i>General Description of the Simulation Screen</i> ■ <i>Movement Settings</i></p>

#### ■ JPEG File Name

JPEG files are automatically assigned a file name according to a numerical sequence. The file name of a saved JPEG file will be "\CAPTURE\CPXXXXX.JPG" (XXXXXX is a number from 0 to 65535, assigned sequentially). The number is automatically incremented by one (XXXXX) from the largest file number existing on the CF Card. The Snapshot function is disabled when the number sequence exceeds "65535" or the free space on the CF Card is insufficient.

#### ■ Reverse Black & White

When the "Reverse Black & White" feature is enabled under the Screen Capture function ( **Reference** *Tag Reference Manual, 4.7.10 Screen Capture*), black and white are reversed in the snapshot image of the simulation. **Reference** *Tag Reference Manual, 4.7.10* ◆ *Black/White Reverse*

**■ Snapshot Errors**

The following error messages are displayed on your PC when CF Card errors occur during the Snapshot operation. If a warning is displayed, no JPEG file is created on the CF Card.

Error Message	Error Conditions
No CF Card is inserted in the GP.	-No CF Card is inserted. -The CF Card cover is not completely closed.
The snapshot cannot be written to the CF Card inserted in the GP.	-Insufficient free space remains on the CF Card. -The CF Card was removed while data was being saved.
Invalid CF Card is inserted in the GP.	-An operation failure has been detected with the CF Card, or the CF Card is unformatted.

# *Memo*

**A** printed copy of created screens and Tag designation status is often useful when debugging. This chapter describes the printing procedure and print settings.

9.1	.....	<b>Print Settings</b>
9.2	.....	<b>Sample Printer Output</b>

# 9.1 Print Settings

This section describes the procedure for printing created screens or a list of specified Tags, and options available when printing.

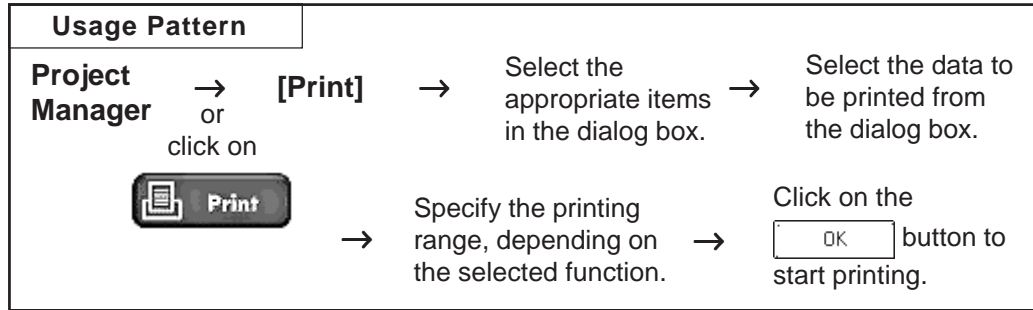

## 9.1.1 Printing

When you select the [Project] menu - [Print] command, the [Print] screen will be displayed.

### ■ Printing - [Print] Tab

Specify the printer type and other print settings on your personal computer. Only Windows-compatible printers that can be connected to your personal computer can be used to print with GP-PRO/PBIII for Windows.

**Displays the printer name specified on your personal computer**

**Click on this button to display the Cover Page dialog box**

**Comments on the data printed can be entered to be printed out along with the data. To print comments, check this box; to display the Comment Information dialog box, click on the "Detail" button**

**Click on this button to display the [Options] dialog box**

**Displays the printing-related [Property] dialog box**

**If this box is checked, instead of printing a hard-copy, the data is saved as a RTF text file (\*\*.RTF), and can be edited with other text editing software**

**Enter the number of copies to be printed; the default setting is 1**

**Select the Text Table to be printed.**

**A cover page with a title, company name, date/time, name, and a bit map can be included with the document. To print a cover page, check this box**

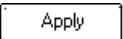

- The printing setting information can be saved by clicking on the  button.
- The printing orientation is "Vertical" (Portrait).
- Only "A3", "B4", or "A4" paper can be used for printing.

◆ Cover Page Dialog Box

Check this box to print a title on the cover page

Enter a title or a company name of up to 3 lines (40 characters per line)

Check this box to include the date and time of printing on the cover page

Check this box to include a Bit-map on the cover page

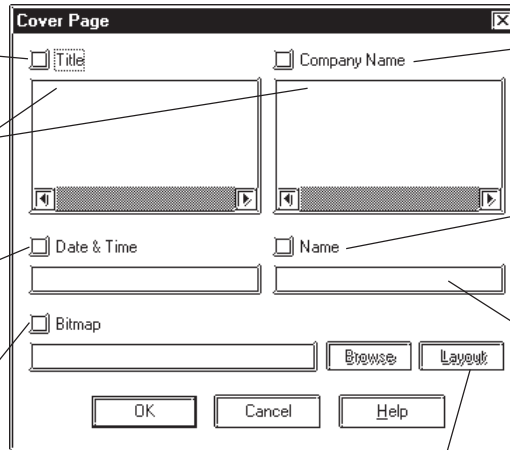

Check this box to print a company name on the cover page

Check this box to print a name on the cover page

Enter the name here

Click on this button to preview the cover page layout. When Bit-map printing is selected, the placement of the Bit-map on the cover page can be changed.



• If a Bit-map is pasted on the cover page, a 24-bit color Bit-map cannot be used.

◆ Comment Information Dialog Box

Enter a comment of up to 40 lines (80 characters per line)

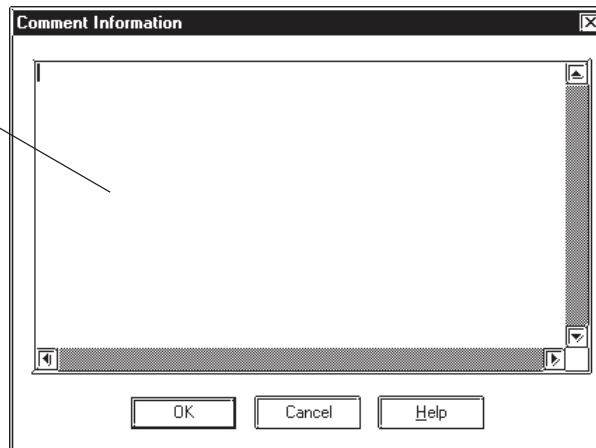

◆ Options Dialog Box

Settings in the Options dialog box allow you to format the pages of the document to be printed. You can specify the range of page numbers to be printed, the screen color, and margin size.

Prints the black/white-reversed screen color

Check this box to print the page number on each page of the document

When printing page numbers, specify if the cover page is to be numbered

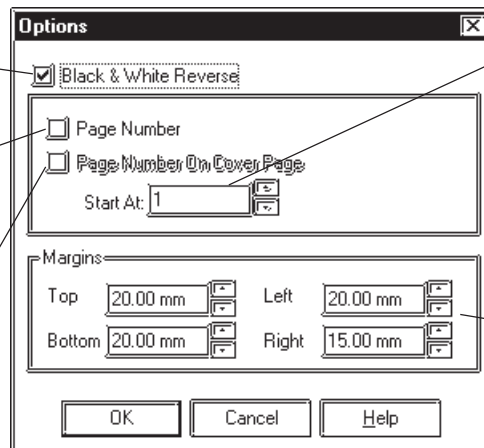

Enter the initial page number to be printed on the first page of the document

Specify the upper, lower, right and left margin sizes

### ■ Printing - [Project Information] Tab

You can check the created screens and Tag designation status through printer output.

Prints a project information summary list

Prints the list of settings of the item marked with a check.

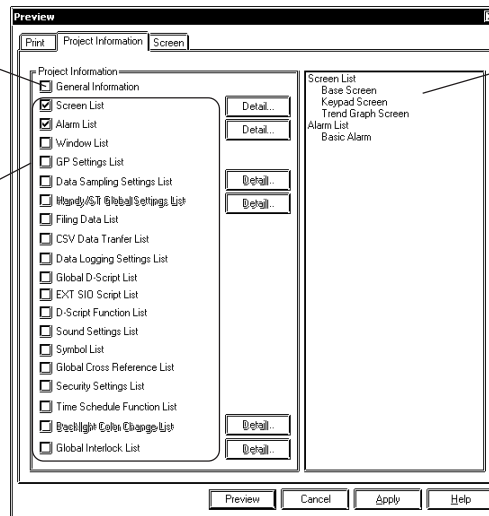

Displays the currently-selected item

### ◆ Details

Click on the  button to specify detailed information of printing.

#### Screen List

Select the screen type to be printed.

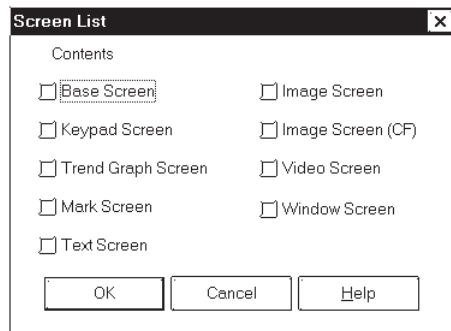

#### Alarm List

Select the alarm type to be printed.

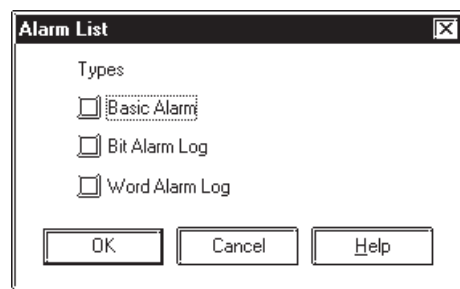

#### Date Sampling Settings List

Select whether to print the summary or details of the data sampling settings.

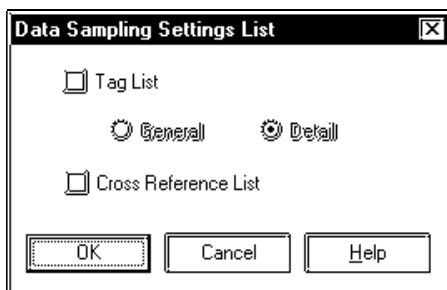

#### Global Setting List

Select whether to print the summary or details of the Handy-type GP/ST Series global settings.

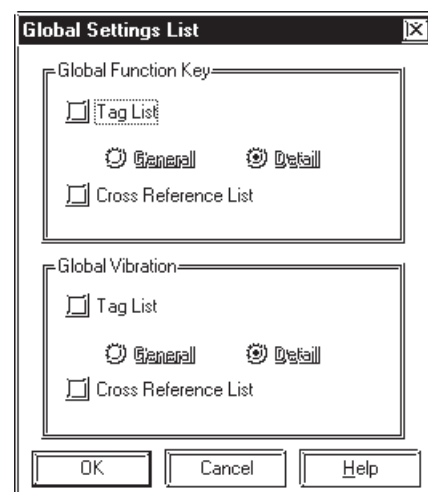



**Backlight Color Change Settings List**

Select the print option from the Overview and Details of the Backlight Color Change settings.

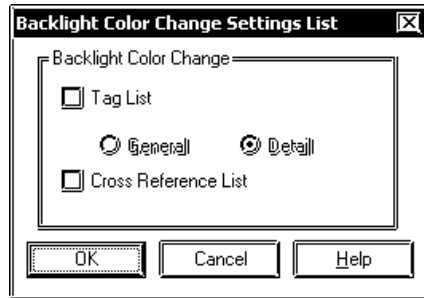

**Global Interlock Settings List**

Select the print option from the Overview and Details of the Global Interlock settings.

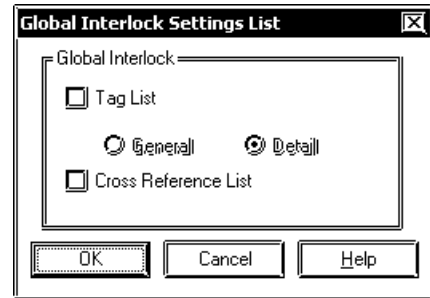

**■ Printing - [Screen] Tab**

Select the screen type and contents to be printed.

Select the screen type to be printed

Specify the printing range by screen numbers. When you select [All (A)], all screens will be printed.

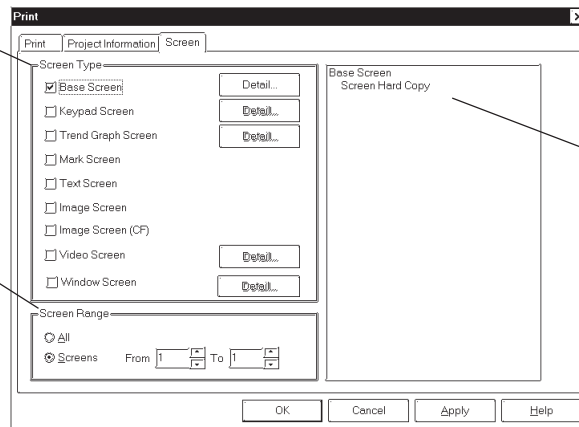

Displays the currently-selected item

◆ **Details**

Click on the  button to specify detailed information of printing.

**Base Screen**

Specify the printing items related to a Base Screen.

The 'Base Screen' dialog box contains the following elements and annotations:

- Contents:**
  - Load Screen List (Annotation: Prints a list of the screens loaded onto a specified screen)
  - Tag List (Annotation: Prints a list of the specified Tags. Select whether to print the summary or details of the Tag list)
  - Parts List (Annotation: Prints a list of the Parts placed on the Base Screen. Select whether to print the summary or details of the Part list)
  - Cross Reference List
  - D-Script (Annotation: Prints the D-Script settings)
- Buttons:**
  - Screen Hard Copy (Annotation: Outputs screen hard copies. The printing items can be specified)
  - Tag Mark
- Information character:**
  - Tag Name
  - Object ID No.
  - Device Address
- Information character size:**
  - Normal (Annotation: Select Information cahacter's printing size. When selecting [Small], 1/4-sized characters are used)
  - Small
- Other options:**
  - Border
  - Window Mark
  - Window Parts
  - Grid
  - State:  On  Off (Annotation: When making a screen hard copy, The Parts' ON/OFF status can be specified. The same status is specified for all screens to be printed)
  - State0 (dropdown menu)
- Buttons:**

**Reference** 2.9.7 Cross Reference List



**Note:** When the summary of the Part list is printed, its right edge may get outside the paper. In this case, open the Option dialog box by clicking on  button in the [Print] tab, and then reduce the left margin.

**Keypad Screen**

Specify the printing items related to a Keypad screen.

The 'Keypad Screen' dialog box contains the following elements:

- Contents:**
  - Load Screen List
  - Tag List
  - Screen Hard Copy
  - Tag Name
  - Tag Mark
  - Border
  - Grid
- Buttons:**

**Trend Graph Screen**

Specify the printing items related to a Trend Graph screen.

The 'Trend Graph Screen' dialog box contains the following elements:

- Contents:**
  - Load Screen List
  - Tag List
  - Screen Hard Copy
  - Tag Mark
  - Border
  - Grid
- Buttons:**

**Video Screen**

Specify the printing items related to a Video screen.

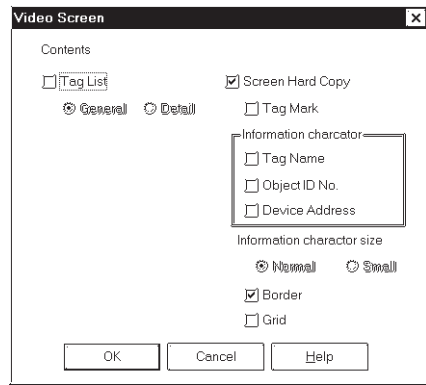

**Window Screen**

Specify the printing items related to a Window screen.

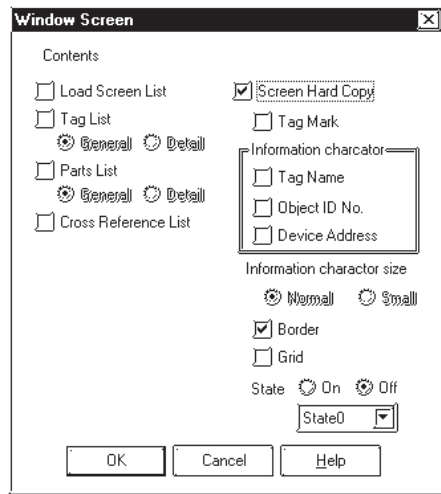

## 9.1.2 Print Preview

By selecting the [Project] menu - [Print Preview], you can preview the screen image to be printed.

Setting items are the same as those of printing. Instead of clicking on the

button, click on the  button.

### Print Preview Screen

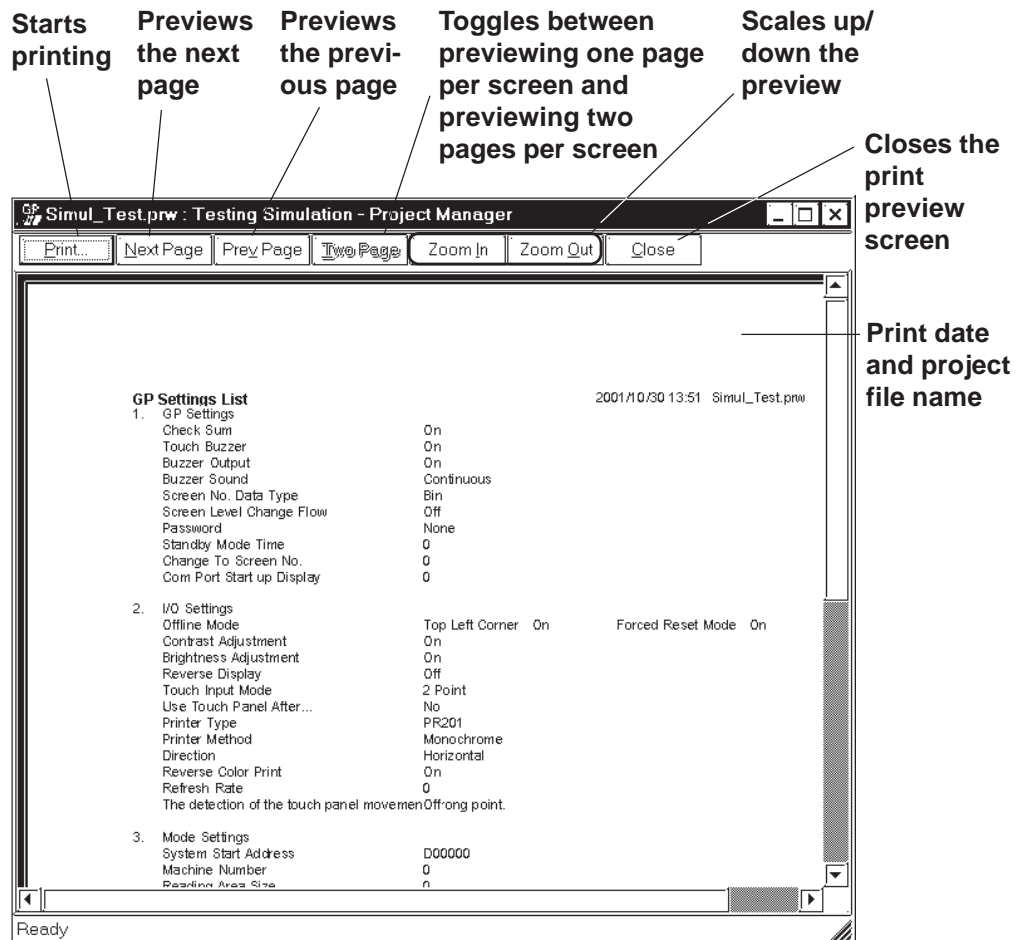

## 9.2 Sample Printer Output

This section provides sample printing of various data such as a created screen or a list of specified Tags.

The following data can be printed.

### ■ Printing

#### ◆ Cover Page

Select whether the cover page is to be printed or not.

#### ◆ Comment Information

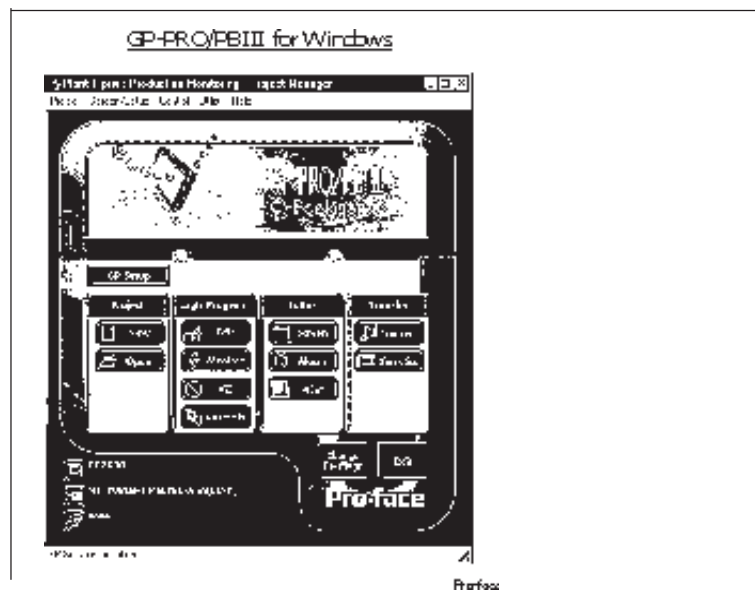

Select whether comment information is to be printed or not. Comment information is a function to add supplemental information to the printed data. Up to 40 lines of 80 characters can be entered.

### ■ Project Information

#### ◆ Summary

Prints a project summary list.

Project Information	1338/12/ 4 15:02 Factory B - 470 Test.prw
<b>General Information</b>	
Project Name	Factory B - 470 Test.prw
Description	470 test
Project Size	587 Bytes
Type	GP70
PC Type	MITSUBISHI MELSEC-A(NLINK)
Project Size	100 Bytes
Date	Fri Dec 04 14:09:12 1998
Device/Monitor Information	None

◆ **Screen List**

Prints a list of the screens of a specified type.

Screen List		1999/12/ 4 15:08 Factory B - 4FD Test.pnw	
Screen	Description	Date/Time	
01	Base Screen		
01	First Screen	12/4/98 15:07	
01	Operation Monitor	12/4/98 15:08	
02	Allocate Summary	12/4/98 15:08	
03	Trouble	12/4/98 15:08	
04	Head Input	12/4/98 15:08	
05	State Switch	12/4/98 15:08	

◆ **Alarm List**

Prints a list of the created alarms.

Alarm List		1999/12/ 4 15:26 Factory B - 4FD Test.pnw	
No.	Bit Address	Group	Sub Display
1	000100 Pmp 3 ON	0	0
2	000101 Pmp 2 ON	0	0
3	000102 Pmp 1 ON	0	0

◆ **Registered Window List**

Prints the window registration status.

Window List				
Window	Screen	Position	Size	Title
1	01	(176, 671)(423, 264)	248x198	Locoma Window
2	01	(56, 193)(136, 286)	80x94	Bit Switch Window

◆ **GP System Setting List**

Prints the GP system settings.

2. I/O Settings	
Offline Mode	Top Left Corner On/Forced Reset Mode On
Contrast Adjustment	On
Brightness Adjustment	On
Reverse Display	Off
Touch Input Mode	2 Point
Use Touch Panel After...	No
Restoration Check	No
Printer Type	PR201
Printer Method	Monochrome
Direction	Horizontal
Reverse Color Print	On
Refresh Rate	0
Touch Panel Error Detection	Off

◆ **Data Sampling Setting List**

Prints the data sampling settings.

Data Sampling Settings List	
Detail of Tags Setting	
Setup Channel	
Name	00001
Description	Data Sampling
Sampling Address	0000
Trigger Bit Address	X000
To Write Address	13000
No. of Sampling Addr.	1
Data Backup	No
Synchronous Mode	- - -
Sampling Type	Period. No
Sampling Time	60
Sampling Monitor Address	- - -

◆ **Global Setting List  
(Function Keys)/(Vibration)**

```

Global Function Settings List
-----
Tag List
T_Tag
Name Fn Key Description Mode Op. Bit Addr. Op. Word Addr. Calc. Data Addr.
_0000 F1 Bit Set X00000 - - - -

t_Tag
Name Fn Key Description Op. Bit Addr.1 Op. Bit Addr.2
_0000 F9 X00000 X00000

k_Tag
Name Fn Key Description Mode Character Screen Number
_0000 F14 Convert Text Input - - - - -

Global Vibration
Name ---
Comment test2
Mode Bit
Address X00001
Trigger 0->1
Alarm - - -
Alarm - - -
Vibration time 10
Buzzer OFF

Cross Reference List
Bit Address Tag Name Parts ID
X00000 Global Vibration
X00001 Global Vibration
    
```

Prints the global settings.  
The vibration feature is only available on Handy-type GP2000 Series units.

◆ **Filing Data Setting List**

```

Filing Settings

Filing (ON/OFF) On
Use Multiple Folders Off
Control Word Address D 00000
Write Completed Bit Addr X 00000
PLC Controlled Transfer Off
    
```

Prints the Filing Data settings.

◆ **CSV Data Transfer List**

```

Data Transfer Function 2003/05/23 17:18 aaaaaa.pro

Control Address D 00000

Description
State No. 0
Word Address D 00000
No. of Data Item 10
Data Format 16 Bit: +/-
File No. 0 - 65535
Auto Number 0 FF
    
```

Prints the CSV Data Transfer settings

## ◆ Data Logging Settings

```

Data Logging Settings List
Data Logging Settings
Trigger Settings      Bit Method
Data Logging Start Address  D000
No. of Words         1
Read Count           1
Block Count          1
E/C Trigger Bit Address X000
CP ACK Bit Address   X000
File Full Bit Address X000
Data Clear Bit Address X000

Display              On
Row Settings
Display Block Name   On
No. of Block Name Rows 2
No. of data Rows     2
No. of Calc. Rows    1
Column Settings
Display Block Name   On
No. of Char./Item    5
No. of Data Col.     3
Data Char. Size      1x1(f)
No. of Char. Data    8

```

Prints the data logging settings.

## ◆ Global D-Script List

```

Global D-Script List
D-Script
Identifier 00001
Description Global D-Script Test
Data Type Bin Length 16 bit Signed Unsigned
Trigger Bit Rising ()
Action if ()
{
}
endif

Identifier 00002
Description Global D-Script2
Data Type Bin Length 16 bit Signed Unsigned
Trigger Bit Falling ()
Action if ()
{
}
endif

```

Prints the Global D-Script settings.

## ◆ D-Script Function List

```

D-Script
Identifier 00004
Description Handy D-Script
Data Type Bin Length 16 bit Signed Unsigned
Trigger Bit Rising ()
Action if ()
{
}
endif

```

Prints the D-script function settings.



◆ Sound Setting List

```

Sound Settings List

No.1
Bit Address      X000
Sound No.        Y (Internal)
Compress         Not Compress
Raw/Stoo         Raw/ON
Title

No.2
Bit Address      0002
Sound No.        Y (Internal)
Compress         Not Compress
Raw/Stoo         Repeat/ON
Title
    
```

Prints the sound settings.

◆ Symbol List

```

Symbol List

Word Symbol
A Line (1 -5)    D00100
A Line (6 - 10)  D00101

Bit Symbol
B Line (1 - 5)   X00100
B Line (6 - 10)  X00101

Word Comment
D00101           A Line Operating
D00100           A Line Stopped
    
```

The Symbol Editor's Symbol setting status is printed out.

◆ Global Cross Reference List

```

Global Cross Reference List

Bit Address      Screen
-----
X00000          B1, bit log
X00022          B4
X00023          B5
X00100          alarm message
X00101          alarm message

Word Address     Screen
-----
D00000          data sampling
D00001          B1, B2
    
```

The entire Project's address designation status, such as via Tags, are printed out. This command is executed for all the screens in the Project.

◆ Security Settings List

```

Security Settings List

Use Security Level      0 n
Password
Level1                  01b0c000
Level2                  ----
Level3                  ----
Level4                  ----
Level5                  ----
Level6                  ----
Level7                  ----
Level8                  ----
Level9                  ----
Level10                 ----
Level11                 ----
Level12                 ----
Level13                 ----
Level14                 ----
Level15                 ----
Specify Password Level15 when searching 0 (off)time
Cancel Use Bit
Use Modification Bit    0 ff
Use Bit Address         ----
Auto Clear Time (Pass)  5
Password Input Key Board
Default Settings       Numeric Key Board
Request Level Display   0 ff
    
```



**Note:** • Viewing or printing out the [Screen List] enables you to check the security level set for each Base (B) and window (U) screen. (When Security feature is enabled.)

◆ **Time Schedule**

```

Time Schedule Function List

No.1
Operation Mode      Bit Set
Operation Address   X 00000
Type               Direct
Time Setting Address -----
Start Time         08:00:00
End Time           07:00:00
Day                Sun Mon Tue Wed Thu Fri Sat
Bit Mode           -----
Start Value        -----
End Value          -----
Prohibit Operation Bit -----
Power On           On

No.2
Operation Mode      Word Set16
Operation Address   D 00000
Type               Indirect
Time Setting Address -----
Start Time         -----
End Time           -----
Day                Dec
Bit Mode           Dec
Start Value        0
End Value          0
Prohibit Operation Bit -----
Power On           On
    
```

◆ **Backlight Color Change Settings List**

```

Backlight Color Change Settings List

Detail of Tags Setting

Backlight Color Change

Name          ---
discription   Condition-Bit01
Mode          Bit
Address       X00000
Address       - - -
Change conditions Bit ON
Alarm         - - -
Alarm         - - -

Name          ---
discription   Condition-Word01
Mode          Word
Address       - - -
Address       D00000
Change conditions - - -
Alarm         10
Alarm         90
    
```

Prints a list of the current Backlight Color Change settings.

◆ **Global Interlock Settings List**

```

Global Interlock Settings List

Detail of Tags Setting

Global Interlock

Name          ---
discription
Address       X00000
Touch available condition  Bit ON
    
```

Prints a list of the current Global Interlock settings.

■ **Screen Information**

◆ **Loaded Screen List**

Prints a list of the screens loaded onto a specified screen.

```

Screen List

1) Base Screen
Screen Description _____ Date/Time _____
BI Start Up Screen 2/1/99 15:21

2) Keypad Screen
Screen Description _____ Date/Time _____
K5 Load Screen Test 2/1/99 15:56

3) Trend Graph Screen
Screen Description _____ Date/Time _____
T1 Trend Graph 12/9/98 18:41

4) Mnk Screen
Screen Description _____ Date/Time _____
M1 Mnk Screen 2/1/99 15:45
    
```

◆ **Tag List**

```

Screen Information 888/12/ 4 15:39 BI
Screen Name Factory B - 401 Test num
Screen BI First Screen

Tag List

A Tag
Name Description WhitonWord Address _____
G000 Alarm 1 0000

C Tag
Name Description Data Storage Address Graph Type Display Direction _____
G000 Rmp S ON 0000 Bar Up
    
```

Prints a list of specified Tags.

◆ **Parts List**

Screen Information							088/12/ 4 15:41 B1
<b>Plant Name</b>	Factory B - 4th Test new						
<b>Screen</b>	B1 First Screen						
Parts List							
Bit Switch	Description	Dev. Addr.	Mbit	Mbit_Adr.	Func.	Interlock_Adr.	
BS_001		X000	Off	- - -	Bit Set	- - -	
BS_002	Part ID ON	X000	Off	- - -	Bit Set	- - -	

Prints a list of the Parts placed on a Base Screen.

◆ **Cross Reference List**

Screen Information				088/12/ 4 15:42 B1
<b>Plant Name</b>	Factory B - 4th Test new			
<b>Screen</b>	B1 First Screen			
Cross Reference List				
Bit Address	Tag Name	Parts ID		
X000	K0000/K_0001,T_0000,T_0001	BS_001,BS_002		
Word Address	Tag Name	Parts ID		
0000	G0000/K_0000,K_0001,A_0000			
X000	K0000/K_0001,T_0000,T_0001	BS_001,BS_002		

Prints the address designation for Tags. This function can be executed for several screens.

◆ **D-Script**

DScript						
Identifier	00001					
Description	Warning View					
Data Type	Bin	Length	16 bit	Signed	Unsigned	
Trigger	Bit Rising ([bM0001])					
Action	if ( ) { } endit					

Prints the D-Script settings.

◆ **Screen Hard Copy**

Screen Information		088/12/ 4 15:44 B2
<b>Plant Name</b>	Factory B - 4th Test new	
<b>Screen</b>	B2 Aggregate Summary	
Screen Image		

Prints each type of screen.

**T**he sound output, filing data (recipe), CSV Data Transfer function, and logging functions are advanced features to use the GP with even higher performance. For the detailed information about these features, please refer to Tag Reference Manual. In addition, regarding the CF Card, the CF Card tool used on GP-PRO/PB III is described. For CF Card usage requirements as well as usage that is linked with other features, also refer to Tag Reference Manual.

<b>10.1</b>	<b>.....Sound Output</b>
<b>10.2</b>	<b>.....Filing Data (Recipe)</b>
<b>10.3</b>	<b>.....CSV Data Transfer Function</b>
<b>10.4</b>	<b>.....Logging</b>
<b>10.5</b>	<b>.....CF Card</b>
<b>10.6</b>	<b>..... Creating/Transferring CF Memory Loader Tool</b>
<b>10.7</b>	<b>..... CF Memory Loader Tool</b>

## 10.1 Sound Output

This feature outputs sound data from a speaker connected to the GP by turning ON a specified bit. Via Alarm or message sounds, information can be sent to operators even if they are not looking at the GP screen. In addition, this feature can be used for a variety of applications such as operation guides and multimedia information.

▼ **Reference** ▲ *Tag Reference Manual, 4.1 Sound Output*



**Sound settings are available only with the GP-477R, GP-577R and GP2000 series units (except the GP-2300, GP-2301, GP-2401 and GP2000H Series). Note that when using the GP-477R, GP-577R, GP-2501 and GP-2601 series units, an optional Multi Unit (sold separately) is required to output the sound data from the GP unit.**

## 10.2 Filing Data (Recipe)

Setting data that you have created and stored on the GP can be easily transferred to the PLC whenever necessary, using GP touch keys or by specifying bit addresses in the PLC. Also, Filing (Recipe)Data that has been transferred to the PLC can be then sent back to the GP, edited, and then transferred again to the PLC.

When using the GP77R series and GP2000 series, Filing Data stored in a CF Card can be transferred.

▼ **Reference** ▲ *Tag Reference Manual, 4.2 Filing Data (Recipe) Function*

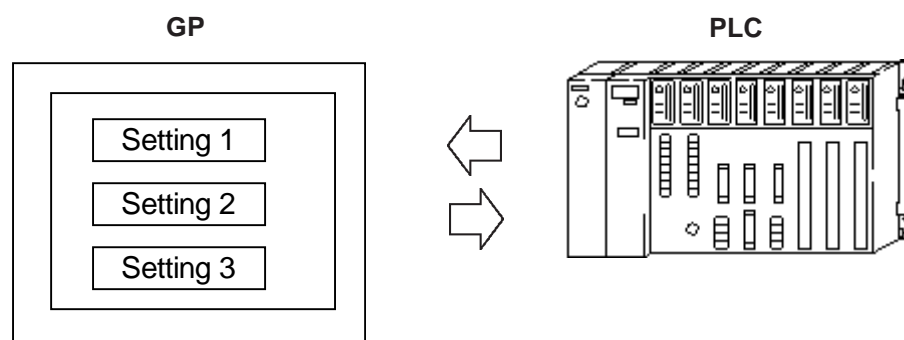

**The Filing Data feature has been supported only by the GP-377 Series, GP77R series and GP2000 series. Also, to transfer Filing Data from the CF Card by the GP77R series, the Multi Unit (sold separately) is required.**

## 10.3 CSV Data Transfer Function

Specific data-transfer CSV files (ZR\*\*\*\*\*.CSV) on the CF Card can be transferred from the CF Card directly to the PLC (filing) or from the PLC directly to the CF Card (logging). The data transfer method can be selected as either automatic transfer or manual transfer, and two or more CSV files can be transferred in one operation. The Data Transfer Display is used with manual transfer. The Data Transfer Display is useful for searching files because the file names of the data-transferring CSV files (ZR\*\*\*\*\*.CSV) can be displayed in a list.

The Data-Transferring CSV file on the CF Card can be created and edited with the CSV screen creation editor or general-purpose spreadsheet software such as Microsoft Excel.

**Reference** *2.1.18 Data Transfer Display and the Tag Reference Manual, 4.4 CSV Data Transfer Function/4.5 CSV Data Display Function*



**The CSV Data Transfer Function is available only with the GP2000 series.**

## 10.4 Logging

The device data is loaded to the GP's backup SRAM at bit-based or time-specified timings to display it in a tabular form on the screen or print it on the printer.

The acquired data can also be integrated into a database so that it can be analyzed.

Digital's GP77R series and GP2000 series units enable you to save logged data as a CSV file onto a CF Card. The CSV file can then be sent from the CF Card to any PC, and its information used for a database, or displayed as a graph for analysis.

**Reference** *Tag Reference Manual, 4.3 Logging Function*



- **Use of the CF Card with a GP77R series unit requires the Digital's optional Multi Unit (sold separately).**

## 10.5 CF Card

Digital's GP77R series and GP2000 series units all allow you to use the CF Card to store data.

The CF Card is intended primarily as an external storage device, for the storage of CSV files and backing up GP screen data.

For detailed CF Card information, refer to the Tag Reference Manual.

**Reference** *Tag Reference Manual, 4.7 Using the CF Card*

### 10.5.1 Using CF Card Tools

The use of the CF Card Tool enables you to copy data in your project's CF Card data output folder to the CF Card, as well as to copy data saved on the CF Card to the project. The data that can be copied using the CF Card Tool includes image screens, sound data, and Filing Data.



**To use the CF Card Tool your PC must be equipped with a PC card slot.**

#### Overview of the CF Card Tool

When you select the [Utility] menu - [CF Card Tool] option, the CF Card Tool is activated. The overview of the CF Card Tool is given below.

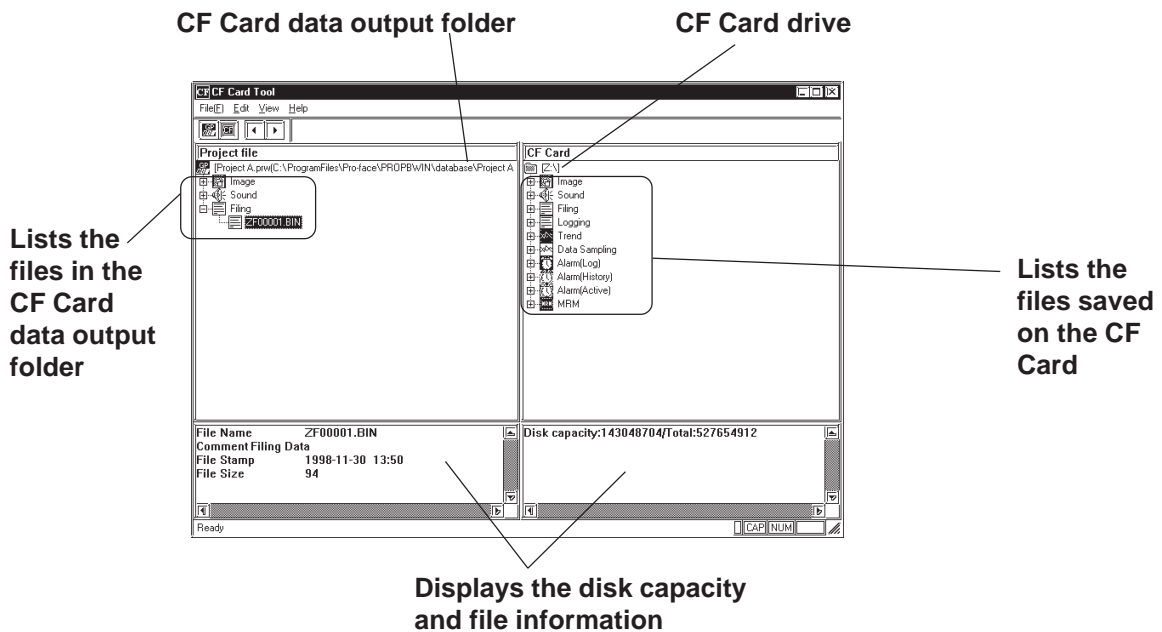



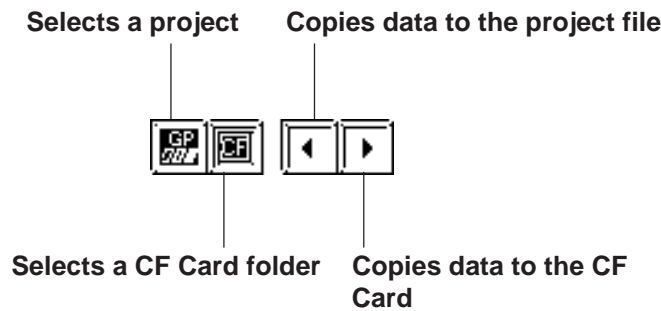

The toolbar icons have the following functions:



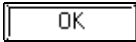
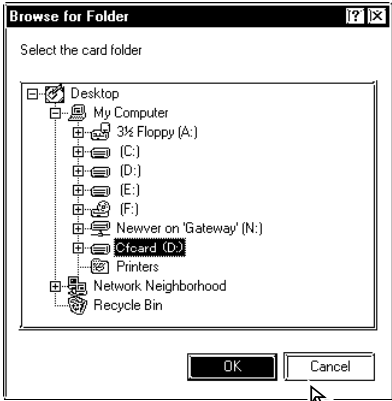
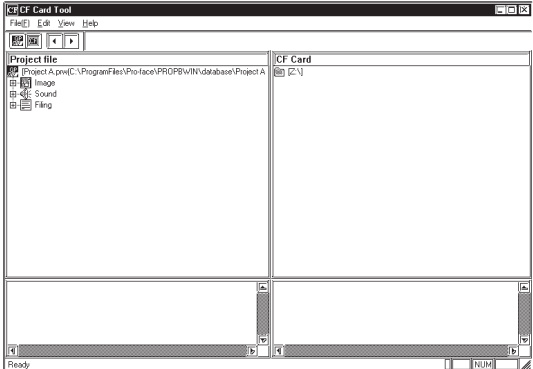

**■ Activating the CF Card Tool**

To use the CF Card, specify a drive for the CF Card on your PC.

PROCEDURE	REMARKS
<p>(1) Via the Project Manager, select the [Utility] menu - [CF Card Tool] command.</p> <p>(2) Specify a CF Card drive, and then click on the  button.</p> <p>The currently selected Project's information will be displayed in the left pane, and the CF Card's information in the right pane.</p>  <p style="text-align: center;">↓</p> <p>Information on the currently selected project is displayed in the pane on the left, while information on the CF Card is displayed in the pane on the right.</p> 	<p>If any CF Card drive is already specified, the Browse for Folder dialog box will not be opened.</p> <p>To change the CF Card drive, click on the  icon, or select the [File] menu - [Select CF Card Folder] command.</p> <p>The information of the currently selected project is displayed in the left pane, and that of the CF Card in the right window.</p>



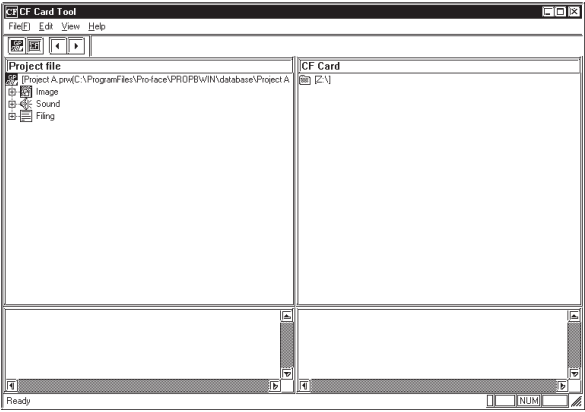

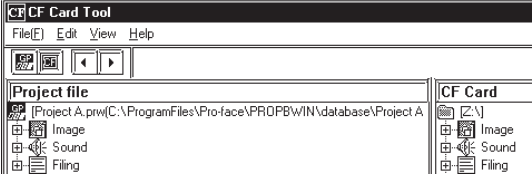
■ **Copying Data to the CF Card**

The data (image screens, sound data, and Filing Data) saved in the CF Card output folder can be copied from the project to the CF Card as follows.

PROCEDURE	REMARKS
<p><b>(1) Start the CF Card Tool.</b></p> 	<p>Select the CF Card data output folder in advance.</p> <p><b>Reference</b> ■ <i>Activating the CF Card Tool</i></p> <p>To change the CF Card drive, click on the  icon, or select the [File] menu - [Select CF Card Folder] option.</p>
<p><b>(2) Select the [Edit] menu - [Project to Card] command, or click on the  icon.</b></p> <p>The image screen, sound data, and Filing Data in the CF Card data output folder will be copied to the CF Card.</p> 	

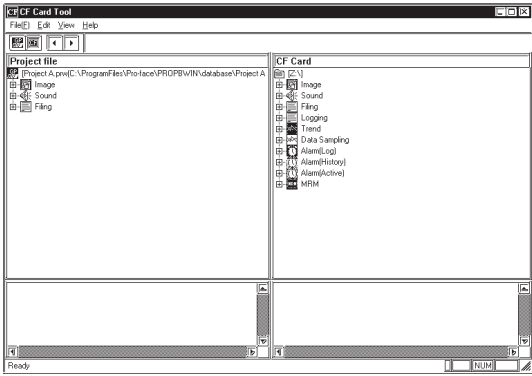
■ Copying Data to the Project

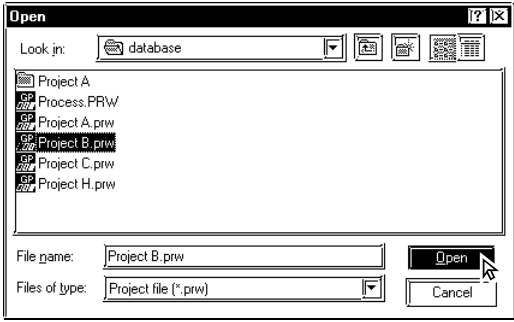
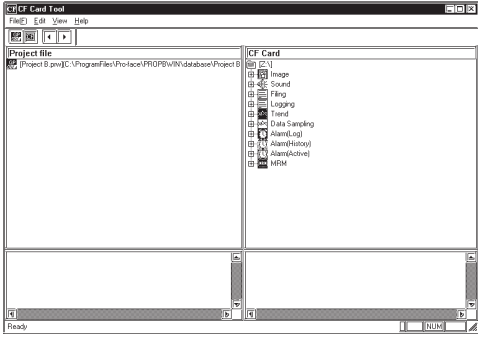
The data saved on the CF Card (image screens, sound data, and Filing Data) can be copied to the CF Card output folder for the project as follows.

PROCEDURE	REMARKS
<p>(1) Activate the CF Card Tool.</p>  <p>(2) Select the [File] menu - [Select Project] command, or click on the  icon.</p> <p>(3) Select the project file to which the data on the CF Card is to be copied, and then click on the  button.</p> <p>The selected Project's CF Card output folder will appear.</p>  <p style="text-align: center;">↓</p> 	<p> <b>Reference</b> ■ <i>Activating the CF Card Tool</i></p> <p>To change the CF Card drive, click on the  icon, or select the [File] menu - [Select CF Card Folder] option.</p>

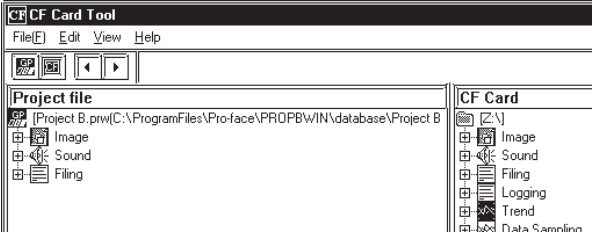
PROCEDURE	REMARKS
<p>(4) Select the [Edit] menu - [Card to Project] command, or click on the  icon.</p> <p>The image screen, sound data, Filing Data, Data-Transfer CSV file, startup system, backup data, dictionary file, and JPEG file saved to the CF Card will be copied to the CF Card data output folder for the specified project.</p> 	<p>The image screen, sound data, Filing Data, Data-Transferring CSV file, startup system, backup data, dictionary file, and JPEG file will be copied from the CF Card to the designated Project's folder. Other data (alarm data, trend graph data, sampled data, logged data, etc.) must be copied using Windows Explorer or other similar software.</p>

## 10.6 Creating/Transferring CF Memory Loader Tool



**Note:** The CF Memory Loader Tool function is only available with the GP2000 Series.

### 10.6.1 CF Memory Loader Tool / Backup Data

#### ■ GP-PRO/PBIII to CF Card, then to GP (via “CF Card Tool”)

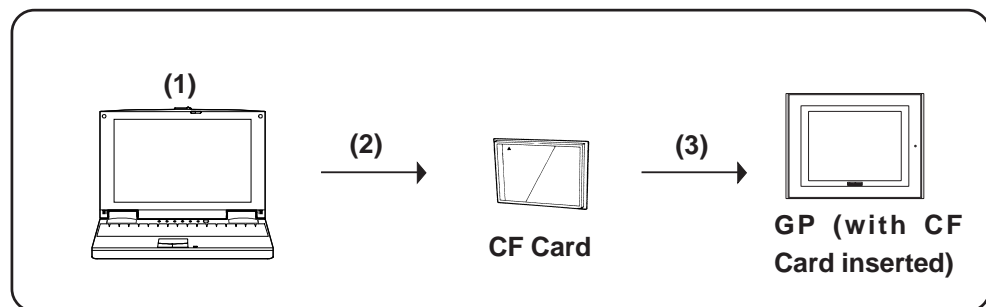

- (1) Creating backup data: Create GP backup data and “CF Memory Loader Tool” in the CF Card Data Output Folder.

▼ **Reference** ▲ *10.6.5 Creating Backup Data*

- (2) Copy data via “CF Card Tool”: Copy backup data in the CF Card Data Output folder and “CF Memory Loader Tool” to the CF Card, using GP-PRO/PBIII’s “CF Card Tool” feature.

▼ **Reference** ▲ *10.6.8 Transferring “CF Memory Loader Tool” data via CF Card Tool*

- (3) Download data using “CF Memory Loader Tool”: Transfer the CF Card’s backup data to the GP.

▼ **Reference** ▲ *10.7 CF Memory Loader Tool*







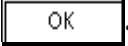
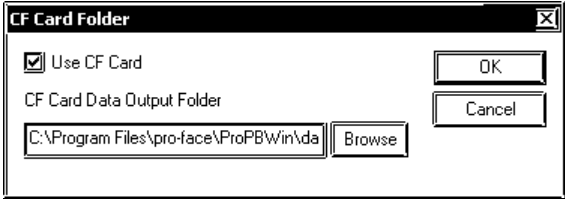

**Important**

**The total space required for using Filing Data and Image Data in addition to the CF Memory Loader Tool and Backup Data is at least 8 MB. The capacity of the CF Card may be insufficient. Please use the following CF cards produced by Digital Electronics Corporation when using the CF Memory Loader Tool.**

Name	Model Number
CF Card (64MB)	CA3-CFCALL/64MB-01
CF Card (128MB)	CA3-CFCALL/128MB-01
CF Card (256MB)	CA3-CFCALL/256MB-01
CF Card (512MB)	CA3-CFCALL/512MB-01

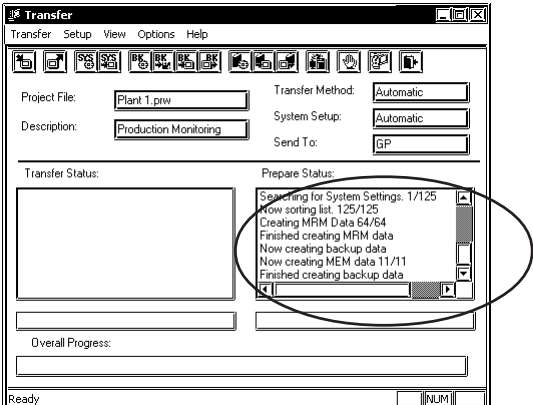
■ Send the data from PC to a CF card

PROCEDURE	REMARKS
<p>(1) Select [CF Card Output Folder] from the Project manager's [Project].</p> <p>(2) Click [Use CF Card], then select the CF Card Output Folder, and click .</p>  <p>(3) Create the backup data.</p> <p>Select [Transfer] from the Project manager's [Project] window, or click on . (You can also select [Transfer] from the Drawing Board screen's [Screen] menu or click on ).</p> <p>Select the [Transfer] menu's [Send system boot data to CF Card], or click on . Backup data will then be created in the CF Card Data Output folder .</p> <p>When the backup has been successfully completed, the following data transfer information is displayed.</p>  <p>In the CF Card Output Folder, CF Memory Loader Tool and the backup data has been created.</p>	<p>To create the CF Card Tool, you need to specify a location (CF Card data output folder).</p> <p>This folder temporarily saves the project data to save data to the CF Card.</p> <p>Use this feature to create "CF Memory Loader Tool" and the GP's backup data (BK****.MEM) that consists of system program data, screen data, expansion program data and communication protocol data.</p> <p> <b>Note:</b></p> <ul style="list-style-type: none"> <li>• The "****" code in the above file name "BK****.MEM" will vary according to the GP model.</li> <li>• The file names can be changed on the off-line screen of the GP.</li> </ul> <p><b>Reference</b> 10.7.4  <b>Menu Screen: 5. FILE LIST</b></p> <ul style="list-style-type: none"> <li>• If you wish to send only "CF Memory Loader Tool" data to the CF Card, you do not need to create GP backup data. Simply use the [Send system boot data to CF Card] feature.</li> <li>• When the GP-PRO/PB III is used, the backup data of only one project can be created on a single CF Card.</li> </ul>

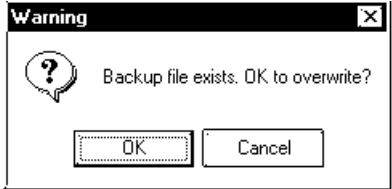
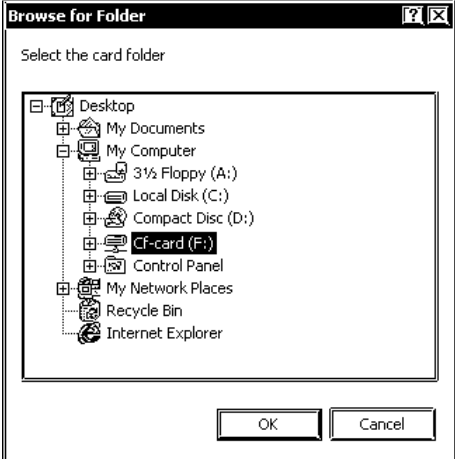
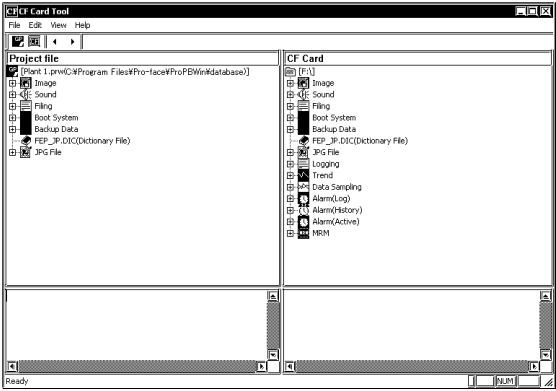
PROCEDURE	REMARKS
<p>(4) Use the CF Card Tool to copy backup data to the CF Card.</p> <p>Click on the Project Manager Utility menu's [CF Card Tool] selection to start the CF Card Tool.</p>	<p>If there is backup data previously saved in the CF Card data output folder, the following window will appear. If you wish to overwrite the existing data in the CF Card with the new backup data, select [OK]. If not, select [Cancel].</p> 
<p>(5) Select the drive containing the CF Card and click [OK].</p>	<p>For CF Card Tool information, <b>Reference</b> 10.5.1 Using CF Card Tools</p>
	
<p>In the following screen, Project information is shown on in the left-side pane, and CF Card information is shown in the right-side pane.</p>	
	

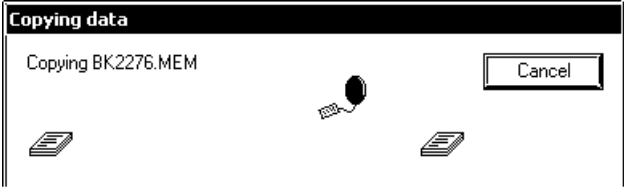
PROCEDURE	REMARKS
<p>(6) The project saved in the CF Card output folder is copied to the CF Card. Use the Edit menu's [Copy to CF Card] selection to start the copy, or click on the  icon.</p>  <p>(7) When the above dialog box disappears the copy is finished. The Memory Loader Tool and the Project Backup data creation is completed.</p>	<p>For information about downloading Project data to a GP from the CF Card, <a href="#">Reference 10.7 CF Memory Loader Tool</a></p>



### ■ GP-PRO/PBIII to GP, then to CF Card

You can use this method for data transmission when your PC is not equipped with a CF Card I/F.

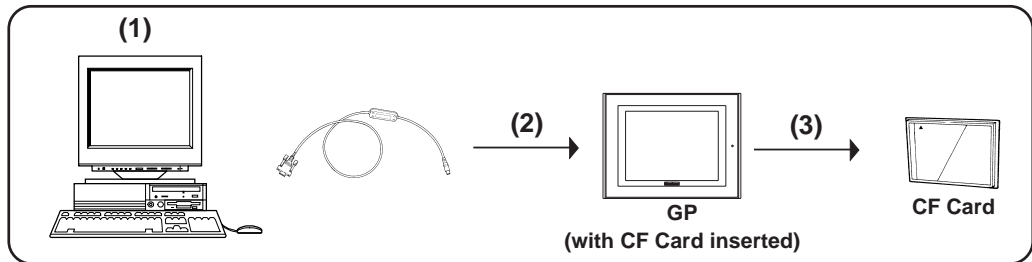

- (1) Create backup data: Create GP backup data and “CF Memory Loader Tool” in the CF Card Data Output Folder.

▼ **Reference** 10.6.5 Creating Backup Data

- (2) Send backup data: Send backup data and “CF Memory Loader Tool” in the CF Card Data Output folder to the GP where the CF Card is inserted (GP “A”).

▼ **Reference** 10.6.7 Sending Backup Data



**Note:** When using the GP data transfer cable (GPW-CB02), it will take approximately fifteen minutes to complete data transmission (when the baud rate is 115.2k bps).

### ■ GP to CF Card, then to GP

Data can be copied from a GP to another GP unit.

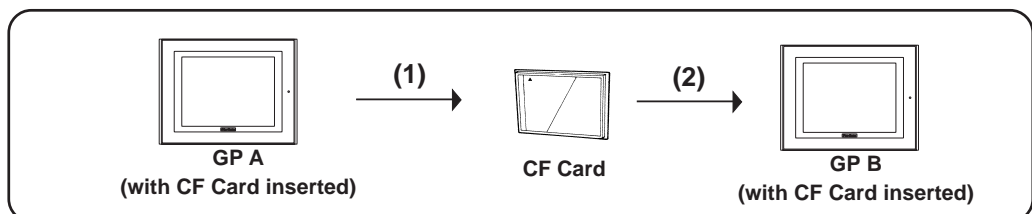

- (1) Upload data using the “CF Memory Loader Tool”.  
Transfer the backup data from the active GP unit to a CF Card.

▼ **Reference** 10.7 CF Memory Loader Tool

- (2) Download data using “CF Memory Loader Tool”.  
Download your backup data to the GP from the CF card.

▼ **Reference** 10.7 CF Memory Loader Tool



**You need to transfer “CF Memory Loader Tool” to the CF Card prior to starting the program via the CF Card.**

## 10.6.2 CF Memory Loader Settings

You need to call up the GP-PRO/PBIII [Transfer] screen to enter or use the CF Memory Loader's settings. To do this, select [Transfer] from the Project

Manager's (main screen's) [Project] window, or click on the  icon.

You can also select [Transfer] from the Drawing Area screen's [Screen] menu, or simply click on the  icon. The following explanation describes the [Transfer] screen's CF Memory Loader settings.

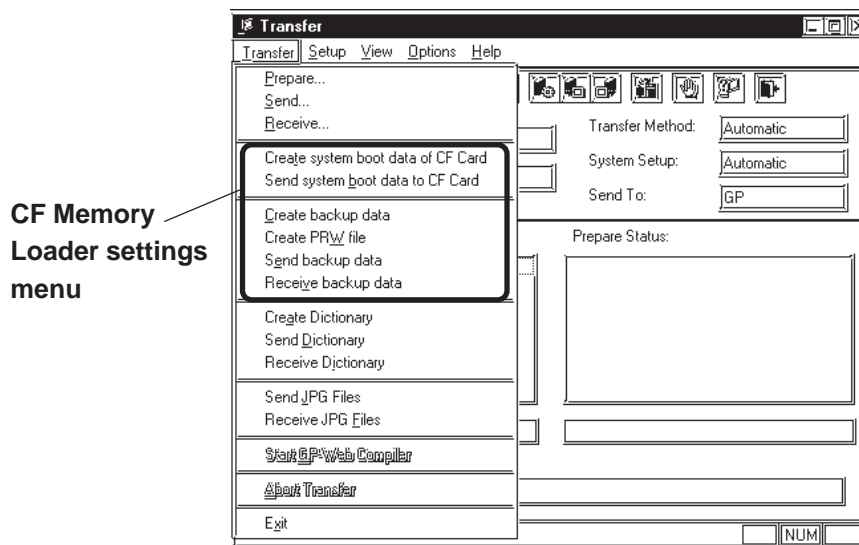

### ■ Create system boot data of CF Card

This feature allows you to create a copy of the "CF Memory Loader Tool" in the CF Card Data Output folder. Backup data creation, however, is NOT possible with this feature.

### ■ Send system boot data to CF Card

This feature allows you to download the "CF Memory Loader Tool" to your GP's CF Card from your GP's CF Card Data Output folder. Backup data creation, however, is NOT possible with this feature.

### ■ Create backup data

This feature allows you to create a copy of your GP backup data, as well as the "CF Memory Loader Tool", in the CF Card Data Output folder.

### ■ Create PRW file

With this function, you can convert the GP's backup data (BK\*\*\*\*.MEM) into a project file (.prw).

### ■ Send backup data

This feature allows you to download the CF Card Data Output folder's GP backup data and "CF Memory Loader Tool" to your CF Card.

■ **Receive backup data**

Transfers the backup data saved in your GP’s CF Card to your PC’s GP-PRO/PBIII software. However, the “CF Memory Loader Tool” itself cannot be transferred.

You can also select these features via the GP-PRO/PBIII Transfer Screen’s toolbar icons.

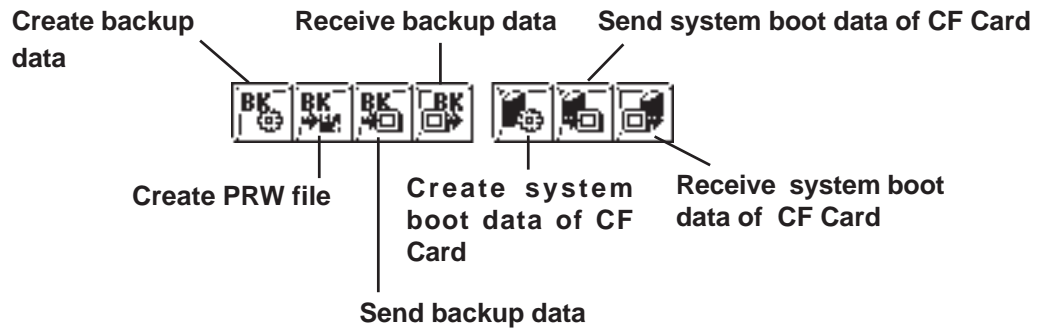

**10.6.3 Creating System Boot Data for CF Card**

To use the “CF Memory Loader Tool”, you need to first create (prepare) the “CF Memory Loader Tool “ (IPL.SYS, MLD\*\*\*\*.SYS, GPBACKUP.INF) in GP-PRO/PBIII via the “Create system boot data of CF Card” feature, and download it to your GP’s CF Card. Then, upload the “CF Memory Loader Tool“ program data from the CF Card to the GP. The GP can then use the “CF Memory Loader Tool” saved on the CF Card. The following steps explain how to create the “CF Memory Loader Tool” in GP-PRO/PBIII.





**Note:** The “\*\*\*\*” code in the above file name “MLD\*\*\*\*.SYS” will vary according to the GP model.

GP Type	GP Code	GP Type	GP Code
GP2301HL	2240	GP2300T	2256
GP2301HS	2242	GP2400T	2261
GP2401H	2244	GP2401T	2262
GP2300L	2252	GP2500T	2266
GP2301L	2250	GP2501T	2267
GP2500L	226F	GP2600T	2276
GP2501L	226A	GP2601T	2277
GP2300S	2253	GLC2300L	225A
GP2301S	2251	GLC2300T	225E
GP2301T	2254	GLC2400T	2269
GP2500S	226D	GLC2500T	226E
GP2501S	2268	GLC2600T	227E

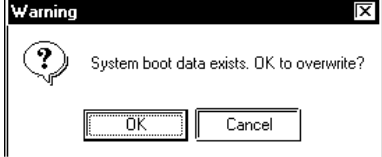

The names of files on the CF Card cannot be changed with the GP-PRO/PB III. These files must first be downloaded to the GP, where their names can be changed on the GP's off-line screen.

**Reference** 10.7.4 Menu Screen: 5. FILE LIST

PROCEDURE	REMARKS
<p>(1) Select [Transfer] from the Project Manager’s [Project] window, or click on  . (You can also select [Transfer] from the Drawing Board screen’s [Screen] menu or click on  ).</p> <p>(2) Select the [Transfer] menu’s [Create system boot data of CF Card], or click on  . The “CF Memory Loader Tool” will then be created in the CF Card Data Output folder.</p>	<p>If the “CF Memory Loader Tool” is previously saved in the CF Card data output folder, the following window will appear. If you wish to overwrite it with new data, click on the [OK] button.</p> 

### 10.6.4 Sending System Boot Data to CF Card

This feature is used when transferring the “CF Memory Loader Tool” to the CF Card.

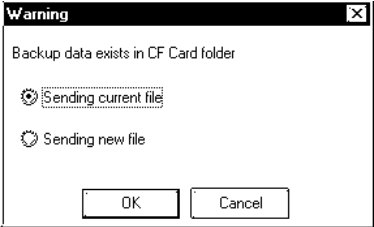
PROCEDURE	REMARKS
<p>(1) Select [Transfer] from the Project manager’s [Project] window, or click on . (You can also select [Transfer] from the Drawing Board screen’s [Screen] menu or click on ).</p> <p>(2) Select the [Transfer] menu’s [Send system boot data to CF Card], or click on . The “CF Memory Loader Tool” in the CF Card Data Output folder is then downloaded to the CF Card.</p>	<p>If there is a “CF Memory Loader Tool” previously saved in the CF Card data output folder, the following window will appear. If you wish to send the old (existing) “CF Memory Loader Tool” in the CF Card to the CF Card, select [Sending current file], if you wish to send the new data, select [Sending new file].</p> 

**10.6.5 Creating Backup Data**



Use this feature to create “CF Memory Loader Tool” and the GP’s backup data (BK\*\*\*\*.MEM) that consists of system program data, screen data, expansion program data and communication protocol data.



- The “\*\*\*\*” code in the above file name ” BK\*\*\*\*.MEM” will vary according to the GP model.
- The file names can be changed on the off-line screen of the GP.

**Reference** 10.7.4 Menu Screen: 5. FILE LIST

- If you wish to send only "CF Memory Loader Tool" data to the CF Card, you do not need to create GP backup data. Simply use the [Send system boot data to CF Card] feature.
- When the GP-PRO/PB III is used, the backup data of only one project can be created on a single CF Card.

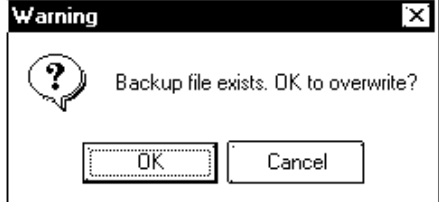



PROCEDURE	REMARKS
<p>(1) Select [Transfer] from the Project manager’s [Project] window, or click on . (You can also select [Transfer] from the Drawing Board screen’s [Screen] menu or click on ).</p> <p>(2) Select the [Transfer] menu’s [Send system boot data to CF Card], or click on . Backup data will then be created in the CF Card Data Output folder .</p>	<p>If there is backup data previously saved in the CF Card data output folder, the following window will appear. If you wish to overwrite the existing data in the CF Card with the new backup data, select [OK]. If not, select [Cancel].</p> 



**10.6.6 Creating a PRW file**

A project file (.prw) can be created by converting the backup data on the GP (.MEM).

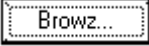
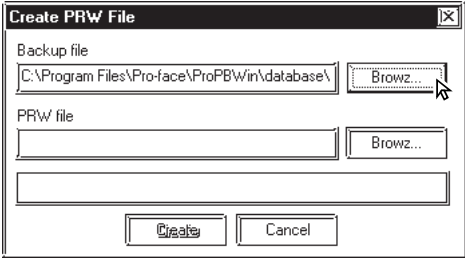

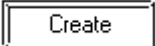
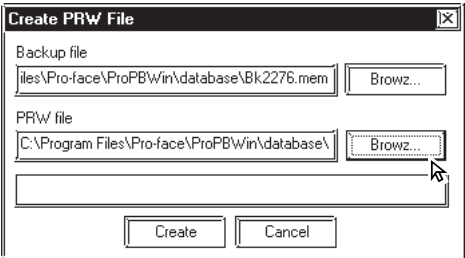
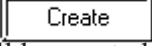
- **Only MEM files having file names like BK\*\*\*\*.MEM (\*\*\*\* designates the GP model) can be specified as files to be converted. Also when the file name is changed (renamed) through the CF Memory Loader Tool, only those files whose names are changed according to the above format can be specified as files to be converted.**
- **When using GLC2000 Series, be sure to select [Back up logic program] at the time of creating a backup file, if it's not selected. When the backup file is converted into a project file, the logic program cannot be converted together with it.**

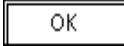
PROCEDURE	REMARKS
<p>(1) Select [Transfer] from the Project manager's [Project] window, or click on . (You can also select [Transfer] from the Drawing Board screen's [Screen] menu or click on ).</p> <p>(2) Select [Create PRW File] on the [Transfer] menu or click on .</p> <p>(3) Click on the  button and select the backup file (.MEM) to be converted.</p>  <p>(4) Click on the  button, select the project file (.prw) to create, and click on the  button.</p> 	<p>Before creating the backup file data, first transfer the prw file containing the "upload information" to the GP. If you specify a backup file (.MEM) created without the "upload information" and click on the  button, no prw file will be created. The following dialog box appears instead.</p>

PROCEDURE	REMARKS
<p>(5) Once the project file (.prw) has been properly created, click on the  button to close the box.</p> 	



### 10.6.7 Sending Backup Data

This feature allows you to send GP backup data created in the GP-PRO/PBIII to the CF Card. There are two methods, you can use:

**Method 1:** Transfer backup data from GP-PRO/PBIII directly to your PC's CF Card.

**Method 2:** Transfer backup data from GP-PRO/PBIII to a GP, then from the GP to that GP's CF Card.

The following section explains Method 2.

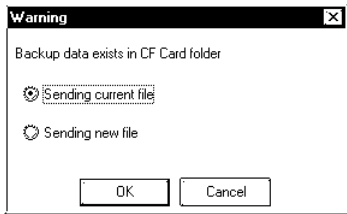
PROCEDURE	REMARKS
<p>(1) Select [Transfer] from the Project manager's [Project] window, or click on . (You can also select [Transfer] from the Drawing Board screen's [Screen] menu or click on ).</p> <p>(2) Select the [Transfer] menu's [Send backup data to CF Card], or click on . The backup data will then be transferred from your PC to the CF Card Data Output folder.</p>	<p>If the connected GP unit is not a GP2000 Series unit, the backup data transfer error message will appear and the backup data cannot be transferred. If there is backup data previously saved in the CF Card data output folder, the following window will appear. If you wish to overwrite the existing backup data in the CF Card with the current project's backup data, select [OK].</p> 



### 10.6.8 Receiving Backup Data

Here the CF Card's backup data "BK\*\*\*\*.MEM" is transferred from the GP to GP-PRO/PBIII in your PC. The received backup data cannot be directly opened as a Project file. Transfer the backup data to the GP unit and load the data from the GP unit. The received data are converted to a Project file (\*.prw).



**Note:** The "\*\*\*\*" code in the above file name "BK\*\*\*\*.MEM" will vary according to the GP model.

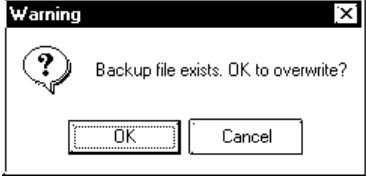

PROCEDURE	REMARKS
<p>(1) Select [Transfer] from the Project manager's [Project] window, or click on . (You can also select [Transfer] from the Drawing Board screen's [Screen] menu or click on ).</p> <p>(2) Select [Transfer]'s [Send system boot data to CF Card], or click on .</p>	<p>If there is backup data previously saved in the CF Card data output folder, the following window will appear. If you wish to overwrite the existing data in the CF Card with the new backup data, select [OK]. If not, select [Cancel].</p> 

### 10.6.9 Transferring "CF Memory Loader Tool" data via CF Card Tool

This feature allows you to confirm the type of backup data present, or copy data from GP-PRO/PBIII to the CF Card, and also from the CF Card to the GP-PRO/PBIII.

**Reference** [10.5.1 Using CF Card Tools](#)

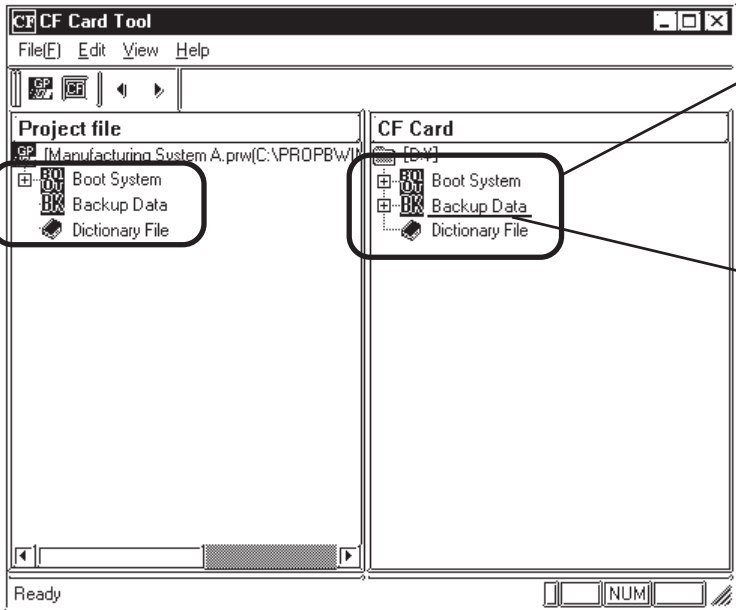

**You can view the list of files saved in the CF Card data output folder here.**

**You can view the list of files saved in the CF Card here.**

**Here, the title of the project file created in the CF Card is shown. However, when the project file's backup data is created via the CF Memory Loader Tool, the title may not be shown here.**



- **If there is no "CF Memory Loader Tool" data, the CF Card cannot be used as a system boot disk, and the boot system data will not appear in the CF Card Tool window. Also, if there is no backup data, it will not appear in the CF Card Tool window.**
- **In order to use the CF Card Tool, your PC must be equipped with a CF Card Slot.**



**Note:** If your PC is equipped with a CF Card Slot, using the CF Card Tool to transfer data to/from the CF Card is recommended since this transfer method takes less time than when using the GP.

## 10.7 CF Memory Loader Tool

### 10.7.1 About "CF Memory Loader Tool"

The "CF Memory Loader Tool" has the following features.

#### ■ **UPLOAD**

This feature allows you to transfer all the GP's data to the CF Card.

#### ■ **DOWNLOAD**

This feature allows you to transfer the CF Card's backup data to the GP.

#### ■ **SYSTEM DATA DISPLAY**

View both the CF Card's backup data and the GP's data.

#### ■ **COMPARISON**

Compare all GP data to the CF Card's uploaded backup data.

#### ■ **FILE LIST**

Lists the files stored on the CF Card. This feature also allows you to view the details of the selected file or to copy, delete or rename the files on the CF Card.



**Note:** This feature is only available with the GP2000 Series.

## 10.7.2 Starting the "CF Memory Loader Tool"

There are two methods for starting this program via the CF Card.

### 1. Menu Bar: Using the GP's [CF BOOT] menu

To call up the GP's menu screen, press point (1), and (2) with your right hand fingers. While holding these points, press point (3) with your left hand finger. After the menu appears, touch the menu screen's [CF BOOT] selection and the GP will be reset. After it restarts, the CF card's "CF Memory Loader Tool" screen will appear.



**You need to transfer "CF Memory Loader Tool" to the CF Card prior to starting the program via the CF Card.**

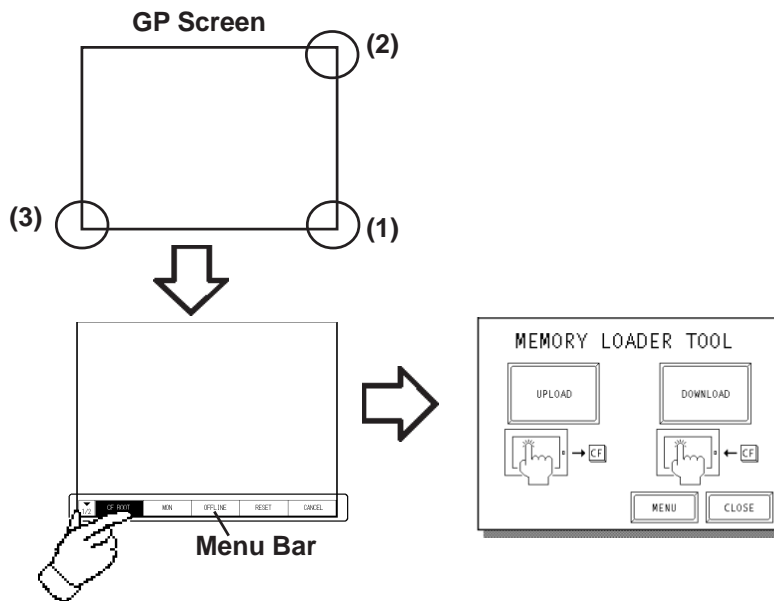

### 2. GP Dip Switches: Forced Start via GP Dip Switches

You can also use the Dip Switches on the rear of the GP, next to the CF Card Slot. If you turn ON Dip Switch No.1 (raise it) and then connect the GP's power cord, the "CF Memory Loader Tool" will start.



**To use the "CF Memory Loader Tool", it must be previously saved to the CF Card. Therefore, be sure to create the "CF Memory Loader Tool" on your PC with the GP-PRO/PBIII and transfer it to your GP's CF Card prior to using this program.**

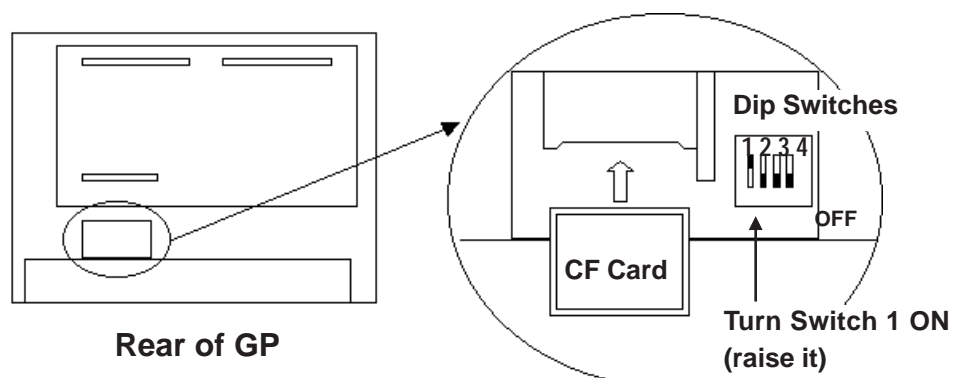

### 10.7.3 MEMORY LOADER TOOL

When the Memory Loader Tool program is started, the following screen will appear.

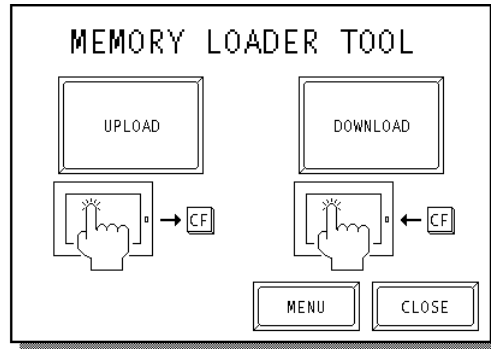

#### ■ UPLOAD (From GP to CF Card)

This feature is for saving all GP data (i.e. system program, communication protocol, expansion program, screen data and Backup SRAM data) in the CF Card.



**When *UPLOAD* is performed, the CF Card's current Backup Data will be completely overwritten.**

#### ■ DOWNLOAD (From CF Card to GP)

This feature is for writing CF Card backup data to the GP's Internal Memory.



**When *DOWNLOAD* is performed, the GP's Internal Memory data (i.e. system program, communication protocol, expansion program, screen data and Backup SRAM data) will be completely overwritten.**

#### ■ MENU

Touching this button changes to the Menu screen.

#### ■ CLOSE

Touching this button finishes the program and resets the GP.



**If you touch the *CLOSE* button and the GP's rear face #1 Dip Switch is turned ON, the "CF Memory Loader Tool" will automatically start again when the GP starts up. Therefore, to finish the CF Memory Loader operation, you need to first turn #1 Dip Switch OFF or remove the CF Card from the GP, then touch the *CLOSE* button.**

**10.7.4 Menu Screen**

If you touch the [MENU] button, the following screen appears.

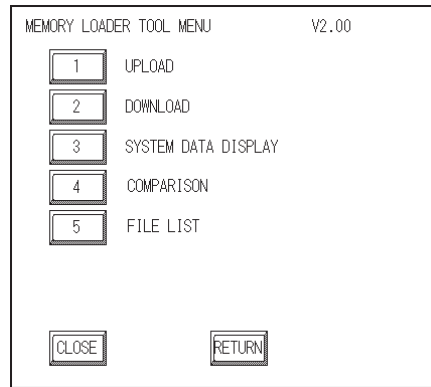

**1. UPLOAD (from GP to CF Card)**

PROCEDURE	REMARKS
<p><b>(1) Touch [1 UPLOAD] on the MEMORY LOADER TOOL MENU screen and the following screen will appear.</b></p> <p><b>[To change the backup file to be uploaded]</b></p> <p><b>(2) Touch [FILE] to call up the file selection screen. Select the backup file to be uploaded and touch [ENTER].</b></p> <p>To cancel the file selection, touch [RETURN] to return to the UPLOAD screen.</p> <p><b>Touch this button to display the system information of the selected backup file.</b></p>	<p>Enter the password you have registered in GP-PRO/PBIII' s [Transfer] screen. If you have not registered a password, simply touch [START], and data upload will start.</p> <p>The displayed path name is limited to 30 characters. The 31st and subsequent characters are omitted.</p> <p>A maximum of 50 file names can be displayed.</p> <p>Touching the column heading (FILE NAME/DATE) sorts the displayed file names in ascending order according to the heading selected.</p>

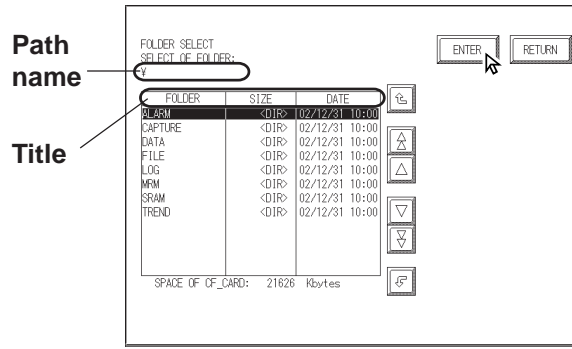
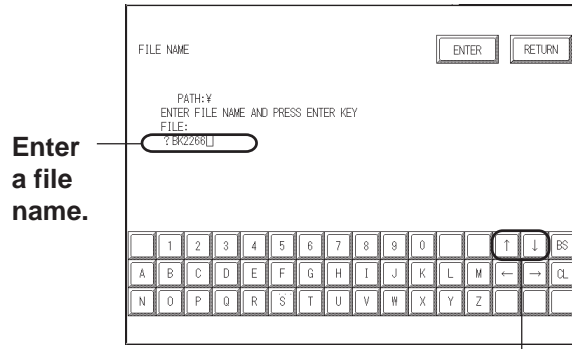
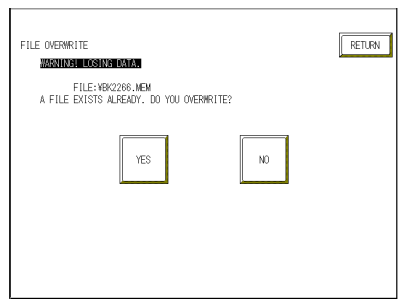
PROCEDURE	REMARKS
<p><b>[To change the folder to be uploaded]</b></p> <p>(2) Touch <b>FOLDER</b> to call up the folder selection screen.</p> <p>Select the folder to be uploaded and touch <b>ENTER</b>.</p> <p>To cancel the folder selection, touch <b>RETURN</b> to return to the UPLOAD screen.</p>  <p><b>Path name</b></p> <p><b>Title</b></p>	<p>The displayed path name is limited to 30 characters. The 31st and subsequent characters are omitted.</p> <p>A maximum of 50 file names can be displayed.</p> <p>Touching the column heading (FOLDER NAME/DATE) sorts the displayed file names in ascending order according to the heading selected.</p>
<p><b>[When a new file is created for the upload operation]</b></p> <p>(2) Touch <b>NEW FILE</b> to call up the file name input screen.</p> <p>Enter a file name and touch <b>ENTER</b>.</p> <p>To cancel the file creation, touch <b>RETURN</b>.</p>  <p><b>Enter a file name.</b></p> <p><b>Changes the input mode.</b></p>	<p>The displayed path name is limited to 30 characters. The 31st and subsequent characters are omitted.</p> <p>The file name is limited to eight single-byte alphanumeric characters. The file extension cannot be modified.</p> <p>The input mode can be changed in the following order: single-byte alphanumeric (uppercase) → single-byte alphanumeric (lowercase) → numbers and symbols.</p>
<p>(3) Return to the UPLOAD screen and enter your password on the screen's keypad.</p> <p>(4) Touch <b>[START]</b> and data upload will start.</p>	<p>If the entered file name already exists in the CF Card, the following message will appear to confirm the overwrite operation.</p> 

## ■ UPLOAD Status

Once upload starts, the UPLOAD status screen will appear.

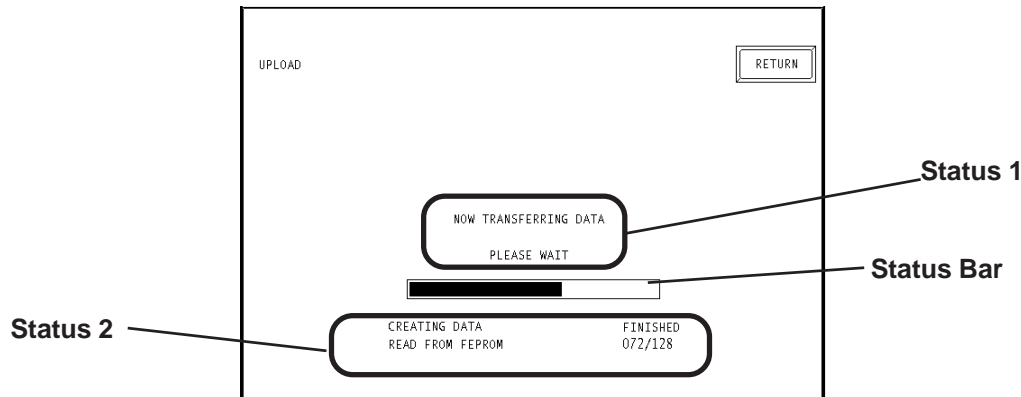

### ◆ Status 1

The message “NOW TRANSFERRING DATA PLEASE WAIT” will appear. If an error is detected during upload, an error message will appear.

### ◆ Status 2

UPLOAD Status information consists of the following data.

- Creating data (GP internal data)
- Read from FEPR0M data (i.e. system program, communication protocol, expansion program, screen data and Backup SRAM data)
- Read from Backup SRAM data



**Note:** Each “block” in the UPLOAD Status Bar represents 64K bytes of data.

### ◆ Status Bar

The Status Bar shows the progress of the upload.

### ◆ RETURN

If you perform UPLOAD from the INITIALIZE screen, touching this button returns you to the INITIALIZE screen. If you perform UPLOAD from the MENU screen, the screen will return to the MENU screen.



**WARNING**

- **Be sure to check if the GP’s CF Card Access LED is turned OFF prior to inserting/removing the CF Card since there is a danger of loss of CF Card data**
- **While a CF Card is being accessed, DO NOT disconnect the GP power cord or reset the GP, or insert/remove the CF Card.**



**Important**

**Performing UPLOAD completely overwrites the CF Card’s current Backup data.**

2. DOWNLOAD (from CF Card to GP)

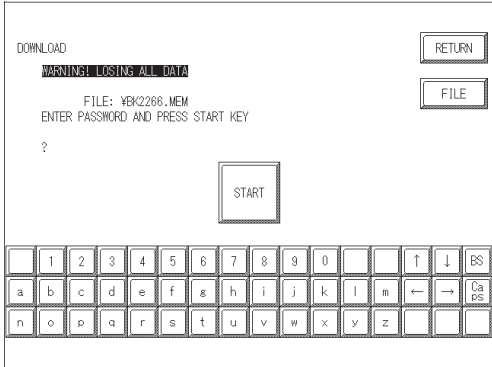
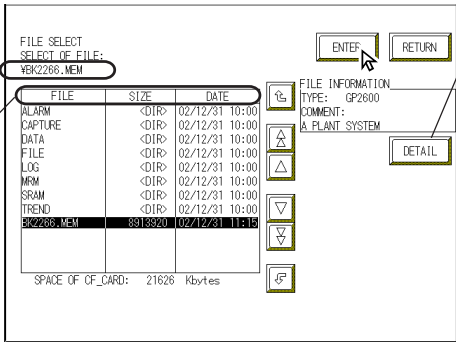
PROCEDURE	REMARKS
<p>(1) Touch [2 DOWNLOAD] on the MEMORY LOADER TOOL MENU screen and the following screen will appear.</p>  <p>[To change the backup file to be downloaded]</p> <p>(2) Touch <b>FILE</b> to call up the file selection screen. Select the backup file to be downloaded and touch <b>ENTER</b>. To cancel the file selection, touch <b>RETURN</b> to return to the DOWNLOAD screen</p>  <p>(3) Enter your password using the screen's keypad.</p> <p>(4) Touch [START] and data download will begin.</p>	<p>Enter the password you have registered in the GP-PRO/PBIII's [Transfer] screen. If you have not registered a password, simply touch [START] and data download will start.</p> <p>The displayed path name is limited to 30 characters. The 31st and subsequent characters are omitted.</p> <p>A maximum of 50 file names can be displayed.</p> <p>Touching the column heading (FILE NAME/DATE) sorts the displayed file names in ascending order according to the heading selected.</p>



## ■ DOWNLOAD Status

Once download starts, the DOWNLOAD status screen will appear.

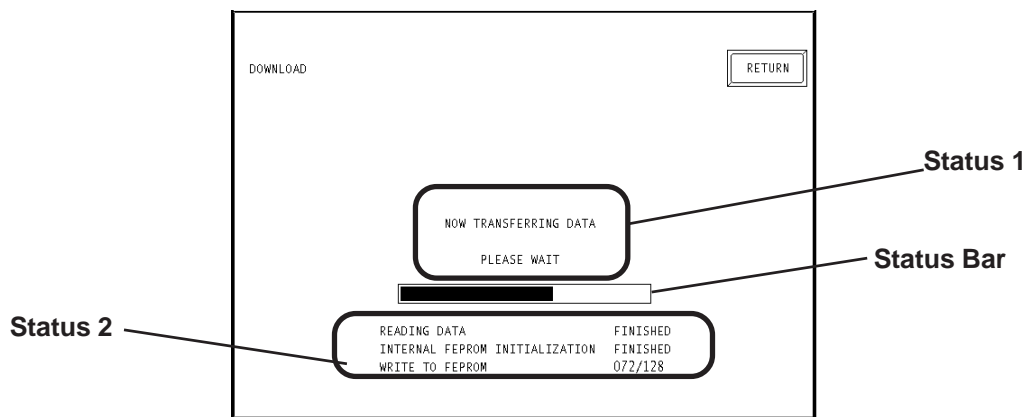

### ◆ Status 1

The message “NOW TRANSFERRING DATA PLEASE WAIT” will appear. If an error is detected during download, an error message will appear.

### ◆ Status 2

DOWNLOAD Status information consists of the following data.

- Reading data (GP internal data)
- Initialize Internal FEPRM data
- Write to Internal FEPRM data
- Write to Backup SRAM data



**Note:** Each “block” in the DOWNLOAD Status Bar represents 64K bytes of data.

### ◆ Status Bar

The Status Bar shows the progress of download.

### ◆ RETURN

If you perform DOWNLOAD from the INITIALIZE screen, touching this button returns you to the INITIALIZE screen. If you perform DOWNLOAD from the MENU screen, the screen will return to the MENU screen.



- **Be sure to check if the GP’s CF Card Access LED is turned OFF prior to inserting/removing the CF Card since there is a danger of loss of CF Card data.**

- **While a CF Card is being accessed, DO NOT disconnect the GP power cord or reset the GP, or insert/remove the CF Card.**



**Performing DOWNLOAD completely overwrites all data (the System, Communication Protocol, Extended Programs, Screen Data and Backup SRAM Data).**

### 3. SYSTEM DATA DISPLAY

If you touch [3 SYSTEM DATA DISPLAY], the following screen will appear. Here, you can see details of both the CF Card's uploaded data and the GP's internal data. To view the data uploaded from the CF Card, touch the [[CF INFO]] button.

#### ■ SYSTEM DATA DISPLAY (INTERNAL DATA)

If you touch the [INTERNAL] button, the following screen will appear. You can check GP Internal data with this screen.

SYSTEM DATA DISPLAY (INTERNAL DATA)

[SYSTEM DATA]  
 UNIT TYPE : GP2600  
 SYSTEM VERSION : V4.00  
 COMMUNICATION PROTOCOL : MELSEC-ANA V1.41  
 ETHERNET PROTOCOL : V4.15  
 SIMULATION : V3.34  
 EXPANSION SIO : EXT-SIO-SCR V2.00

[SCREEN DATA]  
 SCREEN EDITOR VERSION : V7.00  
 PROJECT COMMENT : A PLANT SYSTEM

[UPLOAD DATA SIZE]  
 INTERNAL FEPROM SIZE : 8192 Kbytes  
 SRAM SIZE : 0512 Kbytes

Buttons: NEXT, CF CARD, RETURN

Displays GP internal data information

Displays the control information of the GLC's internal data when the selected GP type is a GLC.

**Reference** *Pro-Control Editor Operation Manual*

#### ◆ SYSTEM DATA

<Display Example>

UNIT TYPE : GP2600  
 SYSTEM VERSION : V4.00  
 COMMUNICATION PROTOCOL :MELSEC-ANA V1.41  
 ETHERNET PROTOCOL :V4.15  
 SIMULATION :V3.34  
 EXPANSION SIO :EXT-SIO-SCR V2.00



**Note:** The “SIMULATION” data will change to “LADDER MONITOR” when there is a ladder monitor program.

#### ◆ SCREEN DATA

<Display Example>

SCREEN EDITOR VERSION :V7.00  
 PROJECT COMMENT :A PLANT SYSTEM (Up to 60 characters can be used)



**Note:** If Upload Information Data is not transferred when transferring Screen Data, an error message informs you that there is no Upload Information Data, and the Screen Data will not be displayed.

#### ◆ UPLOAD DATA SIZE

<Display Example>

INTERNAL FEPROM SIZE :8192K bytes  
 SRAM SIZE :512K bytes

■ SYSTEM DATA DISPLAY (CF CARD'S DATA)

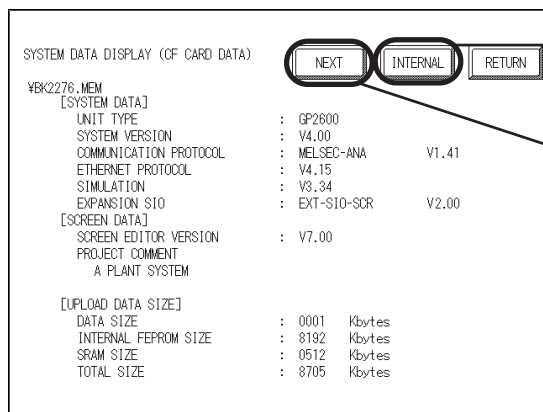

Displays the CF Card's uploaded data details.

Displays the control information of the GLC's internal data when the selected GP type is a GLC.

**Reference** Pro-Control Editor Operation Manual

The following are System Data Display examples.

This screen allows you to check the details of the selected backup file (.MEM) stored on the CF Card and the uploaded data.

◆ SYSTEM DATA <Display Example>

UNIT TYPE	:GP2600
SYSTEM VERSION	:V4.00
COMMUNICATION PROTOCOL	:MELSEC-ANA V1.41
ETHERNET PROTOCOL	:V4.15
SIMULATION	:V3.34
EXPANSION SIO	:EXT-SIO-SCR V2.00

- The “SIMULATION” data will change to “LADDER MONITOR” when there is a ladder monitor program.
- If there is no system program in the CF Card’s uploaded data, the “SYSTEM VERSION” will be “NONE”.



◆ SCREEN DATA <Display Example>

SCREEN EDITOR VERSION	:V7.00
PROJECT COMMENT	:A PLANT SYSTEM (Up to 60 characters can be used)

If there is no Upload Information Data in the GP, an error message will appear informing you that there is no Upload Information Data, and the Screen Data will not be displayed.





◆ UPLOAD DATA SIZE <Display Example>

DATA SIZE	:1K byte
INTERNAL_FEPROM SIZE	:8192K bytes
SRAM SIZE	:512K bytes
TOTAL SIZE	:8705K bytes

### 4. COMPARISON

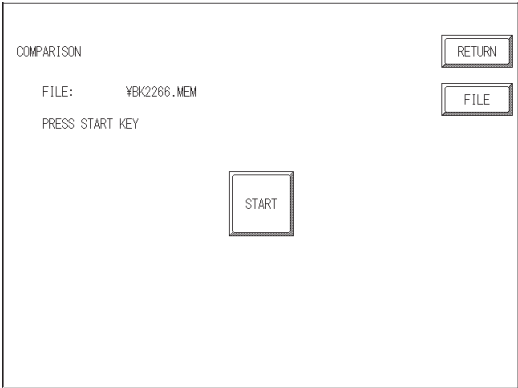
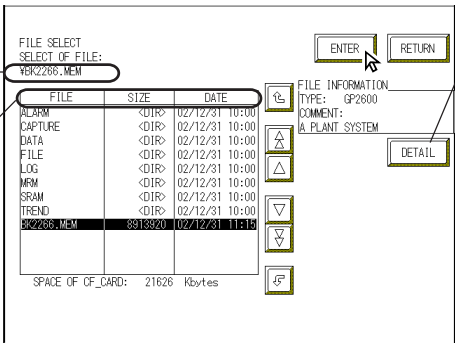
If you select [4. COMPARISON], the following screen will appear. This screen allows you to compare all the GP's data (i.e. system program, communication protocol, expansion program, screen data and Backup SRAM data) with backup data that is uploaded in the CF Card.

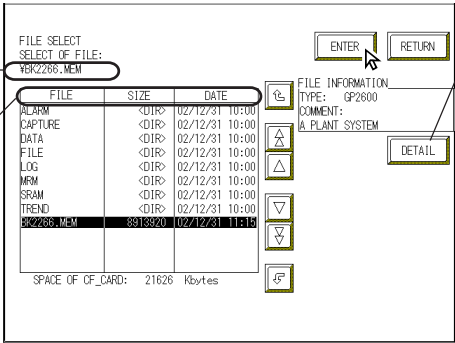
PROCEDURE	REMARKS
<p>(1) Touch [COMPARISON] on the MEMORY LOADER TOOL MENU screen and the following screen will appear.</p>  <p>[To change the backup file to be compared with the GP data]</p> <p>(2) Touch  to call up the file selection screen. Select the backup file to be compared with the GP data and touch . To cancel the file selection, touch  to return to the COMPARISON screen.</p>  <p>(3) The [COMPARISON] screen appears and all GP data is compared with backup data uploaded from the CF Card.</p>	<p>The displayed path name is limited to 30 characters. The 31st and subsequent characters are omitted.</p> <p>A maximum of 50 file names can be displayed.</p> <p>Touching the column heading (FILE/SIZE/DATE) sorts the displayed file names in ascending order according to the heading selected.</p>

■ **COMPARISON Status**

Once [COMPARISON] begins, the progress of the comparison can be seen on the following screen.

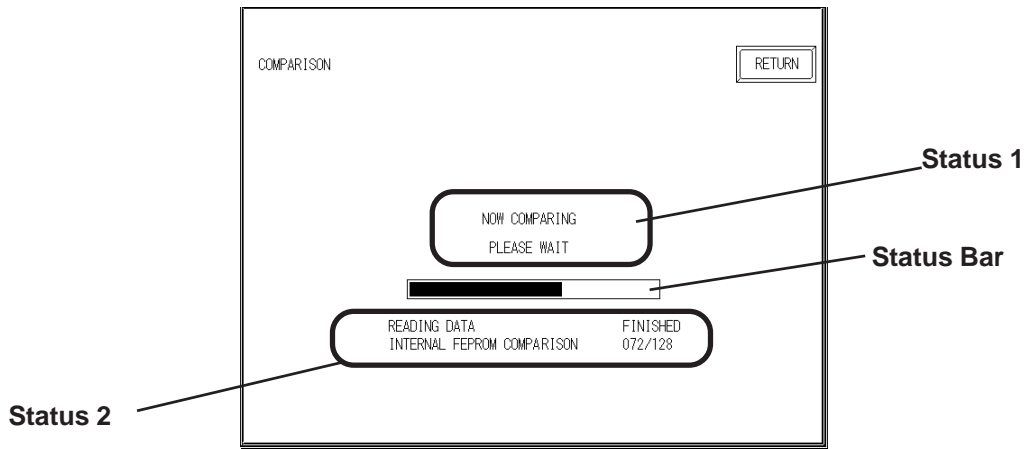

◆ **Status 1**

The message “NOW COMPARING PLEASE WAIT” will appear. If an error is detected during the [COMPARISON], an error message will appear.

◆ **Status 2**

COMPARISON Status information consists of the following data.

- Reading data (GP internal data)
- Comparing with Internal FEPRM data
- Comparing with Backup SRAM data



**Note:** Each “block” in the COMPARISON Status Bar represents 64K bytes of data.

◆ **Status Bar**

This bar shows the progress of the [COMPARISON].

◆ **RETURN**

Touching this button returns you to the MENU screen.

### 5. FILE LIST

Touch the [5 FILE LIST] button to display the following screen.

This feature allows you to list the files stored on the CF Card, to view the details of the selected file, or to copy, delete or rename the files on the CF Card.

#### ■ FILE LIST

**File name currently selected**

**RETURN** Returns to previous screen.

**FILE INFORMATION** Displays the system information of the selected file.

**DETAIL** Displays the system information of the selected file.

**COPY** Copies the selected file.

**DELETE** Deletes the selected file.

**RENAME** Renames the selected file.

FILE	SIZE	DATE
ALARM	<DIR>	02/12/31 10:00
CAPTURE	<DIR>	02/12/31 10:00
DATA	<DIR>	02/12/31 10:00
FILE	<DIR>	02/12/31 10:00
LOG	<DIR>	02/12/31 10:00
MRM	<DIR>	02/12/31 10:00
SRAM	<DIR>	02/12/31 10:00
TREND	<DIR>	02/12/31 10:00
BK2266.MEM	8913920	02/12/31 11:15
GPBACKUP.INF	24	02/12/31 11:14
IPL.SYS	30880	00/ 5/26 01:00
MLD2266.SYS	786464	02/11/11 02:00

SPACE OF CF\_CARD: 21626 Kbytes

FILE INFORMATION  
TYPE: GP2500  
COMMENT:  
A PLANT SYSTEM

#### ■ FILE COPY

Touch the **COPY** button on the [FILE LIST] screen. The following screen appears.

**ENTER** Cancels the file copy operation.

**RETURN** Cancels the file copy operation.

**CHANGE** Confirms the source and destination and executes the copy operation.

**CHANGE** Designates the destination folder.

**CHANGE** Designates the destination file.

**The folder name and file name of the currently selected file are displayed as "SOURCE".**

FILE COPY

ORIGIN OF COPY







FOLDER : ¥

FILE : BK2266.MEM

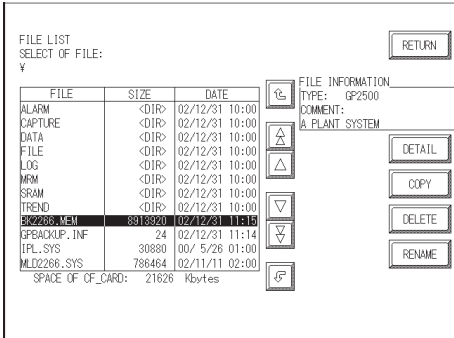
COPY POINT

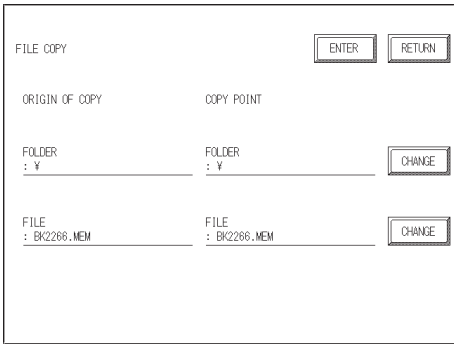
FOLDER : ¥

FILE : BK2266.MEM

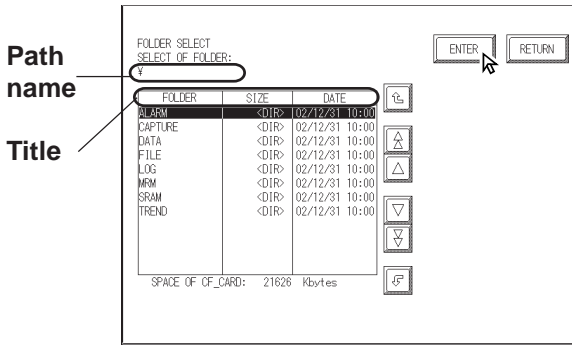
PROCEDURE	REMARKS
<p><b>(1) Touch [5 FILE LIST] on the Memory Loader Tool Menu screen.</b> The file list screen appears.</p>  <p>The screenshot shows a 'FILE LIST' screen with a table of files. The table has columns for FILE, SIZE, and DATE. The file 'BK2266.MEM' is highlighted. To the right of the table are several control buttons: a folder icon, a magnifying glass, a left arrow, a right arrow, a down arrow, and a file icon. Below the table, there is a 'FILE INFORMATION' section with fields for TYPE (GP2500), COMMENT (A PLANT SYSTEM), and buttons for DETAIL, COPY, DELETE, and RENAME. At the bottom, there is a 'SPACE OF CF_CARD' field showing 21626 Kbytes.</p>	<p>Enter the password you have registered in the GP-PRO/PBIII's [Transfer] screen. If you have not registered a password, simply touch [START] and data download will start.</p>
<p><b>[To copy a file]</b></p> <p><b>(2) Touch  to call up the file copy screen.</b></p>  <p>The screenshot shows a 'FILE COPY' screen. It has fields for 'ORIGIN OF COPY' and 'COPY POINT'. Below these are fields for 'FOLDER' and 'FILE', each with a 'CHANGE' button. At the top right are 'ENTER' and 'RETURN' buttons. The 'FOLDER' field contains 'Y' and the 'FILE' field contains 'BK2266.MEM'.</p>	
<p><b>(3) Touch  for the destination folder, select the folder name, and touch .</b> To cancel the file copy, touch .</p>  <p>The screenshot shows a 'FOLDER SELECT' screen with a table of folders. The table has columns for FOLDER, SIZE, and DATE. The folder 'SUB1' is highlighted. To the left of the table, there are two annotations: 'Path name' pointing to the 'FOLDER' column header and 'Title' pointing to the 'SUB1' folder name. To the right of the table are control buttons: a folder icon, a magnifying glass, a left arrow, a right arrow, a down arrow, and a file icon. At the bottom, there is a 'SPACE OF CF_CARD' field showing 21626 Kbytes.</p>	

The displayed path name is limited to 30 characters. The 31st and subsequent characters are omitted.

A maximum of 50 file names can be displayed.

Touching the column heading (FOLDER/SIZE/DATE) sorts the displayed file names in ascending order according to the heading selected.

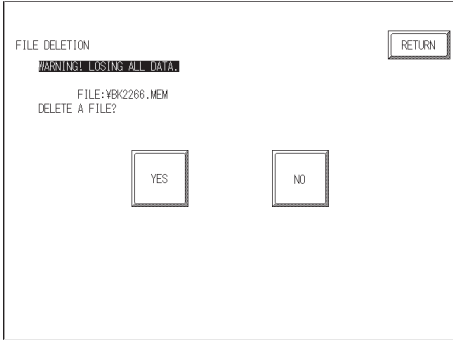
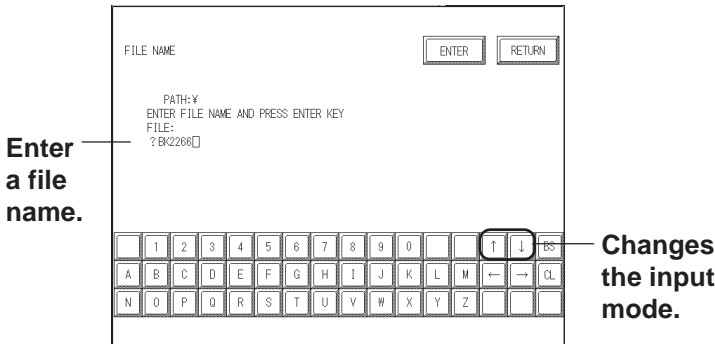
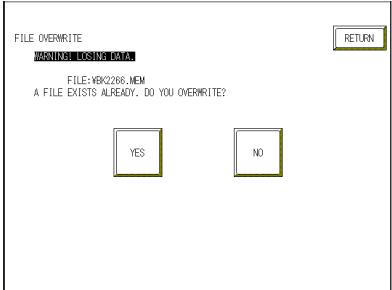
PROCEDURE	REMARKS
<p><b>[To delete a file]</b></p> <p>(2) Touch <b>DELETE</b> to call up the file delete screen.</p> <p>Confirm the file name to be deleted and touch [YES]. To cancel the file deletion, touch [NO].</p>  <p><b>[To change a file name]</b></p> <p>(2) Touch <b>RENAME</b> to call up the file name input screen.</p> <p>Enter the file name and touch <b>ENTER</b>. To cancel the file renaming, touch <b>RETURN</b>.</p>  <p>(3) Enter your password using the screen's keypad.</p> <p>(4) Touch [START] and data download will begin.</p>	<p>The file deletion cannot be undone after [YES] is touched.</p> <p>The displayed path name is limited to 30 characters. The 31st and subsequent characters are omitted.</p> <p>Up to eight single-byte alphanumeric characters can be used for the file name. The file extension cannot be changed.</p> <p>The input mode can be changed in this order: single-byte alphanumeric (uppercase) → single-byte alphanumeric (lowercase) → numbers and symbols.</p> <p>If the entered file name already exists in the CF Card, the following message will appear to confirm the overwrite operation.</p> 



**10.7.5 Self Diagnosis**

You can check the CF Card's "CF Memory Loader Tool" using the OFFLINE mode's SELF DIAGNOSIS area. For example, if you touched three corners of the GP screen, selected [CF BOOT] on the Menu Bar and the CF Card failed to operate correctly, you can check the status of the "CF Memory Loader Tool" (i.e. IPL.SYS, MLD\*\*\*\*.SYS) with this feature.

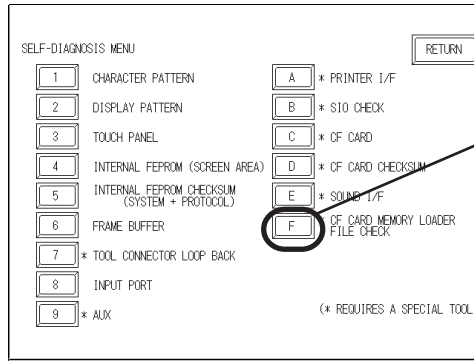

**Calls up the CF Card Memory Loader file check screen.**

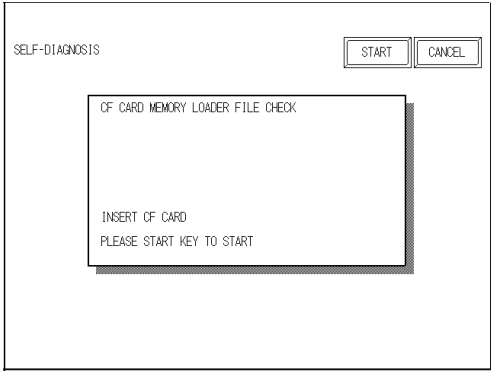
PROCEDURE	REMARKS
<p><b>(1) Touch [CF CARD MEMORY LOADER FILE CHECK] and the following screen will appear.</b></p> 	
<p><b>(2) Touching [START] checks the following points.</b></p> <ul style="list-style-type: none"> <li>• The status of the CF Card Start Dip Switches</li> <li>• Whether the "CF Memory Loader Tool" is in the CF Card or not</li> <li>• If the CF Memory Loader program has errors</li> </ul>	



# *Memo*

**T**he Project Manager can display the hierarchical structure of Project Files and screens. This function enables you to easily view Project Files and screens when moving or copying. This chapter describes how to operate the Project Manager in the hierarchical display mode.

**11.1 ..... Project Manager - Hierarchical Display**

**11.2 ..... Using Hierarchical Display Mode**

# 11.1 Project Manager - Hierarchical Display

When you click on the  button or select the [Project] menu - [Change Project Manger] command of the Project Manger in the normal display mode, the Project Manager is switched to the hierarchical display mode. To return to the Project Manager's original display, select the [Project] menu - [Change Project Manager], or click on the  icon.

When the Project Manager is in the hierarchical display mode, the hierarchical structure of your personal computer's folders is displayed, and the folders/Project Files are listed.

Normally, the system displays the hierarchical structure of the Database folder where the GP-PRO/PB III program has been installed. When you select the [View] menu - [Show Folders] command, all folders stored in your personal computer can be displayed.

Project files are displayed as folders. Screens are located in each folder corresponding to the screen type. You can open a desired screen by simply double-clicking the screen name. The project file folder is indicated by the project file name and the specified Device/PLC type. Each screen name is displayed with comments, size, and the date/time of creation or edition.

When you double-click on a folder in the left box of the Project Manager, the contents of the folder will be displayed in the right box.

When you click on the [+] (plus) sign at the left of each folder, its sub folders will be displayed.

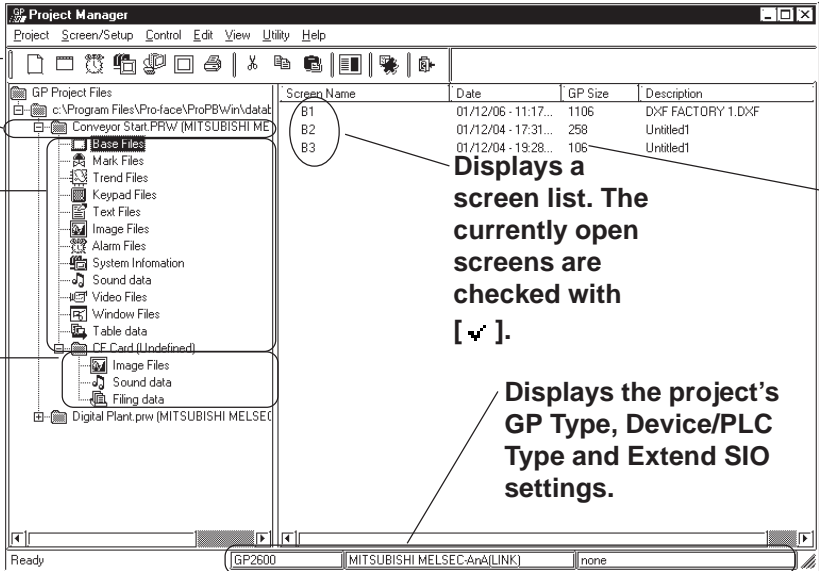

**Tool Bar**  
Displays Project Files

**Displays a Project's individual screen type Files**

**Displays the data stored in the CF card data output folder**

Screen Name	Date	GP Size	Description
B1	01/12/06 - 11:17...	1106	DXF FACTORY 1.DXF
B2	01/12/04 - 17:31...	258	Untitled1
B3	01/12/04 - 19:28...	106	Untitled1

**Displays a screen list. The currently open screens are checked with [✓].**

**The screen necessary for transfer is described in [\*0].**

**Displays the project's GP Type, Device/PLC Type and Extend SIO settings.**



**If the Project Manager has been changed during the transfer of a screen to the GP unit, the transfer will be aborted. Do not change the Project Manager during the transfer of any screen.**

- To change the size of the left/right box displayed in the window, drag the border line between these boxes.
- In the system information holder, a system information screen is displayed. Each system information screen can be copied to another project file by simply dragging it over that file's icon.

## 11.2 Using Hierarchical Display Mode

This section describes the basic operations of the Project Manager in the hierarchical display mode.

### ■ Creating a New Project

Click on the folder where you wish to create a new Project File. Select the [Project] menu - [New] command, or click on the  icon. The [New] dialog box will appear.

#### ▼ **Reference** ▲ 1.1.2 ■ *Creating a New Project*

When a new Project File is created, a new folder “(new\_project\_name).prw” will be added to the directory.

### ■ Selecting a Project File from the Existing Projects

Click on the Project File to be selected. The right box lists the folders of the selected Project File by screen type.

### ■ Rename

To change a Project File name or screen name, select the target Project File or screen, and then select the [Project] menu - [Rename] command.

### ■ Opening a New Screen

Select a Project file. And then select the [Screen/Setup] menu - [New] command, or click on the  icon. The [New] dialog box will appear. Select the type of screen to be created and click on the  button. Then, a new screen will open.

#### ▼ **Reference** ▲ 1.1.3 ■ *Opening a New Screen*

### ■ Opening an Existing Screen

Select a Project file to create a screen. When selecting the [Screen/Setup] menu - [New] command, with the screen type folder specified, the [New] dialog box will appear with the specified screen type selected. Then, click on the  button to open a new screen.

### ■ Opening a Screen

When you select the Project File including the target screen and then click on the folder corresponding to the target screen type, the screen name will be displayed at the right of the box. When you double-click on the target screen name, the Screen Editor will start up, and the selected screen will be opened. After selecting a desired screen, select the [Screen/Setup] menu - [Editor] command, or click on the  icon to open the screen.

When clicking on the  icon with the Project File selected, a dialog box to open a screen will appear. Select a desired screen and click on the  button.

### ■ Copy

Select the target Project File or screen, and drag it to the destination folder. You can also copy it by selecting the [Edit] menu - [Paste] command after selecting the target Project File or screen and specifying the destination folder.

However, to copy a “screen type” folder or screen, drag it to a “Project File” folder or a folder of the same screen type.

### ■ Delete

Select the target Project File or screen, and then press the  key or select the [Project] menu - [Delete] command.



**If any project file has been edited by copying/deleting its data with the Windows Explorer, this edit will not be reflected in the hierarchical display of the Project Manager. In this case, update the details of the hierarchical display by selecting the [View] menu - [Refresh] command.**

**S**creen data created with other screen editor software can be converted into files that can be used with the GP-PRO/PB III for Windows program.

**12.1 ..... File Converter**

# 12.1 File Converter

Files created with other screen editor software (such as GP-PRO , GP-PRO II, GP-PRO III, and Parts Box) can be converted into files for use with the GP-PRO/PB III for Windows program. Reversely data created with GP-PRO/PB III for Windows program cannot be converted into data for use with GP-PRO, GP-PRO II, GP-PRO III, Parts Box and GP-PRO/PBIII (DOS version).



- Conversion to data for LT series is impossible.
- Project Files created with the GP-PRO/PB III program (DOS version) need not be converted. You can simply open your DOS files on the GP/PRO III for Windows program by selecting “DOS Project File (\*.pro)” when specifying the project file type. Once you save these files with the GP/PRO III for Windows program, they can be used with Windows.



**Reference** 1.1.2 ■ Selecting an Existing Project, ■ Saving a Project

The screenshot shows the 'File Converter' dialog box with the following callouts:

- Displays the original file to be converted:** Points to the 'Input File:' text box.
- Displays a new file name and a comment:** Points to the 'New File Name:' and 'New File Description:' text boxes.
- Displays the current conversion status:** Points to the 'Processed Files:' list box.
- Displays the conversion progress:** Points to the 'Conversion Status:' progress bar.

## 12.1.1 Conversion from GP-PRO II or GP-PRO III

Here, files created via GP-PRO II or GP-PRO III are converted to GP-PRO/PB III project files (\*.PRW files).

Usage Pattern				
[Start] → [Program] → [Pro-face] → [PROPB3Win] → [File Converter] →				
[File]	→	[Convert From GP-PRO 2/3 File]	→	Select a file created with GP-PRO II or III.
or		Click on 	→	Specify the conversion range of the file.
[Actions] → [Convert]				
or				
Click on  to execute the conversion.				



■ **Selecting a GP-PRO II/III File**

The screenshot shows the 'Convert From GPPRO2/3' dialog box. The 'Look in:' field is set to 'ProPB3Win'. A file list contains folders like 'cpk', 'cpw', 'database', 'Gpo', 'keylib', 'mk', 'pbwguide', 'pdb', 'plcbl', 'protocol', 'psto', 'pto', 'sheet', and 'sto'. The 'Device/PLC Type' is set to 'MEMORY LINK SIO Type (\*.DLM)'. Below the file list is a 'Files to Convert' section with buttons: 'Add All', 'Add >>', '<< Remove', and 'Clear All'. An arrow points from the 'Add All' button to the text 'Selects all the GP-PRO II and III screen files listed'. Another arrow points from the 'Add >>' button to 'Selects the screen file selected from the list'. A third arrow points from the '<< Remove' button to 'Cancel selection of the specified screen file'. A fourth arrow points from the 'Clear All' button to 'Cancel selection of all screen files'. A fifth arrow points from the 'Device/PLC Type' dropdown to 'Displays the Device/PLC type specified for the GP-PRO II or III file'. A sixth arrow points from the 'Files to Convert' list to 'Lists the selected screen files'.







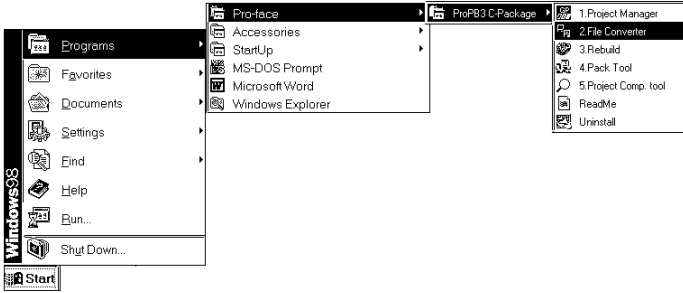

◆ **Selecting a Destination Folder**

Designate a name for the Project File (PRW file) created when the GP-PROII or GP-PROIII file is converted.

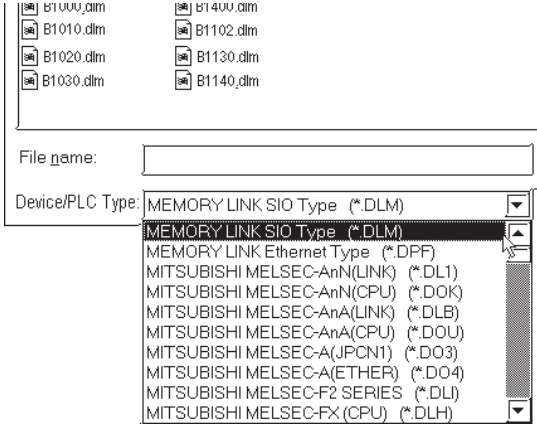

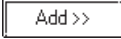
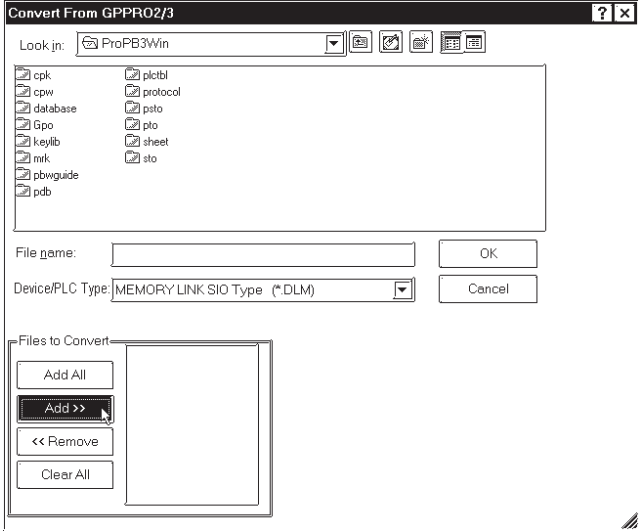
The screenshot shows the 'Convert To:' dialog box. The 'Look in:' field is set to 'ProPB3Win'. A file list contains folders like 'protocol', 'psto', 'pto', 'sheet', 'sto', 'cpk', 'cpw', 'database', 'Gpo', 'keylib', 'mk', 'pbwguide', 'pdb', and 'plcbl'. The 'Files of type' is set to 'Windows Project Files (\*.prw)'. The 'Display Type' is set to 'GP270L'. The 'Device/PLC Type' is set to 'MEMORY LINK SIO Type'. The 'Conversion Type' section has two options: 'New / Replace' (selected) and 'Merge'. An arrow points from the 'New / Replace' option to the text 'Creates a new Project File'. Another arrow points from the 'Merge' option to the text 'Adds screen data into a Project File with the same file name and saves it.'.

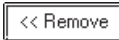
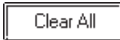
■ Converting a GP-PRO II/GP-PRO III File

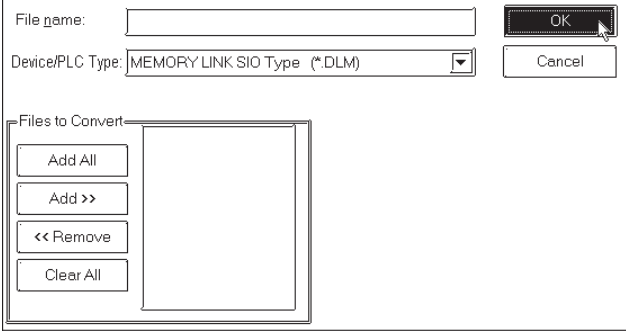
PROCEDURE	REMARKS
<p>(1) Click on the [Start] button, and point to the [Program ] - [Pro-face] - [ProPB3 C-Package] menu. Then, click on the [2.File Converter] command.</p>  <p>(2) Select the [File] menu - [Convert From GP-PRO 2/3 File] command, or click on the  icon.</p> <p>(3) Select a desired GP-PRO II or GP-PRO III file's Device/PLC type. The files corresponding to the selected Device/PLC type will be displayed.</p> 	

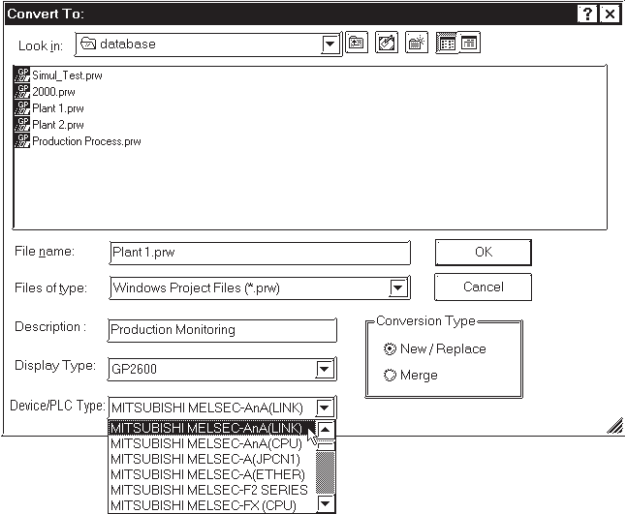
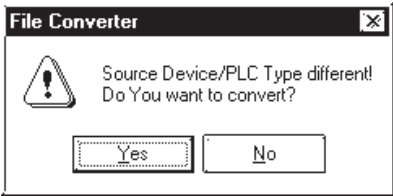
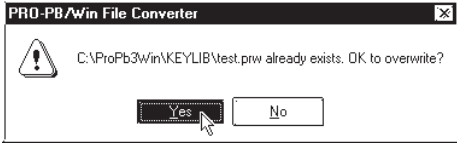
PROCEDURE	REMARKS
<p><b>(4) Select a desired GP-PRO II or GP-PRO III file or enter the file name, and click on the  button.</b>                      The selected file will appear in the Files to Convert list.</p> 	<p>To convert all files, click on the  button.</p> <p>To cancel file selection, click on the  or  button.</p>
<p><b>(5) After selecting the GP-PRO II or III file, click on the  button.</b></p> 	

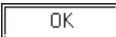
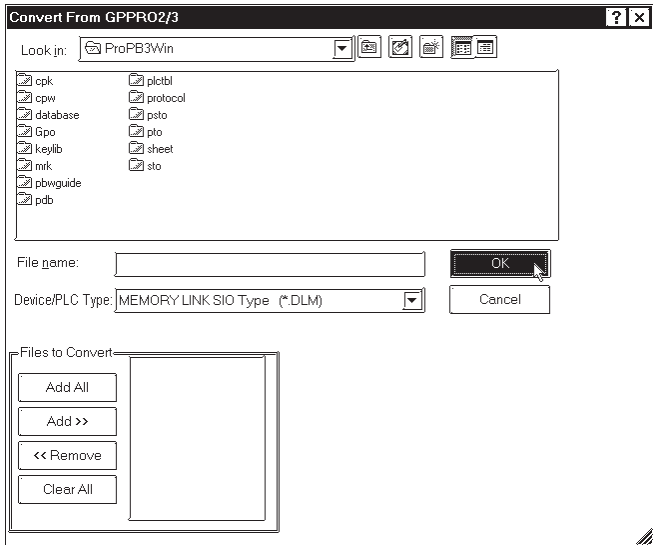
PROCEDURE	REMARKS
<p>(6) Enter the folder and Project File name where the converted file will be stored. Also, specify the GP and Device/PLC types.</p> <p>If the Device/PLC types are different before and after conversion, a dialog box will appear confirming the conversion command. If you wish to convert the file, click on the <input type="button" value="OK"/> button.</p>  <p style="text-align: center;">↓</p>  <p>(7) After confirming the conversion command, click on the <input type="button" value="OK"/> button.</p>	<p>To import a file from a different folder, first change the folder.</p> <p><b>Reference 1.1.2 ■ Selecting an Existing Project</b></p> <p><b>[Display Type]</b> Select the GP unit type for the target Project File.</p> <p><b>[Device/PLC Type]</b> Select the Device/PLC type for the target Project File.</p> <p><b>When the destination Project file's Device/PLC type is different from that of the original file, you must specify the Tag device address again after the Project File is imported.</b></p> <p>If the same file already exists, the system asks if this file must be overwritten. If you select <input type="button" value="Yes"/>, the file will be overwritten. If you select <input type="button" value="No"/>, the file will not be overwritten, and you will return to the previous dialog box.</p> 

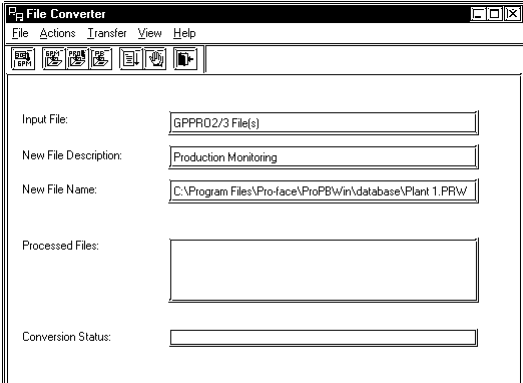
PROCEDURE	REMARKS
<p>(8) Click on the  button to confirm the original and destination file settings.</p> 	
<p>(9) After confirming the settings, select the [Actions] menu - [Convert] command, or click on the  icon. The current status of the file conversion will be displayed. When the file conversion has been completed, “DONE” will be displayed in the status display area.</p> 	





- After importing the system (SO) screen from GP-PRO II or GP-PRO III, be sure to check the [System Settings] data.
- When the system (SO) screen imported by the [Convert From GP-PRO 2/3 File] command is transferred to the GP70/77R/2000 series unit, you will need to perform [Font Setup]. Enter the GP’s OFFLINE mode, and set up the necessary fonts (language).

**Reference** *GP Series User’s Manual (sold separately), FONT SETTINGS*

**12.1.2 Conversion from Parts Box**

Here, system files (SCD file) created via Parts Box are converted to GP-PRO/PBIII project files (\*.PRW).

<b>Usage Pattern</b>		
[Start] → [Program] → [Pro-face] → [ProPB3win] → [2.File Converter] →		
[File] → [Convert From Parts Box]	→ Select a file created with Parts Box.	→ Specify convert destination.
or click on 		
[Actions] → [Convert]		
or		
Click on  to execute the conversion		

**■ Selecting a Parts Box File**

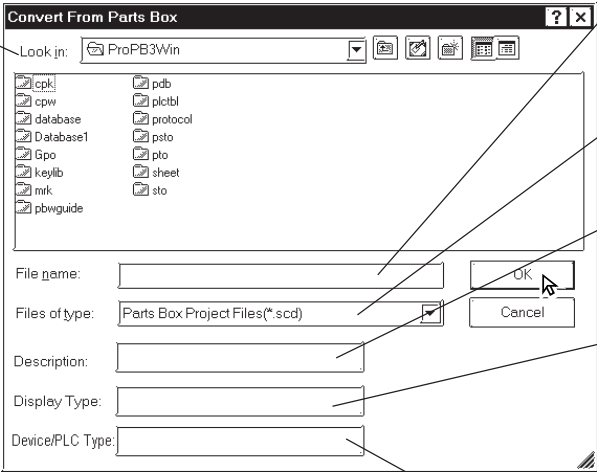

**Displays the destination Project File (PRW file)**

**Select the SCD File and CPL File created with Parts Box**

**Displays Parts Box's system file (SCD file) and Library file (CPL file).**

**Displays a comment attached to the SCD or CPL file.**

**The Easy series name is automatically converted into the following GP series names :**  
 [Easy20]: GP-270 series  
 [Easy40/50] : GP-470 series

**Displays the Device/PLC type of the system file (SCD file)**







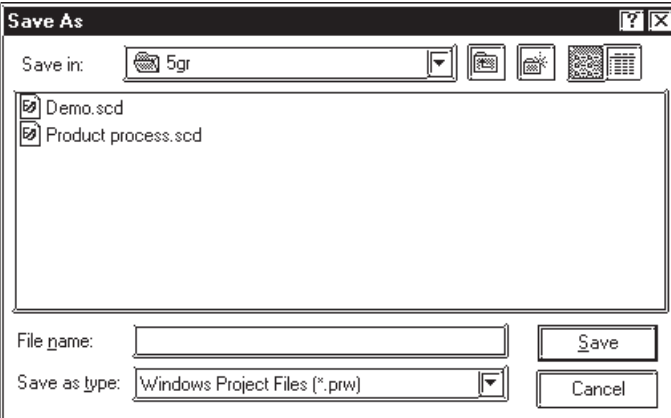

**◆ Selecting a Destination Folder**

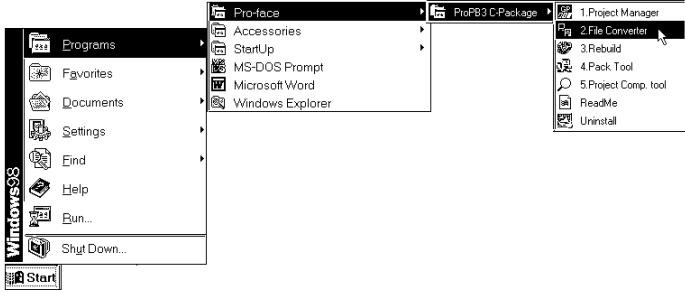
Specify the destination folder to store the Project File (PRW file) converted from the SCD file and CPL file.

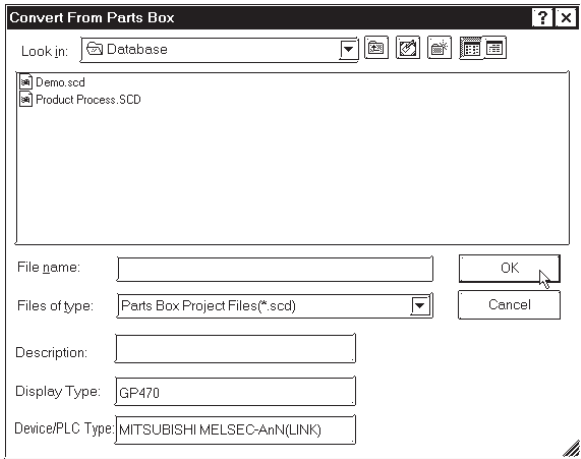

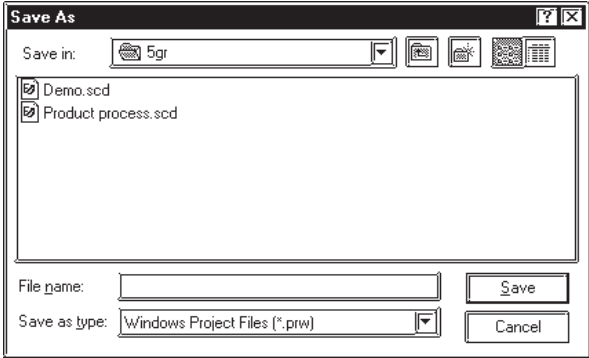
■ Converting a Parts Box File

PROCEDURE	REMARKS
<p>(1) Click on the [Start] button, and point to the [Program] - [Pro-face] - [ProPB3 C-Package] menu. Then, click on the [2.File Converter] command.</p> 	
<p>(2) Select the [File] menu - [Convert From Parts Box] command, or click on the  icon.</p>	
<p>(3) Select a Parts Box file to be converted or enter the file name, and click on the <input type="button" value="OK"/> button.</p> 	<p>To import a file from a different folder, you must change to that folder.</p> <p><b>Reference 1.1.2 ■ Selecting an Existing Project</b></p> <p>When selecting a Library file (CPL file), select [Parts Box Library File (*.cpl)] in the Files of type pull-down list.</p> 
<p>(4) Enter the folder and Project file name where the converted file is saved, and click on the [Save] button.</p> 	<p>If you wish to change the GP and Device/PLC type for the destination file, make the change after executing the conversion.</p> <p><b>Reference 4.2.6 Changing a Project's GP Type and 4.2.7 Changing Your Project's Device/PLC Type and Addresses</b></p>

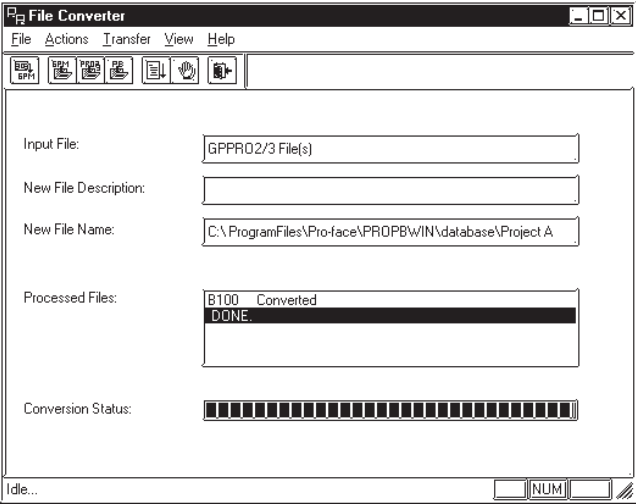

PROCEDURE	REMARKS
<p>(5)After confirming the settings, select the [Actions] menu - [Convert] command, or click on the  icon. The current status of the file conversion will be displayed. When the file conversion has been completed, “DONE” will be displayed in the status display area.</p> 	



### 12.1.3 GP-\*10 (GPM) File Conversion

Here, the GP-\*10 Series' memory card data (GPM file) is converted to GP-PRO/PBIII's Project file (PRW file) for each memory card. Files created via GP-PRO cannot be converted directly to PRW files. First create GPM files, and then convert them to PRW files.

#### **Reference** 12.1.4 Reading GP-\*10 (GPM) Files

Usage Pattern
<p>[Start] → [Program] → [Pro-face] → [ProPB3Win] → [2.File Converter] → [File] → [Select GP x 10 (GPM) File]</p> <p>or click on  → Select a GP-PRO file. → Specify conversion destination.</p> <p>[Actions] → [Convert]</p> <p>or</p> <p>Click on  to execute the conversion</p>

#### ■ Screen Data After Conversion

##### ◆ Screen names

After converting screen data created via GP-PRO to GP-PRO/PBIII screen data, the converted screen names are changed as follows:

Screen Type	GP-PRO	GP-PRO/PBIII
Base screen	1 to 255	B1 to B255
Library screen	300 to 699	B300 to B699
Mark screen	700 to 999	M700 to M999
Trend Graph screen	1000 to 1199	T1000 to T1199
Alarm Message	1200 to 1299	A1200 to A1299*

\* For converted alarm messages, be sure to check row 1200 and later in the alarm editor.

##### ◆ Tag names

Tag names will not be changed even after conversion. However, for l-tag and m-tag, "L" and "M" will be attached to the beginning of the original tag name, respectively.

#### ■ Cautions When Converting GP-PRO Files

When converting GP-PRO files, be aware of the following cautions:

##### • Object displacement

Due to the high speed drawing of arcs and pies, as well as differences of drawing algorithms, GP-\*10 screen coordinates data will be optimized. As a result, objects may be displaced from their original positions, which requires modification and correction.

##### • Color settings

Since color settings designated as "black + blink" are converted to "white + blink", re-set the color.

- **Chinese character fonts**

Chinese character fonts used on the GP-\*10 series are different from the ones on the GP70/GP77R/GP377/GP2000 Series units.

- **Numeric Keypad Input**

- **N699-tag**

The GPPRO/PB III does not feature N699-tags. After conversion, re-create numeric keys and display on the GP-PRO/PBIII.

- **k-tag**

When converting GP-PRO files while two or more k-tags are set for one screen, all the k-tags are displayed in the center of the screen being overlaid. After conversion, rearrange the tags so that they are displayed in the correct positions.

- **K-tag**

Since GP-PRO does not have a function to display data for K-tag, N-tag is used to enter set values via the screen's numeric keys. However, since GP-PRO/PB III supports the K-tag display function, the N-tag settings are not required.

- **System data areas +6 and +7**

The GP-\*10 Series uses system data areas +6 and +7 for N699-tag numeric key entry and K-tag. However, the GP70/GP77R/GP377/GP2000 Series use +6 for status and +7 for reserved area, and K-tag reads and writes PLC data directly, without using the system data areas. When system data areas +6 and +7 have been used for the tags or ladder program, correct the address settings.

- **Requirements for 32-bit data**

Relationship between 32-bit data upper and lower addresses may be different between the GP-\*10 Series and the GP70/GP77R/GP377/GP2000 Series, depending on Device/PLC types. Due to this, the PLC's ladder program may require correction.

- **Device/PLC type**

GP-\*10 Series unit project files created for the following PLC units can be converted to GP-PRO/PBIII.

- MEMORY LINK SIO Type
- SHARP JW Series
- YOKOGAWA FA500 Series
- FUJI MICREX-F Series
- TOYOTA TOYOPUC Series
- YASUKAWA Memocon-SC GL Series
- HITACHI HIDIC-S10 / HIZAC H Series
- TOSHIBA PROSEC Series
- MATSUSHITA MEWNET-FP Series
- MITSUBISHI MELSEC-AnN Series / AnA Series / F Series / FX Series

Series

- KOYO KOSTAC Series
- OMRON SYSMAC-C Series

However, if the project file was created for a TOYOTA TOYOPUC PC1, YASUKAWA Memocon-SC GL20, or TOSHIBA PROSEC EX Series PLC (exception : EX2000 projects can be converted directly), they

cannot be converted directly. To convert them, please choose another destination target unit.

- **Data check after conversion**

Be sure to check all the settings such as of tags, after conversion.

### ■ Selecting a GPM File

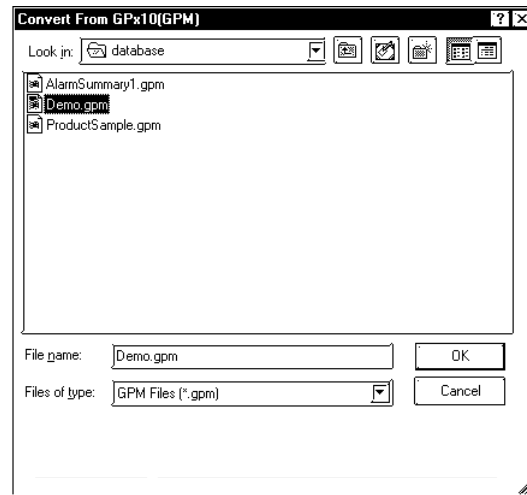

### ◆ Conversion destination

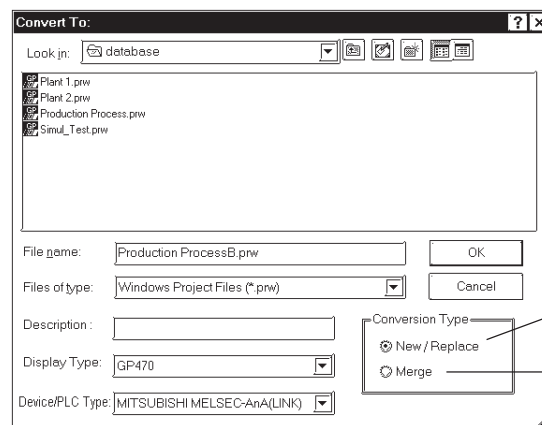

Specify the folder used to save the Project file (PRW file) converted from a GPM file.



Creates a new Project file.

Overwrites or adds screen data to the existing Project file with the same name.

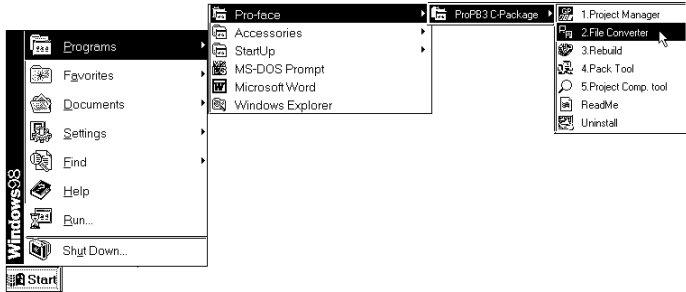
■ Converting a GPM File

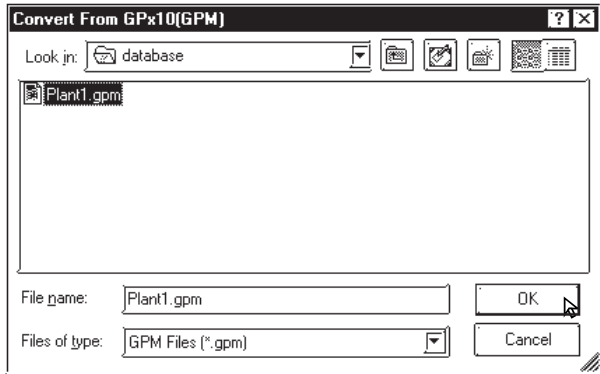
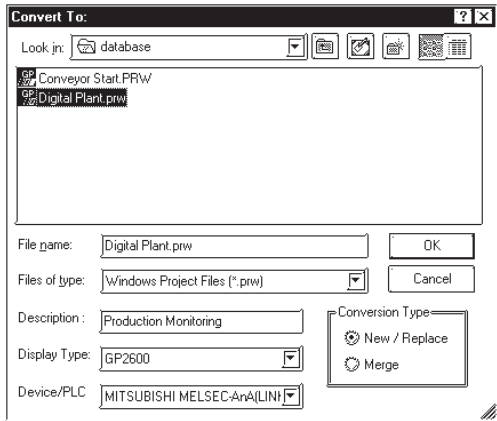
PROCEDURE	REMARKS
<p>(1) Click on the [Start] button and then select [Program] - [Pro-face] - [ProPB3 C-Package] - [2. File Converter].</p> 	
<p>(2) Select the [File] menu - [Select GP x 10 (GPM) File] command, or click on the  icon.</p>	
<p>(3) Select a GPM file to be converted or enter the file name, and click on the <input type="button" value="OK"/> button.</p> 	
<p>(4) Enter the folder and Project file name where the converted data is stored. Also, specify GP and Device/PLC types.</p> 	<p>To import a file from another folder, change the folder.</p> <p><b>Reference 1.1.2 ■ Selecting an Existing Project</b></p> <p><i>When the destination Project file's Device/PLC type is different from that of the original file, you must designate all Tag device addresses again, after the Project File is imported.</i></p>

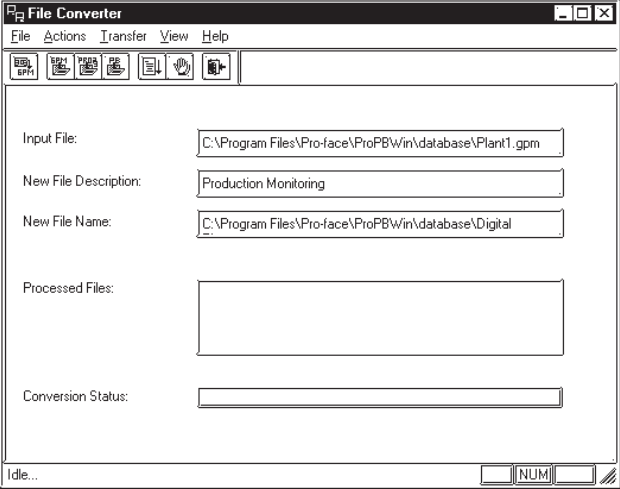
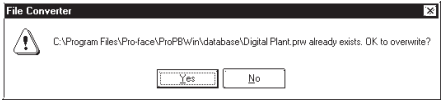
PROCEDURE	REMARKS
<p>(5) After confirming the settings, click on the <input type="button" value="OK"/> button.</p> <p>(6) After confirming the settings, select the [Actions] menu - [Convert] command, or click on the  icon. The conversion status will continuously be displayed. When "Completed" is displayed in the [Status] field, conversion is completed.</p>	<p>If the same file already exists, the system asks if this file must be overwritten. If you select <input type="button" value="Yes"/>, the file will be overwritten. If you select <input type="button" value="No"/>, the file will not be overwritten, and you will return to the previous dialog box.</p>
	

**12.1.4 Reading GP-\*10 (GPM) Files**

Screen data transferred to the GP-\*10 is received as GPM files. The received data files can be converted to GP-PRO/PB III Project files (PRW files) and used.

**Reference** 12.1.3 GP-\*10 (GPM) File Conversion



- **A connector adapter is required to use a PC unit with a D-sub 9-pin socket interface.**  
**Using a commercially available conversion adaptor is recommended. The wiring for a standard-type conversion adaptor is shown below.**

**Ex.) ARVEL Corporation's RS-232C Conversion Adaptor Model: AA830**

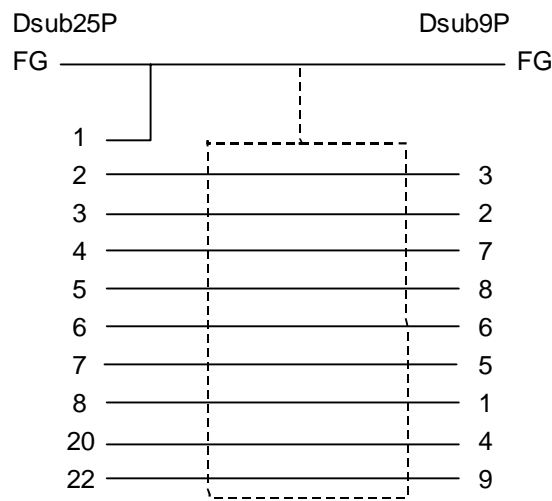

Usage Pattern			
[Start]	→	[Program]	→
		[Pro-face]	→
		[ProPB C- Package]	→
		[2.File Converter]	→
[Transfer]	→	[Load GPM File From GPx10]	→
or		click on 	→
		Perform storage destination and communication settings.	→
		Click on <input type="button" value="Yes"/> to execute the conversion.	

■ Reading a GPM File

PROCEDURE	REMARKS
-----------	---------

(1) Click on the [Start] button and select [Program] - [Pro-face] - [ProPB3 C-Package] - [2. File Converter].

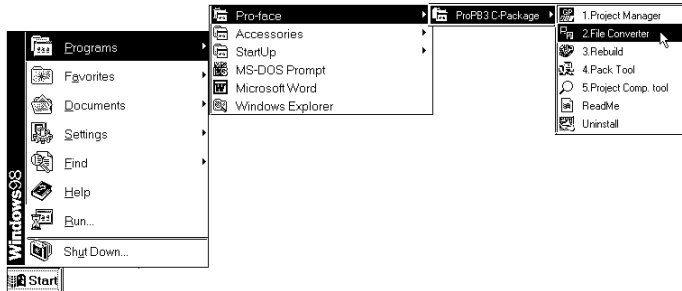

To receive data, connect the GP and personal computer via a cross cable.

Digital's GP410-IS00-0 is available.

Also, set the GP to transfer mode using the keyboard for drawing objects.

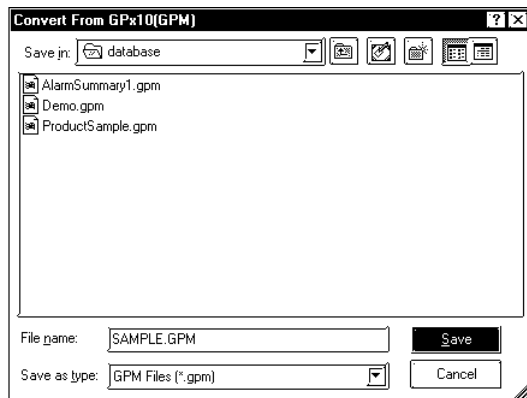

(2) Select the [File] menu - [Load GPM File From GPx10] command, or click on the  icon.

(3) Specify a location (directory) to store the received data and the file name, and click on the  button.

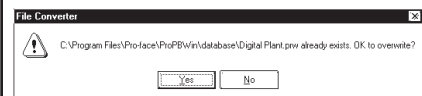

If the same file already exists, the system asks if this file must be overwritten. If you select , the file will be overwritten. If you select , the file will not be overwritten, and you will return to the previous dialog box.

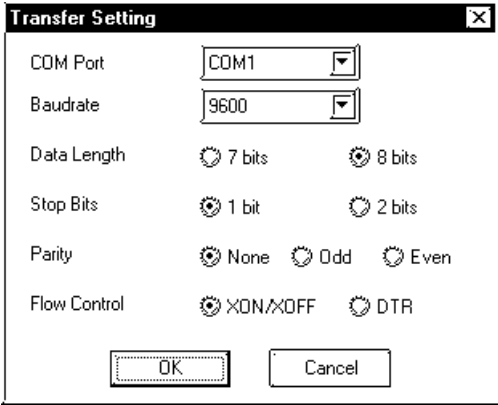
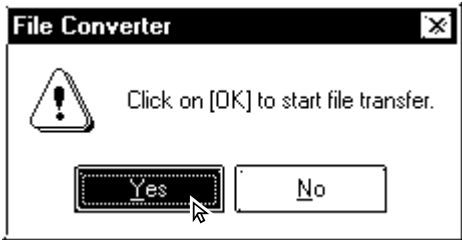

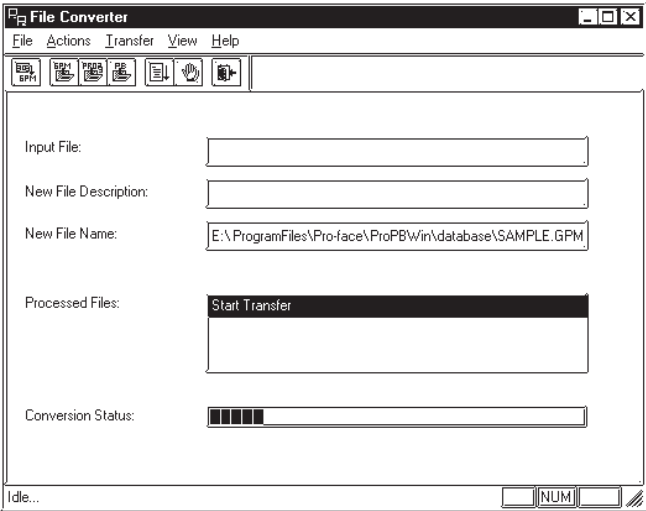
PROCEDURE	REMARKS
<p>(4) Specify all the necessary communication items and click on the <input type="button" value="OK"/> button.</p> 	<p><i>The communication settings must be the same as the GP's initial SIO settings.</i></p> <p>Sending Speed: 9600 bps                  Data Length: 8-bit                  Stop bit: 1-bit                  Parity bit: None                  Control Type: XON/XOFF</p>
<p>(5) Click on the <input type="button" value="Yes"/> button to start receiving data.</p> 	
<p>(6) After confirming the data receiving command, select the [Actions] menu - [Convert] command, or click on the  icon.</p> <p>The conversion status will continuously be displayed. When "Completed" is displayed in the [Status] field, conversion is completed.</p> 	



# APPENDICES

**T**his section contains a list of error messages and corrective actions, as well as address conversion tables.

<b>Appendix 1</b>	.....	<b>Error Messages</b>
<b>Appendix 2</b>	.....	<b>Troubleshooting</b>
<b>Appendix 3</b>	.....	<b>Address Conversion Tables</b>
<b>Appendix 4</b>	.....	<b>Software Trouble Report</b>

## A.1 Error Messages

### ■ Project Manager Errors

	Error Message	Cause/Solution
B	Because of the change in PLC type, a part of the device address used in the project may be converted into a device address that cannot be used with the current PLC. Double-check all device addresses used in the project and modify them as required.	This warning message is displayed every time an attempt is made to change the Device/PLC type and addresses. Double-check all device addresses used in the project and modify as necessary.
	Be sure to check with the Network Coordinator to confirm your unique IP address. This is because if a duplicate IP address is used by any user, the entire network can be effected.	Click in the node IP address' edit box. Be sure to enter the node IP address carefully so that it does not duplicate any other device IP addresses.
C	Can't edit - Insufficient memory	The memory area for editing is insufficient. Quit other applications, then begin editing your file again.
	Cannot edit the files because the filing mode [Use Multiple Folders] setting is not selected! Click on [Use Multiple Folders].	When the filing mode settings' [Use Multiple Folders] was not selected, you attempted to open 2 or more kinds of filing data directly from the Project Manager having nesting screen display by double-clicking. Select [Use Multiple Folders].
	Cannot start up Internet browser	The browser settings are not correct or the memory area for the browser is insufficient. Check the settings of the startup browser. If the browser settings are correct, quit all other applications and restart the browser.
	Cannot read system file	The program file data required for setup cannot be opened or read, or the file's data is not correct. The file may be corrupt, or a disk error may have occurred. After solving the problem, reinstall the file.
	Cannot read the file's system information	The project file is corrupt. Use GP-PRO's rebuilding tool to repair the file. After repair is completed, read the file again.
	Channel numbers overlap!	Be sure channel numbers do not overlap and are unique.
	Current Color Depth Not Supported Convert to 256 colors or less	Only images of 256 colors or less can be used by this software.
	Current GP type does not support Device Monitor feature	Select a GP type which supports the device monitor feature.
	Current Device/PLC type does not support Device Monitor feature	Select a Device/PLC type which supports the device monitor function.
D	Destination screen number is too high. Reduce the number of destination or source screens	Set (Copy source end number - copy source start number) >= (8999 - copy destination start number).
E	Exceeds Data Backup Area Limit. Please adjust your settings to fit this area's size limitations	The backup settings, backup area used cannot exceed 2031. Set the backup start address + the number of devices to less than or equal to 2031.
	Exceeded limit for backup area setting of current GP type. Backup cannot be performed correctly with current setting.	Change the backup area setting to LS4096 or less.
G	Grouping Nesting Limit Reached. Unable to group more than these objects	You are attempting to nest grouped objects more than 10 times. Only 10 levels of nesting are allowed.

	<b>Error Message</b>	<b>Cause/Solution</b>
I	<b>Internet Browser Not Selected Yet. Please select a Browser</b>	An Internet browser has not been selected yet. After clicking on the error message's OK button, select a browser from the dialog box that appears.
	<b>Invalid Address !</b>	Before entering the device address, check that the value is within the allowable range and that the device is supported by the PLC.
	<b>Invalid PLC table</b>	The PLC table file format is readable by the GP, or the file is corrupt or deleted. Select the Device/PLC type from the master disk and reinstall it.
	<b>Incorrect PLC Table Format</b>	The PLC table file format is not the same as the GP's, or the file is corrupt for some reason. Select a Device/PLC type from the master disk and reinstall the file.
N	<b>Non-PRW File</b>	A file has been selected that is not recognized by GP-PRO/PB III for Windows 95. Be sure to only select only Project (.PRW) files.
O	<b>Old PLC table and some functions may not work properly. Please use latest table</b>	The PLC table file from an old version is being used. Select a new Device/PLC type from the master disk and reinstall it.
	<b>Older Version Project File Is it OK to upgrade the file? Upgrading a file means you will not be able to open the old version of the file.</b>	An older version PRW file is now selected. If you click on OK and continue this sequence, the system will upgrade the existing PRW (i.e. create a new file) and change the old PRW's extension to POD. If Cancel is selected, the system leaves the file unchanged.
P	<b>PLC File Type Error</b>	The PLC table file format is not the same as the GP's, or the file is corrupt. Select a Device/PLC type from the master disk and reinstall the file.
S	<b>Screen number to copy from must be greater than screen number to copy to.</b>	Enter a "copy to" screen number that is greater than the "copy from" screen number.
	<b>Selected project is the same as current project.</b>	You cannot copy data within the same project file. Be sure to specify a project file other than the current project file.
	<b>Specified address is not used for screen properties that can be displayed.</b>	When opening the screen via the Global Cross Reference List, designate an address within the valid range of screen addresses.
	<b>System error</b>	The program file data required for setup cannot be opened and read, or the internal data is not correct. The file may be corrupt, or a disk error may have occurred. After fixing the problem, reinstall the file.
	<b>System file is corrupt</b>	The program file data required for setup cannot be opened and read, or the internal data is not correct. The file may be corrupt, or a disk error may have occurred. After fixing the problem, reinstall the file.
	<b>System open error</b>	The program file data required for setup cannot be opened and read, or the internal data is not correct. The file may be corrupt, or a disk error may have occurred. After fixing the problem, reinstall the file.
	<b>System version error</b>	The system cannot open this project file. You are attempting to open a file new version GP-PRO/PB III file using an old version of GP-PRO/PB III.

### ■ Project Manager Errors (from previous page)

	<b>Error Message</b>	<b>Cause/Solution</b>
<b>S</b>	System write error	The program file data required for setup cannot be opened and read, or the internal data is not correct. The file may be corrupt, or a disk error may have occurred. After fixing the problem, reinstall the file.
<b>U</b>	Unable to convert file. Please check disk.	The destination disk does not have sufficient free space. Prepare a disk that has sufficient space and re-try.
	Unable to read current project information	The project file is corrupt. Use the GP-PRO rebuilding tool to repair the file, and then read the file again.
	Unrecognizable Image File may be corrupted	The selected image file is either corrupted or unusable by this software.

### ■ Screen Editor Errors

	<b>Error Message</b>	<b>Cause/Solution</b>
<b>B</b>	Bitmap size is too large. The maximum bitmap size that can be registered is 160x160 pixels.	The maximum size of a bitmap that can be registered as an image Part is 160 dots x 160 dots. Be sure the image registered is within these limits.
<b>C</b>	Can't edit - Insufficient memory	The memory area is insufficient for editing. Quit all other applications and resume editing.
	Can't open more than 20 screens	The screen editor can have up to 20 screens open at one time.
	Cannot place screen on itself	You cannot call the screen being edited.
	Cannot register since this number is already being used by the U screen.	Delete the window screen.
	Change request will exceed maximum number of tags. Changes canceled	This change will exceed the tag upper limit. <b>Reference</b> ■ Number of Tags "2.3 Tags"
(Channel) Alarms cannot be used together with Fill Below Line in a channel setting.	When you attempted to use "Fill Below Line", you set the channel's Alarm feature "ON". Undo Graph Fill and reset the channel.	
<b>D</b>	Device address out of range	When the specified command is performed, the device address exceeds the upper limit. Specify an address within the allowable range.

	<b>Error Message</b>	<b>Cause/Solution</b>
E	Exceeded maximum GP file size. Changes canceled	This change will exceed the screen size upper limit. <b>▼ Reference ▼</b> <i>Screen Size "1.1.3 Screen Types"</i>
	Exceeds A-tag limit	Only one alarm can be used on a single screen.
	Exceeds keypad limit	Only one keypad screen can be called to a Base screen.
	Exceeds a-tag limit	Only one alarm can be used on a single screen.
	Exceeds C-tag limit	Only one time display can be used on a single screen.
	Exceeds file size limit	The screen size exceeds the upper limit, and you cannot create any more graphic data. The last data created will become invalid. Store the screen data, and then open a new screen and call the stored screen using [Load Screen] in the [Draw] menu.
	Exceeds Part Library limit.	If the number of Part Libraries used exceeds the limit, Part Library data cannot be transferred to the GP. Reduce the number of Part Libraries. <b>▼ Reference ▼</b> <i>2.1 Parts, ■ Maximum Number of Automatically Created Part Libraries</i>
	Exceeds R-tag limit	Only up to 30 R tags can be used on a single screen.
	Exceeds the Data Transfer Display limit.	Only one Data Transfer Display can be placed on each screen.
F	Filing displays with the same ID No. cannot be placed on a screen if [Cursor Position Control] is selected.	Multiple filing displays with the same ID No. with [Cursor Position Control] selected cannot be placed on one screen. Either deselect [Cursor Position Control] or change each filing display' ID No. so that the ID Nos. do not overlap.
	File write error	This file cannot be written to the destination media. Please check the designated drive name and directory.
	Fill Below Line can be used when only a single channel has been selected. Please delete any additional channels.	Two or more channels are preset for Fill Below Line. Set only one channel.
G	Grouping Nesting Limit Reached. Unable to group more than these objects	You are attempting to nest grouped objects more than 10 times. Only 10 levels of nesting are allowed.
H	High speed U-tag cannot be used if a standard U-tag is already in place.	Both the U tag and the use/non-use of high-speed settings must be specified. Do not duplicate the settings.
I	Invalid Screen (Number)	Valid screen numbers are between 1 and 8,999. Enter the screen No. again in single-byte characters.
L	Large V tag will not work in the extend mode. Please reset this to the standard mode within the video settings of the GP system setup.	In the GP Setup area, select the Extended Setting tab's Video Settings "Standard Mode" setting.
	Logging Display, CSV Display, K-tag, and Keypad Input Display cannot be placed on a screen simultaneously.	Check whether a Logging display, CSV Display, K-tag or Keypad Input Display has already been placed on the screen.

■ **Screen Editor Errors (from previous page)**

	<b>Error Message</b>	<b>Cause/Solution</b>
O	Only one Q-tag sub display can be used per screen.	When using a Q-tag, the number of sub displays used is limited to 1.
P	Parts and tags are not valid objects.	A library item containing Parts or tags cannot be used in a Picture Display.
S	Screen No. is out of range. Re-enter a different Screen No.	Screen No. used after conversion is out of the Screen No. range. Enter the correct number.
	Small v tag will not work in the standard mode. Please reset this to the extend mode within the video settings of the GP system setup.	In the GP Setup area, select the Extended Setting tab's Video Settings "Extend Mode" setting.
T	The amount entered for the data sampling feature is combined with the number of Trend graph channels created, and their combined total cannot exceed 20.	When 20 channels are preset, the Add button is clicked in the data sampling setting list display dialog box. Delete unnecessary settings so that the total of Trend Graph channel settings and the data sampling settings will be within 20.
	The area available for data sampling has been exceeded. Please re-enter this item's settings.	The storage address used exceeds 2031. Set the storage start address + the number of sampling data to less than or equal to 2031.
	The current GP type setting does not support video. Video tag will have no effect	Select the GP type for the VM Unit.
	The currently selected GP type does not support this type size. This setting is invalid.	Select a model supporting the type size of the integer scales.
	The font used for this text cannot be found. Only font type and color can be changed.	The designated font cannot be found in the PC's Font folder. Either select a different font, or install the desired font.
	The designated screen does not exist.	The screen that you attempted to open cannot be found in this project. Select a screen from different existing project.
	The sum total of all the data saved by the GP's data backup features now exceeds the backup memory unit's limit. Please reduce this amount.	The backup size exceeds the SRAM capacity. Reduce the number of sampling data, or set this item's backup setting to "None".
	There are no screens created for this screen type.	The screen that you attempt to open cannot be created with the specified screen type. Open a new screen.
	This object has a non-black background and may not display properly on the GP. Also, be sure that your loaded screen's center point is aligned with the object (loaded to) screen's center point.	If this screen is used as the screen for the background color, be sure to align its center point correctly with the destination screen.
	This rail number is already in use. Please enter another number.	All rail numbers used on a single base screen must be unique.
	This screen cannot be edited.	Delete the window screen.
This tag does not support portrait mode. Continue anyway?	The vertical type GP does not support the tag that you are attempting to use.	
U	Unrecognizable Bitmap File may be corrupted	The selected bit map file is either corrupted or unusable by this software.
W	When the Extended font is used only Alpha-numeric character can be displayed in the main body of the display machine.	2-byte characters are not compatible with the extended fonts.

■ Library Item Placement / Save Errors

	<b>Error Message</b>	<b>Cause/Solution</b>
<b>G</b>	Grouping Nesting Limit Reached. Unable to group more than these objects	You are attempting to nest grouped objects more than 10 times. Only 10 levels of nesting are allowed.
<b>N</b>	Not a library file	The library file selected in the library browser cannot be used in this system. Select a file with a CPW extension.
<b>O</b>	Out of memory	Memory is not sufficient to perform the operation. Quit other applications, re-allocate memory, and then restart the operation.
<b>S</b>	System error	An error occurs when the library file is being stored. Reserve sufficient free disk space and restart the operation.
<b>T</b>	This file was created using an old version editor and cannot be converted	The current file is a CPL file created in Parts Box. Use the file converter to convert the file into a CPW file.
<b>U</b>	Unable to convert memory block into cell	The memory is not sufficient to execute the operation. Quit other applications, re-allocate memory, and then restart the operation.
	Unable to create cell list	The library file is corrupt for some reason. Use the provided rebuilding tool to repair the file and then restart the list creation.

■ D-Script Errors

	<b>Error Message</b>	<b>Cause/Solution</b>
<b>C</b>	Constant value out of range:	The preset constant value exceeds the specified range. Enter a correct value.*
<b>D</b>	D-Script function name has not been entered. Please type the function's name in the description field.	Do not click OK without entering the function name; you must first specify the function name. Enter the function name.
<b>E</b>	Expression too complex. See HELP screens for assistance.	Simplify the D-Script expression.
<b>I</b>	if' expression requires a non-empty statement	An expression is required in { } in the if clause. If no expression is specified, the if clause is ignored.*
	Illegal Expression	The entered expression contains an error and will not be recognized.*
	Illegal syntax	The entered D-Script expression has a syntax error.
	Illegal address	The entered address setting contains an error. Enable the syntax help in the option setting menu and enter the address by clicking the icon, or enter it from the keypad.
<b>N</b>	Negative numbers not supported - select correct data type	A negative number cannot be used as a constant. Enter a positive number.*
<b>T</b>	This script expression is not legal (it will not download). Do you still want to register this data and quit the D-Script editor?	The preset D-Script expression has an error. Even if this script is registered, the operation will be not performed.
<b>W</b>	WARNING: Statement has no effect and has been removed	The entered instruction is ignored because it will not influence the expression.

\* These messages are displayed only when the syntax check in the option setting menu is selected.

### ■ Alarm Editor Errors

	<b>Error Message</b>	<b>Cause/Solution</b>
<b>C</b>	<b>Can't Add Messages - Insufficient memory</b>	Memory is not sufficient to add the messages. Quit other applications, re-allocate memory and try to add the messages again.
	<b>Can't import more basic alarm messages. Basic alarm message limit has been reached.</b>	During message import, the number of Bit Alarm Log messages has exceeded the designated limit. Delete the messages currently set and adjust the setting range so that the messages to be imported can be stored.
	<b>Can't import more log alarm messages. Log alarm message limit has been reached.</b>	During message import, the number of Bit Alarm Log messages has exceeded the designated limit. Delete the messages currently set and adjust the setting range so that the messages to be imported can be stored.
	<b>Can't import more word alarm messages. Word alarm message limit has been reached.</b>	During message import, the number of Bit Alarm Log messages has exceeded the designated limit. Delete the messages currently set and adjust the setting range so that the messages to be imported can be stored.
<b>D</b>	<b>Data in Blocks 2 and 3 cannot be uploaded to the GP.</b>	Since the "Block" feature was turned OFF when this data was downloaded, please delete Blocks 2 and 3.
<b>L</b>	<b>Low Memory - not all messages can be pasted!</b>	Memory is not sufficient to paste all the messages. Quit other applications, re-allocate memory and paste the messages again.
	<b>Low Memory - not all alarms were copied! Try copying a smaller group.</b>	Memory is not sufficient to paste all the messages. Quit other applications, re-allocate memory and paste the messages again.
<b>N</b>	<b>Not enough memory to perform undo! Do you want to continue?</b>	Memory is not sufficient to undo the messages. The deleted message(s) cannot be undone (restored)
	<b>Not all alarms were saved. Insufficient disk space</b>	Disk capacity is not enough to store the data. Create more free disk space and store the data again.
	<b>Not all alarms were read. Insufficient memory</b>	Memory is not sufficient to read the alarm messages. Quit other applications, create more memory and read in the alarms again.
<b>S</b>	<b>Some data is incorrect and all data cannot be imported.</b>	The format of CSV data to be imported is incorrect. Data in and below the line with the incorrect data will not be imported. Check Alarm data's CSV format.
<b>T</b>	<b>The block function is not supported by this model. All block settings operate according to Q tag setting. Please check Q tag settings.</b>	The setup is attempted on an incompatible model. This feature is disabled on this model GP.



■ **Symbol Editor Errors**

	<b>Error Message</b>	<b>Cause/Solution</b>
<b>A</b>	Addresses cannot be used as symbol names!	Enter a standard address in the address column.
<b>D</b>	Disk space is insufficient.	The disk in which the data is stored has no free space. Create more free space and try again.
<b>T</b>	This Symbol Name is already in use. Please choose another name.	A symbol of the same name has already been defined. Rename the symbol.
	This is not a symbol file. Please choose the correct format file.	The chosen file is not a file that can be used for symbol import. Please choose a file that is this format, or modify the chosen file so that it becomes this format.
	This is not a device comment file. Please choose the correct format file.	The chosen file is not a device comment import file. Please choose a file that is this format, or modify the chosen file so that it becomes this format.
	This symbol name is already registered as a GLC symbol. Please choose another name.	You attempted to change an existing symbol name. Designate a symbol other than one set up as GLC Discrete with the Bit Symbol and other than one set up as GLC Integer Symbol/GLC Real Symbol with the Word Symbol.
	The total number of GLC symbols is over 2048 and a Save cannot be performed. Please delete all unneeded symbols.	The maximum number of symbols has been exceeded. After deleting unneeded symbols, please retry saving the data.
<b>S</b>	Some data is incorrect and all data cannot be imported.	The format of CSV data to be imported is incorrect. Data in and below the line with the incorrect data will not be imported. Check Alarm data' CSV format.
	Symbol **** 's number of characters is over 20, and cannot be imported.	You attempted to import a symbol with a name over 20 characters long. Please reduce this name to less than 20 characters.
<b>%</b>	%s cannot be found, or cannot be performed.	The file(s) required to perform this action cannot be found. Please re-install the application software.

■ **Screen Transfer Errors**

	<b>Error Message</b>	<b>Cause/Solution</b>
<b>A</b>	A different Extended Program is present in the GP. The GP's setup cannot be performed.	This extended program can only be sent to a GP containing the same program. Please change the GP type, or install the extended task's program in the GP.
	A different Extended Program is present in the GP. Do you wish to continue?	A different type of Extended Program is present in the GP. Press OK to overwrite this program, or Cancel to stop the transfer. Selecting OK will change the GP's internal Extended Program.
	A retentive variable was not able to be replaced.	An error occurred when retaining and downloading retained variables. Be sure to check the data transfer settings and retry.
<b>C</b>	Cannot transmit data at 115.2Kbps - used a slower speed. Change Data Transfer Speed to 38400 when sending data.	This error occurs when the speed of 115.2Kbps cannot be used, or when data is sent to a GP 70 series model at this speed. Change the Data Transfer Speed setting to 38400 and re-try.

■ **Screen Transfer Errors (from previous page)**

	<b>Error Message</b>	<b>Cause/Solution</b>
<b>C</b>	CF Card data will not be sent to GP	Either the GP Multi Unit's power is turned OFF, or the CF Card is not formatted. Also, if the CF Card's amount of remaining space may be insufficient. Please delete all unneeded files and retry transfer.
	Command Parameter ERROR	Retry data transfer to the designated GP using "Auto Setup". If this message appears again, the PC has a command-related problem. Or, there may be an error in the cable or in the PC. Check both and retry data transfer. If the problem persists, the cable may be damaged. If necessary, contact your local GP distributor.
	Connected Device is not correct GP!	A device other than the GP or one that is not supported by GP-PRO/PB III is connected. Check the model of the connected device.
	Core - ID Command failed	An error has occurred during data transfer from the PC. The cable may be disconnected or the GP is OFF. Retry data transfer.
<b>D</b>	Data Transfer Port initialization error.	Initialization of the communication port has failed. Check the transfer serial port settings and transfer cable connection.
	Do you want to download the simulation protocol?	When you want to transfer the simulation protocol, click OK. Otherwise, click cancel.
<b>E</b>	ERROR, Out of Memory	The GP's internal memory is full. Delete any unnecessary screens.
	ERROR, Incomplete Transmission	Screen transfer to the GP has been aborted. Refer to the error message code.
	ERROR, No Configuration File	The file required for setup was not found in the specified folder. Re-install the system from the Master disk, or check the transfer path settings. (Transfer Settings area)
	ERROR, Cannot Transfer Data	A communication error has occurred and transfer has failed. Reset the GP and PC and retry data transfer.
	ERROR, Cannot open Screen	The system is trying to transfer the screen to the GP but cannot open the Project File.
	ERROR, Doesnot supports Hardware.	Incorrect revision information (type) was designated when selecting the GLC unit's [GP Type]. Change the [GP Type] data to the correct revision code and retry sending the data.
<b>G</b>	GP node search has failed!	An error has occurred during search for the GP. Check the PC's network settings and the network cable connection. If the problem persists, contact your network manager.
<b>H</b>	Handshaking ERROR – GP not Responding	The GP power supply is turned OFF, the data cable is unplugged, or the GP may be in OFFLINE mode. Check all these points. When the GP main unit is in OFFLINE mode, reset it to transfer mode. Also, check the serial port.
<b>I</b>	If "Send User Selected Screens" is selected, upload parameter data cannot be transferred. As a result, your PC will not receive screen data from the GP unit. To send upload parameter data, select "Send All Screens" or "Automatically Send Changed Screens".	Sending screens individually can destroy the Image Control Table, and the screens may not operate correctly on the GP. If a problem occurs, resend all the screens, or use the automatic screen update feature.
	Invalid address substituted for unknown aliases, or invalid address error	When using a symbol in the device address, use the symbol editor to enter the actual symbol addresses.

■ Screen Transfer Errors (from previous page)

	<b>Error Message</b>	<b>Cause/Solution</b>
M	<b>Memory Loader Error – Unknown Type</b>	A undefined error code has been sent from Memory Loader. Check the connection to Memory Loader. Reset Memory Loader once and then re-try data transfer.
	<b>Memory Loader Error – Memory Loader Not Ready</b>	The cable used for data transfer is not connected to Memory Loader, or Memory Loader is not in the PC reception mode. Check that the PC is connected to Memory Loader using the cable and set Memory Loader in the PC reception mode. Then, re-try data transfer.
	<b>Memory Loader Error – Card Not Found</b>	Memory Loader does not have a memory card. Insert the memory card into Memory Loader and then send the card data.
	<b>Memory Loader Error – Timeout</b>	Communication timeout occurs. Reset Memory Loader and re-try data transfer.
	<b>Memory Loader Error – Memory Overflow</b>	The transferred screen data causes an overflow of the memory capacity of Memory Loader. Delete the screen data or set the upload information transfer setting to OFF. Then, re-try data transfer.
	<b>Memory Loader Error – Check Sum Error</b>	A checksum error occurs during transfer. Check that the cable is properly connected and remove the noise source near the cable. Then, re-try data transfer.
	<b>Memory Loader Error – Bad Command</b>	The transfer command is not sent correctly. Check that the cable is properly connected and remove the noise source near the cable. Then, re-try data transfer.
	<b>Memory Loader Error – Incorrect Data Received</b>	The correct command is not received from the Memory Loader during transfer. Check that the cable is properly connected and remove any noise sources near the cable. Then, re-try data transfer.
	<b>Multiple GPs have been designated as the destination, however, the system screen data will not be sent. Is this OK?</b>	You attempted to send data to multiple GPs “Send System Screen” set to ON. When sending data to multiple GPs, the GP system settings will not be transferred. Select Yes, which means only the screen data will be transferred. To send the GP system settings, you must first match the IP address in the GP system settings with the destination GP and re-try data transfer, unit by unit.
	<b>Memory Not Initialized</b>	The GP internal memory is not initialized. Initialize the memory.

■ **Screen Transfer Errors (from previous page)**

	<b>Error Message</b>	<b>Cause/Solution</b>
N	Network Connection Failed	Connection to the specified party node is failed. Check the PC network settings and the network cable connection. If the problem still remains, contact the network manager.
	Network Data Search Please enter the IP address(using standard dot separators) & IP Port Number of the GP you are connecting to. If no address is entered, the program will search in the PC's same group for this data.	Specify the GP IP address (net ID) when searching the network again or when the GP network group is different from the PC. Specify the GP IP address to be searched in the format using a dot as the delimiter. Example) 192.168.1.101
P	PGO command failed PLD command failed	The power supply to the GP may have been turned OFF, or the cable has been un-plugged. Reset the GP and the PC and retry data transfer.
	Protocol file not found	The PLC protocol file to be sent to the GP is not found in the system's directory. Re-install the GP's system starting from the master disk.
S	Send SIO Error - Unable To Open a Com Port	The COM port cannot be used. In the transfer setting menu's serial port setting, specify the available serial port, and retry data transfer.
	Send File Error - Bad File Data	The data to be sent is not correct. The data created in the temporary file cannot be read correctly. Check that the disk has sufficient free space and it is not corrupt, and retry file transfer.
	Simulation data file cannot be found.	The CSV file is not stored in the directory as the execution file. The simulation information file may be deleted, or the file may have not been created. Set the simulation feature when transferring the screen and retry data transfer.
	Simulation data file read-in error.	The CSV file cannot be read into the system. The simulation information file may have been deleted, or the file may have not been created. Set the simulation feature when transferring the screen and retry data transfer.
T	TCP/IP error	The PC's TCP/IP setting is not correct; or, the TCP/IP data is not registered. Check that the correct TCP/IP are registered in the PC's control panel, and that all control panel setting values, including the IP address, are correct.
	The IP Address of the system screen being sent and that in the GP are not the same. To send all screens, press "Yes". ("No" to send only screen data) However, if "2-Way Driver" has been designated as the destination, sending the GP's System Setting data will not change (overwrite) the IP address.	The IP address currently being sent is different from the address designated in the GP's system settings. To change the IP address, click on "Yes", to preserve the IP address, click on "No". You can either send the screen data or select "Cancel", and then change the current project data's IP address so that it matches that of the GP's.
	The Extended Program cannot be found.	The Extended Program required for setting up the GP cannot be found. Please check the CFG file's directory. Also, you may need to change the GP's type.

■ **Screen Transfer Errors (from previous page)**

	<b>Error Message</b>	<b>Cause/Solution</b>
T	The Extended Program cannot be found in the GP. The GP's Setup cannot be performed.	Unable to locate the program's destination GP for setup. Check the GP type settings and the GP type selected. Change the GP type, if needed.
	The currently selected Device/PLC type does not support the Simulation feature.	The currently selected Device/PLC type does not support the Simulation feature. This feature cannot be used with the destination Device/PLC. Deselect this feature and re-send the data.
	This GP does not support Extended Programs. The GP's setup cannot be performed.	The destination GP does not support Extended Features. Either change the GP Type, or send data that is designed for the designated GP type.
	Timeout Error	Communication timeout has occurred. Reset the GP and re-try data transfer.
W	When selecting "Send User Selected Screens", the "Upload Information" cannot be transferred even when checked, and screen data cannot be uploaded from the GP. To perform the screen upload feature, please choose "Send All Screens" or "Automatically Send Changed Screens" and check the "Upload Information" check box.	Because the GP does not have the data required for sending the data to the PC, the PC cannot receive the screen. The screen originally may have been sent with the upload information set to "Not transfer". A screen that is not sent together with the upload information cannot be received.
	Winsock return Error	An error has been returned from Winsock. The error is in the network line. Check the PC's network settings and the network cable connection. If the problem still remains, contact your network manager.
	Write Error	An error has occurred while reading the data to GP internal memory. Re-try data transfer. If the error occurs again, use the GP's self-diagnosis feature and identify the problem. If necessary, contact your local GP distributor.

■ **File Converter Errors**

	<b>Error Message</b>	<b>Cause/Solution</b>
C	Cannot read system information	An error is recognized in the SCD file. Check that the SCD file is created by Parts Box Version 2.0.
	Conversion aborted - database space insufficient!	The disk space is not sufficient to perform data conversion. Reserve sufficient free space and retry file conversion.
	Conversion destination (convert to) folder is not designated.	The conversion destination folder where the converted file will be stored is not specified. Specify it.
	Conversion parameters are not set	The conversion parameters for the information to be converted (conversion source, conversion destination file information) are not set. Set the required information.
I	Insufficient memory	The memory required for file conversion is insufficient. Quit all other applications, then retry file conversion.
	Invalid PLC table	The PLC table file is not a GP file, is corrupt for some reason, or has been deleted. Re-install the Device/PLC type master data file from the master disk.

### ■ File Converter Errors (from previous page)

	Error Message	Cause/Solution
O	Old CPL files from DOS version PROPB must be selected directly from the library browser's file type menu	The specified CPL file has been created by the GP-PRO/PB III DOS version. Select the file from the file selection menu of the screen editor's library browser.
	Old PLC table and some functions may not work properly. Please use latest PLC table	An old version of the PLC table file is installed. Re-install the new version of the Device/PLC type file from the master disk.
P	PLC file error	The PLC table file is not the type used for GP files, is corrupt for some reason, and has been deleted. Re-install the Device/PLC type master file from the master disk.
	PLC file not found	The specified PLC table file could not be found in the directory, or it is not the type used for a GP file. Re-install the Device/PLC type master file from the master disk.

### ■ Project Compression and Execution Errors

	Error Message	Cause/Solution
D	Disk Error - File Error During Read	The file cannot be opened. The most probable cause is corruption of the file or disk failure. Solve the problem and try again to read the file.
	Disk Error - File Error During Write	The disk is write-protected. Take off the write protection. This error also occurs when the disk is defective.
U	Unable to open file '****'. Would you like to try to find it elsewhere?	A portion of the file cannot be found. To recover divided files and recreate the original project file, all the divided files are required.
	Unable to open file '****' for reading, aborting...	The file cannot be opened. The file is corrupt or the disk has a problem. After correcting the problem, re-try opening the file.

\* The file named is inserted here \*\*\*.

### ■ Rebuild Tool Errors

	Error Message	Cause/Solution
F	File version does not match	The specified file contains settings for a version which is not supported by this rebuilding tool. Re-specify a project file (PRW file) compatible with GP-PRO/PB III for Windows.
R	Rebuilding the File has Failed	Recovery of the file has failed. This file is damaged and cannot be rebuilt.
S	PRW header is destroyed	The file header information is corrupt. This file cannot be rebuilt and cannot be used.

■ **DXF File Conversion Errors**

The error messages generated during DXF file conversion are as follows:

- (xynn) <message> (line = ????)  
 x : Conversion direction (1: DXF → GP / 2: GP → DXF)  
 y : Procedure (1: Read 2: Conversion 3: Write)  
 nn : Error code  
 (line = ????) : Line No. of the DXF file causing the error

■ **DXF File Conversion Errors**

<b>Error Code</b>	<b>Error Message</b>	<b>Cause/Solution</b>
<b>01</b>	Length Over in 1 record (line, ????)	The single record length of the DXF file exceeds 256 characters. Edit the error line so that the length is less than 256 characters.
<b>02</b>	DXF Format Error (line, ????)	Non-DXF data may be included. Correct the format of the data at the error line.
<b>03</b>	HEADER SECTION Not Found	The header section of the DXF file to be read is not found. Add the header section.
<b>04</b>	\$LIMMIN Not Found	The header section of the DXF file to be read does not have a \$LIMMIN setting. Set the option DXF size to "Use \$EXTMIN, \$EXTMAX" and re-execute the program, or add the \$LIMMIN setting.
<b>05</b>	\$LIMMAX Not Found	The header section of the DXF file to be read does not have a \$LIMMAX setting. Set the option DXF size to "Use \$EXTMIN, \$EXTMAX" and re-execute the program, or add the \$LIMMAX setting.
<b>06</b>	\$EXTMIN Not Found	The header section of the DXF file to be read does not have a \$EXTMIN setting. Set the option DXF size to "Use \$LIMMIN, \$LIMMAX" and re-execute the program, or add the \$EXTMIN setting.
<b>07</b>	\$EXTMAX Not Found	The header section of the DXF file to be read does not have a \$EXTMAX setting. Set the option DXF size to "Use \$LIMMIN, \$LIMMAX" and re-execute the program, or add the \$EXTMAX setting.
<b>08</b>	EOF Not Found	The EOF record is not specified at the end of the DXF file to be read. Add the EOF record.
<b>0A</b>	ENDSEC Not Found	The ENDSEC record is not specified at the end of the DXF file to be read. Add the ENDSEC record.
<b>0B</b>	ENDTAB Not Found (line, ????)	The ENDTAB record is not specified at the end of the TABLE section of the DXF file to be read. Add the ENDTAB record.
<b>0C</b>	(W) SEQEND Not Found (line, ????)	SEQEND to be used as a pair with VERTEX following the POLYLINE entity is not specified. Add the SEQEND record to the error line.
<b>0D</b>	Insufficient Data (line, ????)	The essential data for the element of each entity is insufficient. Add the required data to the error line.

### ■ DXF File Conversion Errors(from previous page)

<b>Error Code</b>	<b>Error Message</b>	<b>Cause/Solution</b>
<b>0E</b>	<b>LTYPE Not Defined (line, ????)</b>	The line type name specified when the entity line type is individually set is not defined in the TABLE section. Add the data of the preset line name to the TABLE section.
<b>0F</b>	<b>LAYER Not Defined (line, ????)</b>	The layer name set in the entity is not defined in the TABLE section. Add the preset layer name to the TABLE section.
<b>10</b>	<b>STYLE Not Defined (line, ????)</b>	The character style name used in the entity is not defined in the TABLE section. Add the character style name to be used to the TABLE section.
<b>11</b>	<b>BLOCKS Not Defined (line, ????)</b>	The composite picture name which is referenced by the INSERT and DIMENSION entities is not defined in the BLOCK section. Add the data of the preset composite picture name to the BLOCK section.
<b>21</b>	<b>Application Error</b>	An unexpected data case is found in the intermediate file. (This does not occur normally.) The temporary file created during conversion may not have been written. Check the free disk space and disk condition and retry conversion.
<b>22</b>	<b>BLOCKS Not Found</b>	The specified composite picture is not found when converting the INSERT and DIMENSION entities. Add the preset composite picture data to the BLOCK section.
<b>23</b>	<b>(W) BLOCKS - Over Nesting Limit</b>	The reference layers of the composite picture are more than 10 layers. A compound graphic with more than 10 layers cannot be converted. Correct the graphic data so that the number of layers will be 10 or less.
<b>24</b>	<b>(W) Conversion Data is Over 16 Kbytes</b>	The output GP screen size (after conversion) exceeds 16 K bytes. The subsequent data cannot be converted.
<b>41</b>	<b>Format Error</b>	The format of the GP data is not correct. GP data which is not supported may be involved, or the screen data is corrupt. Use the Editor to save the screen again and retry conversion.
<b>42</b>	<b>(W) Check Sum Error</b>	The checksum of the GP screen read is not correct. The data may be corrupt. Use the Editor to save the screen again and retry conversion.
<b>43</b>	<b>(W) Library Screen Not Found ????</b>	The screen being called is not found in the project. Create a destination screen or delete the data which calls the screen.
<b>44</b>	<b>(W) Mark Screen Not Found ????</b>	The mark screen being called is not found in the project. Create the destination mark screen or delete the data which calls the mark.



■ DXF File Conversion Errors(from previous page)

<b>Error Code</b>	<b>Error Message</b>	<b>Cause/Solution</b>
<b>45</b>	<b>(W) Library Screen Type Error (0x????)</b>	The type of the screen used in the screen call menu is not a base, mark, trend graph, keypad, or an image screen. GP data which is not supported may be involved, or the screen data may be corrupt. Use the Editor to save the screen again and retry conversion.
<b>46</b>	<b>(W) Screens – Over Nesting Limit</b>	The screen calling layers are greater than 10. Screens with more than 10 layers cannot be converted. Correct the data so that the number of layers will be 10 screens or less.
<b>81</b>	<b>Disk Full</b>	When writing the temporary file or output file, the disk has become full. Increase the amount of free disk space for the temporary file and output file.
<b>82</b>	<b>Insufficient Memory</b>	The process is interrupted because of insufficient memory area during operation. Close all other applications and retry the operation.
<b>FF</b>	<b>User Abort</b>	The user has interrupted the operation during conversion.

■ File Management Errors

	<b>Error Message</b>	<b>Cause/Solution</b>
<b>C</b>	<b>Cannot Write File ????</b>	The data cannot be written to the specified output file name. Check the amount of free disk, or if the disk is write-protected.
<b>I</b>	<b>Input File Name Format Error</b>	The specified input file name is different from the file name created by the editor. Specify the correct file name.
	<b>Input File Not Found</b>	The specified input file is not found. Check the file name and specify the existing file.
<b>O</b>	<b>Output File Name Format Error</b>	The specified output file name cannot be recognized by the editor. Specify the correct file name.
<b>W</b>	<b>Work Directory Not Found ????</b>	The folder in which the temporary file is created is not found. Specify the existing folder using the environment variable TEMP.

## ■ Simulation Errors

	<b>Error Message</b>	<b>Cause/Solution</b>
<b>A</b>	<b>Abnormal CF card in GP Slot.</b>	Check that the CF Card is the correct type for the GP. If it is, retry.
<b>C</b>	<b>Cannot read data in project file.</b>	The screen data cannot be read from the project file. Quit other functions and re-execute.
	<b>Cannot write simulation information data. Unable to start simulation.</b>	The system cannot write the data to the simulation information file. Check that the simulation file (TAGDATA.CSV) is not used in other applications and that the directory in which EXE exists is not write-protected.
	<b>CF card in GP Slot has file [CAPTURE\CP65535.JPG] already. GP cannot generate more filename and snapshot file. Please make rearrange files in CF card.</b>	Delete the CF Card's "CAPTURE/CP65535.JPG" file, reorganize the CF Card's files, and retry.
<b>G</b>	<b>GP cannot find CF card.</b>	Check that the CF Card is securely inserted into the CF Card Slot.
	<b>GP cannot write snapshot to CF card.</b>	Check that the amount of free space on the CF Card is sufficient, and if it is, retry.
<b>N</b>	<b>Not enough memory. Please close other applications.</b>	Retry this action after closing other active applications.
<b>P</b>	<b>PLC Data File cannot be found.</b>	The PLC table file does not exist in the specified directory. The PLC table file is deleted or it is not for the GP. Select the Device/PLC type file from the master disk and reinstall the file.
<b>S</b>	<b>Simulation aborted by link down. Please restart GP hardware.</b>	A problem such as a cable disconnection, etc. has caused the PC and the GP to not be able to communicate, which has led to the halting of the Simulation. To restart the Simulation feature, first manually reset the GP (including checking the power cord), and confirming that the Data Transfer cable is securely connected to both the PC and the GP. Next, restart the Simulation.
	<b>Simulation start failed.</b>	The GP does not respond to the simulation start command. The GP may be in another mode, or data transfer may have failed. Check the communication port settings, cable connections, GP unit power supply, and then retry the simulation data transfer.
	<b>Simulation data file cannot be found.</b>	The simulation information file (TAGDATA.CSV) does not exist in the specified directory. Check (turn on) the Transfer menu [Settings] area's [Simulation] selection, then retry the Simulation.
	<b>Simulation link goes down. Do you want to abort simulation?</b>	If you wish to continue the Simulation, check that the Data Transfer cable is securely connected, and click [No]. Normally, after a brief pause the Simulation will be restored. However, timing and other problems can prevent restoration, and will cause this message to reappear. In that case, click on [No] and quit the simulation.
	<b>Snapshot incomplete.</b>	Check that the GP's Data Transfer cable is securely connected and retry.
<b>T</b>	<b>The buzzer will not stop during simulation and the GP will not display data. All the [System area] parameters (setting values) on the [Simulation] screen are the same.</b>	Is an address 32768 (8000h) or higher used? Change the current address temporarily to 32767 or lower and retry the simulation.

■ **Sound Setting Errors**

(\*\*\*\* means the User's designated file name will be inserted here.)

	<b>Error Message</b>	<b>Cause/Solution</b>
C	Cannot access **** file.	File access has failed and the file cannot be accessed.
	Cannot access the drive. Device preparation is not possible.	Failed to access the drive. Check if an error occurred in any disk during file access.
	Cannot create **** file. Write error.	File writing has failed. Please check that the disk is correctly inserted and not write protected.
	Cannot designate CF Card Output Folder. Please designate folder.	Please designate the CF Card data's output folder.
	Cannot find **** file.	The designated file cannot be found.
	Cannot load the Share.exe program.	This program is currently being used by another program. When more than one application will be using this program, be sure to install it in your software's application folder.
	Cannot open **** file.	The designated file cannot be opened.
	Cannot see sound data.	Data conversion was performed after the CF Card's designated sound file was deleted.
	Cannot set address. Invalid address.	Designated address setting will cause continuously set addresses to exceed allowed range.

### ■ Sound Setting Errors(from previous page)

	Error Message	Cause/Solution
D	Deleted Folder while creating **** file.	The folder was deleted during data write.
	Drive disk is full. Data write failed.	Failed to write data to the disk. Check the disk capacity.
E	Error in Device Address	An unrecognized device address has been specified. Please check that the address is correct.
F	**** file is locked. Access is not possible.	The file cannot be accessed. Check if the file is being used by any other application(s).
	**** file is destroyed.	The file is destroyed (unreadable). Check on the condition of the file's disk.
	**** file format error.	The file is destroyed (unreadable). Check on the condition of the file's disk.
L	Limit for sound data! /nNot all will be merged.	Registered number of sound files to be merged exceeds limit.
P	Protected **** file. Cannot be accessed.	Check if the file is read-only, or if the disk is locked.
S	Seek error occurred during **** file access.	An error has occurred during file access. Check the condition of the file's disk.
T	The currently operation exceeds the GP's internal memory limit. Paste cannot be performed.	Reduce the amount of data copied.
	This type of WAV file format is not supported. Only PCM, 11KHz, 16 bit, and Mono type data can be read.	Change the data's format to PCM, 11KHz, 16 bit, and Mono.
	This data already exists. Do you wish to overwrite?	Sound data already exists in the designated sound data save destination.
W	WAV file is too large. All data cannot be converted. Is partial conversion OK?	The file is too large and all cannot be converted to a GP file. If possible, reduce the file's size.
T	The currently operation exceeds the GP's internal memory limit. Paste cannot be performed.	The desired Paste operation's data is too large for the GP's memory. Reduce the amount of data to be copied.
	This type of WAV file format is not supported. Only PCM, 11KHz, 16 bit, and Mono type data can be read.	Change the data's format to PCM, 11KHz, 16 bit, and Mono.
	This data already exists. Do you wish to overwrite?	Sound data already exists in the designated sound data save destination.
W	WAV file is too large. All data cannot be converted. Is partial conversion OK?	The file is too large and all WAV data cannot be converted to a GP file. If possible, reduce the file's size.

### ■ Filing Data Errors

	Error Message	Cause/Solution
C	Cannot import CSV file. Data is out of range or format is incorrect.	The number of blocks or data amounts is inappropriate in the CSV file to be imported. Enter the correct value(s).
D	Data is larger than designated data range. Please check the data settings.	Data from outside the Filing Data's range is present. Check the designated data range settings and change them if necessary.
E	Exceeds folder addition limit.	Up to 64 folders can be stored in the internal memory and up to 8999 folders can be stored in the CF card. Any folder cannot be added because the number of folders will exceed the limit.

■ **Filing Data Errors (from previous page)**

	<b>Error Message</b>	<b>Cause/Solution</b>
F	File cannot be accessed and data cannot be saved. Please check the CF Card's output folder.	Check if the CF Card is write-protected. Either remove the write protection or change the destination folder.
I	Internal memory is not sufficient to save data. Please reduce the block or data settings.	The current settings will overflow the GP's memory. Please reduce either the block or data settings.
P	Please enter a Block name.	Nothing has been entered for the Filing Data's Block data. Please enter a name.
T	The currently selected data range exceeds the maximum amount allowed. Paste cannot be performed.	Please reduce either the amount of data copied or the number of blocks copied.
W	When using 32 bit data settings the maximum number of data items is 20. OK to delete items over 20?	When using 16 bit data, up to 40 items can be used; with 32 bits, maximum is 20. Be sure the data type fits your data needs.

■ **Data Transfer Function Errors**

	<b>Error Message</b>	<b>Cause/Solution</b>
C	Cannot create Index File. No file exists in CF Card folder.	The index file cannot be created since there is no CSV file within the CF Card folder's "FILE" folder.
	Control Address cannot be disabled during address operation.	The Control Address cannot be disabled during address operation.
F	File cannot be loaded.	The file has been erased or access to the file is not authorized.
P	Part of data cannot be loaded.	Delete the data outside the range or ignore the error and continue the operation.
S	Source file and destination file are the same. Data cannot be copied.	Change the destination to another file No.
	Specified condition No. exists. Cannot be registered.	Specify an unused condition No.

■ **Logging Data Errors**

	<b>Error Message</b>	<b>Cause/Solution</b>
A	Address Entry limit reached. No more addresses can be entered.	Reduce the number of device addresses used.
C	Character size is too large. Please use a different size.	Designated character is larger than GP's character matrix. Please select a smaller size.
D	Display file data size is over maximum.	Reduce the size of the designated display.
M	Maximum number of lines is 40.	Be sure the number selected is 40 or less.
P	Paste failed.	The current paste settings (range, etc.) are not the same as the paste destination. Or, the paste action may delete a column or effect another data item's settings.
	Printer file data size is over.	Reduce the size of the area/amount of data to be printed.
T	Time settings cannot exceed 24 hours. Please adjust the settings.	Change the settings so that the time value is 24 hours or less.
	The no. of times x no. of blocks should be less than or equal to 2048.	Be sure the number of times and number of blocks produces a result that is 2048 or less.

### ■ CF Card Tool Errors

	Error Message	Cause/Solution
C	Copy has failed.	Please check the disk for any problems.

### ■ 2-Way Driver Setting Errors

	Error Message	Cause/Solution
D	Data could not be created.	An error occurred while 2-Way Driver data was being created. Check the volume available of the disk being used. Also, check if the project file exists or not.
	Data could not be saved.	An error occurred while 2-Way Driver data was being saved. Check both disk memory and if the project file exists or not.

### ■ Security Settings Errors

	Error Message	Cause/Solution
S	Same Password has been set. Please change the password of level ** or level **.	The same password cannot be used on more than one level. Please change the password into either password the dialog displays.
	Specify Password Level 15 when switching to offline is Set. Please Set Password Level 15.	Set the Password for Security Level 15. Otherwise, disable [Specify Password Level 15 when switching to offline is set.]

### ■ Time Schedule Feature Errors

	Error Message	Cause/Solution
D	Day of the week is not set.	Be sure to set the day.
S	Start & End Time are Same.	Do not signify the same end time as the start time.

### ■ Import/Export Of Text Screen Errors

	Error Message	Cause/Solution
S	Screen data size over. Aboring convert.	The imported text data contains too many text strings. The maximum amount of text strings allowed is 51,200. Reduce the size of the test data to fit this limit.
T	The file will be divided, as the CSV data is more than 256 rows it is not possible to display at a time. Would you like to continue?	Attempted to export 256 or more text screens to a CSV file. To split the file and export it, click [Yes]. To export the file without splitting it, click [No].
W	Wrong screen number. Please setting 1-8999.	The range of text screen number(s) being registered to the Text Table is incorrect. Be sure the range is from 1 to 8999.
	Wrong text length. (Max 30 character) Aboring convert.	The title of the text screen to register to the Text Table is more than 30 characters. Modify this title so that it is 30 characters or less.

## A.2 Troubleshooting

This section describes how to solve problems generated when using GP-PRO/PB III.

Before you begin troubleshooting, please check the following items again. If you answer “Yes” to all the questions, start troubleshooting. If you answer “No” to any one of the questions, set the required item and then start troubleshooting.

If the error still occurs after troubleshooting, fill the details on the error in the provided trouble report sheet and contact DIGITAL.

Item	Check
Is your personal computer's OS Windows 95/ 98/ Me/ NT/ 2000/ XP	
Is the memory capacity greater than 32 Mbytes?	
Is your PC hard disk's amount of free space sufficient?	

### A.2.1 Troubleshooting List

Error	Cause/Solution
GP-PRO/PB III will not start up	<u>Are all the environment settings correct?</u>
	 Introduction Guide
	<u>Is your personal computer hard disk's free space amount sufficient?</u> Double-click on the Windows icon. Double-click on the drive in which GP-PRO/PB III has been installed. Use the [File] menu's [Property] feature to check the amount of free disk space. If the free disk space is insufficient, empty the trash box or delete unnecessary files from the hard disk.
	<u>Is the PC's RAM memory capacity sufficient?</u> Memory of 16 M byte or more is required. Click the Windows [Start] button first, and then click on the [Settings], [Control Panel], and [System] selections. Click the virtual memory button in the system property dialog box and check that "Auto Setting (recommended)" is selected. If "Manual Setting" is selected, change the setting to "Auto Setting (recommended)". Restart the PC and then restart GP-PRO/PB III.
	Some applications do not work well with GP-PRO/PB III and such an application may interfere with the startup of GP-PRO/PB III. Quit all running applications and delete them from the Startup menu ([Startup] in the Windows [Program] menu. Restart the PC and then restart GP-PRO/PB III.

Error	Cause/Solution
Cannot draw graphic data	<p><u>Is the Editor's screen open?</u> With GP-PRO/PB III, you must select the project file and open a drawing screen before you can draw any objects. Create a new a screen or open an existing one.</p>
	<p><u>Does the disk have enough free space?</u> Prepare a disk which has enough free space.</p>
	<p><u>Is the symbol editor started?</u> The screen editor and the symbol editor cannot be started at the same time. Check that the symbol editor window has been closed.</p>
Cannot save the screen file's data	<p><u>Is the file write-protected?</u> Check whether the floppy disk is write-protected using the [Property] feature.</p>
	<p><u>Does the disk you are saving to have enough free space?</u> Prepare a disk which has enough free space.</p>
Cannot communicate between the PC and the GP	<p><u>Is the proper cable being used?</u> Be sure to use the DIGITAL transfer cable (option).</p>
	<p><u>Is the GP in the "Screen Data Transfer Mode" or "Run Mode"?</u> If not, communications between the PC and the GP will not be possible. ▼ <b>Reference</b> ▲ GP User Manual</p>
	<p><u>When receiving data from the GP, does your PC's hard disk have enough space?</u> Prepare the disk so that it has enough free space.</p>
	<p><u>Is the communication port setting correct?</u> Check that the transfer cable's serial port matches the port set in [Transfer].</p>
	<p><u>Does another application use the same communication port?</u> Check whether there is competition between the GP and a modem, or other applications which require the communication port.</p>
If: the Buzzer won't stop. The GP won't display data. Data transfer fails.	The Data Transfer cable may be loose or connected to the wrong COM port. Also, the System Data area may be incorrectly accessed, or the GP may be incorrectly set up. For details, see the next page's Appendix 2.2.
The printer does not run/ hard copy is not printed correctly	<p><u>Is the OS's (Windows) printer setting correct?</u> Check the printer setting using the Control Panel's printer property.</p>
The desired Device/PLC type and GP type are not listed when creating a new project	<p><u>Did you select the required Device/PLC and GP types when installing GP-PRO/PB III? (Custom Installation)</u> When customizing the system installation, you can select the PLC and the GP types. You cannot install a Device/PLC type or a GP type if it has not been selected previously. Re-install the system with the desired PLC and GP types.</p>
Simulation cannot be performed	Possible causes are that LS area data is being backed up to the GP, via the [GP System Settings], or that an LS area Special Relay is being used via D-Script or by a W-tag start up bit. If any of these are true, the simulation cannot be performed. Deselect the [Option] menu - [Settings] - [LS Device Simulation].
The GP2000 series cannot be booted. Nothing is displayed on the screen and a buzzer intermittently sounds	The GP was not successfully set up. For details, refer to "Buzzer will not Stop/No Display on the GP/Transfer Disabled".
During Simulation buzzer won't stop. GP will not display. Simulation screen's [System Area] shows all the same values.	<p><u>Are you using address 32768 (8000h)?</u> Try changing your address to 32767 or lower and restarting the simulation.</p>



**A.2.2 Buzzer will not Stop/No Display on the GP/Transfer Disabled**

**■ Error Pattern by Symptom**

Error Pattern	Related Models	Buzzer Sound (Symptom)	GP Screen	Probable Cause	Solution (Reference)
1	All models	Pip, pip, pip, ... (Continues to beep intermittently or beeps every second.)	Blank (Black)	There is no startup program or the startup program has been corrupted. (When the GP is powered on)	Solutions 1, 3
2	All models	None	Normal Display	Transfer cable was removed. Improper COM port was used.	Solutions 2, 3
3	GP2000 Series	Pip, pip, pip, ... (Continues to beep intermittently twice every other second.)	Blank (Black)	The system for the target model has not been downloaded. (When the GP is powered on)	Solution 3
4	GP70/77R Series	None			
5	GP2000 Series	None	Error Message	System is not set up properly. The following warning message is displayed: "No system installed. Perform Screen Transfer (Force System Setup)".	Solution 3
6	All models	None	Blank/ Normal	Invalid access is made to "+9" or "+14" of the System Data Area.	Solution 4
		Buzzer sounds continuously			

Refer to Solution 1 when error pattern 1 is observed.

Similarly, Solution 2 corresponds to Error Pattern 2.

When error pattern 3, 4 or 5 is observed, try the procedure described in Solution 3. If Solution 1 or 2 does not solve the problem with error patterns 1 and 2, try Solution 3 as well.

Solution with the CF Memory Loader Tool is also available with the GP2000 series. **▼ Reference X ◆ CF Memory Loader Operation**

**◆ Solution 1**

1. Transfer from the PC

Transfer programs and screen data from the PC (GP-PRO/PBIII for Windows) to the GP while the buzzer of the GP sounds. (Be sure that your PC and the transfer cable are able to transfer programs and data to the GP.) GP-PRO/PB for Windows has been programmed to handle a variety of problems and retry data transfer repeatedly if the GP fails to respond successfully. In this case, GP-PRO/PB for Windows will try repeatedly to complete handshake mode (it may take more than a minute in some situations). After handshaking is completed, GP-PRO/PB for Windows will begin to transfer the Memory Loader program, system program, communication protocol program, expansion program and screen data.

◆ **Solution 2**

The transfer cable is improperly connected or has been removed. The improper COM port may have been selected. Confirm that the cable and port are set up properly for data transfer and try again.

◆ **Solution 3**

If error pattern 3, 4 or 5 has been observed, or Solution 1 or 2 does not solve the problem, perform a forced transfer from your PC. Perform the transfer even if the buzzer is sounding. (Confirm that the cable and PC are configured for successful transfers.)

1. Select [Setup] from the [Setup] menu on the [Screen Transfer] to display the [Transfer Settings] dialog box on the screen.
2. Select "Force System Setup" from the "Setup" field and click the [OK] button.

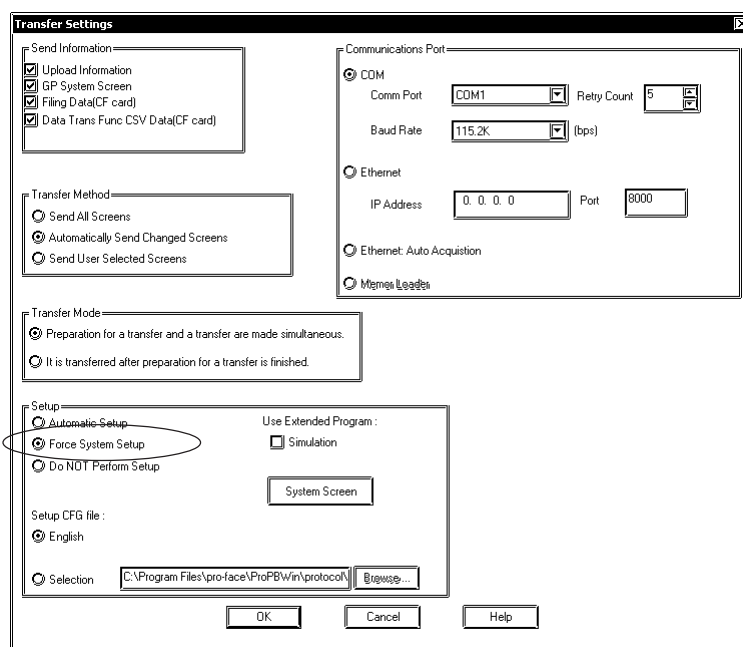

3. Select [Screen Transfer] from the [Transfer] menu and perform a forced transfer.
4. When the message "No System Program on the GP" is displayed on the screen, click the [OK] button.  
This message will not be displayed if the protocol has not been downloaded to the GP.

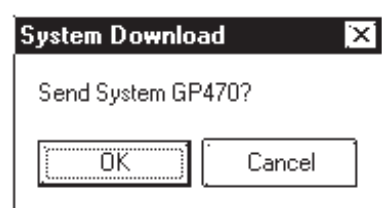

- The message "Select GP Type" is displayed on the screen. Select the model type and click the [OK] button.

Usually, the system automatically selects the connected model. However, confirm the model type of the connected GP.

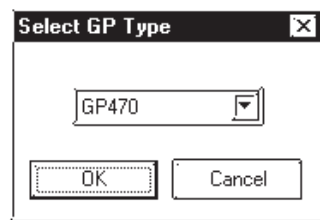

**If an improper model type is selected here before a forced transfer, the symptoms will recur.**

- Check the GP type and click the [OK] button. The system begins transferring the System Program, Protocol Program and screen data.

The restoration is completed when the transfer is completed successfully. In some cases, the "handshaking" (transfer to the GP unit) with the GP may not be successful.

If handshaking is unsuccessful, the system displays the following message on the screen to ensure successful handshaking with the GP.

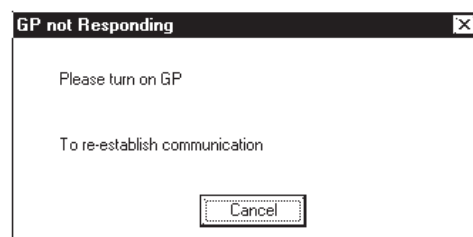

Power the GP OFF and ON again. The system will automatically resume the transfer.

#### ◆ Solution 4

Check whether an incorrect value has been entered into the GP in "+9" or "+14" of the System Data Area, or an invalid Start Address has been assigned for the System Data Area.

#### ◆ CF Memory Loader Operation (GP2000 series only)

Insert the CF Card containing the CF Memory Loader programs\* into the GP and set the DIP SW No.1 located next to the CF Card slot to ON (see figure below). Then turn ON the GP's power supply. The CF Memory Loader will then automatically start.

\*IPL. SYS, MLD\*\*\*\*. SYS, BK\*\*\*\*. MEM; where \*\*\*\* represents the model code of the target GP.

**▼ Reference** [10.6.5 Creating Backup Data](#), [10.6.7 Sending Backup Data](#)

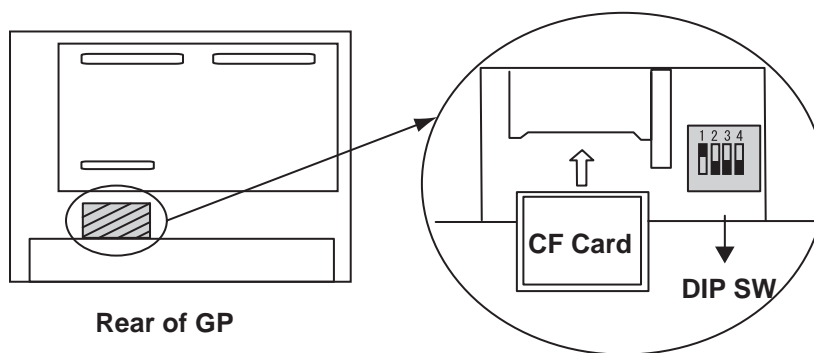

Use the CF Memory Loader Tool to download the data to the GP.

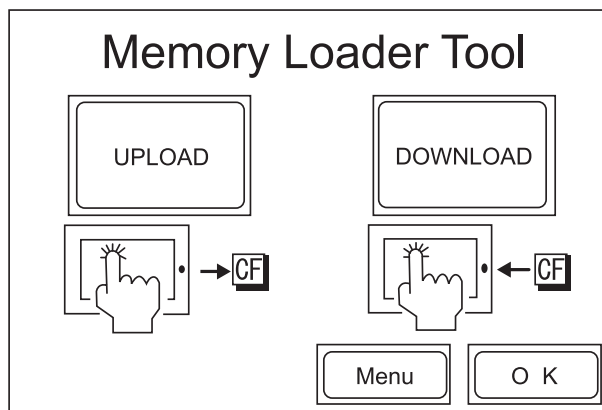

After data download is finished, remove the CF Card, set DIP SW No.1 to OFF and restart your GP.

The buzzer may sound as described below when a problem is handled with the CF Memory Loader Tool.

Error Pattern	Applicable Model	Buzzer Sound (Symptom)	Probable Cause
1	GP2000 Serie	Pip, pip, pip. ... (Continues to beep intermittently three times every other second.)	MLD****. SYS of the CF memory loader does not exist or has been corrupted. (This symptom may occur when the GP is powered on by switching on switch No.1 of the DIP SW near the CF card slot or the CF startup is performed through the 3-point pressing menu.)
2	GP2000 Serie	Pip, pip, pip, pip. ... (Continues to beep intermittently four times every other second.)	IPL. SYS of the CF memory loader exists but has been corrupted. (This symptom may occur only if the CF startup is performed through the 3-point pressing menu.)

#### ◆ Solution of Error Pattern 1

If there is no “MLD\*\*\*\*. SYS” for the target GP present in the CF Card, copy or transfer it from your PC.

If the file “MLD\*\*\*\*. SYS” is present in the CF Card and the problem still occurs, reformat the CF Card and resend both this file and “IPL. SYS” or “MLD\*\*\*\*. SYS,” to the CF Card.

#### ◆ Solution of Error Pattern 2

Reformat the CF Card and then send the necessary files, including “IPL. SYS” or “MLD\*\*\*\*. SYS” to the CF Card.

**A.3**

**Address Conversion Tables**

Addresses can or cannot be converted depending on the address combination. The combinations which cannot be converted vary with the external device manufacturers. See the following address global conversion table to convert the addresses correctly.

■ **How to Read the table**

The symbols used in the table have the following meanings:

- : When the address conversion device type is set to [Word], the system converts both Word and bit devices. When the [Bit] setting is used, only bit device addresses are changed.
- ◆ : When the selected conversion mode is [Word], only Word addresses are converted. Selecting [Bit] will convert only bit addresses.
- ★ : When [Word] mode is selected, the system converts only word addresses.
- : When [Bit] mode is selected, the system converts only bit addresses.

(Blanks cannot be converted)

For the timers and counters, the bit indicates the contact or coil used, and the word indicates the current value (elapsed value) or setting value

■ **Address Conversion Table List**

**Memory link SIO Type**

**Memory Link Ethernet Type**

**CC-Link (Remote Device Unit)**

**Device Net Slave I/O**

**Siemens Profibus**

**Siemens Interbus S**

		<b>After conversion</b>
		<b>LS</b>
<b>Before conversion</b>	<b>LS System Area</b>	○

■ Mitsubishi Electric MELSEC-A

		After Conversion											
		X	Y	M	L	F	B	TS/TC/TN	CS/CC/CN	D	W	R	LS
Before Conversion	X Input Relay	○	○	○	○	○	■	◆	◆	○	○	○	○
	Y Output Relay	○	○	○	○	○	■	◆	◆	○	○	○	○
	M Internal Relay, Special Relay	○	○	○	○	○	■	◆	◆	○	○	○	○
	L Latch Relay	○	○	○	○	○	■	◆	◆	○	○	○	○
	F Annunciator	○	○	○	○	○	■	◆	◆	○	○	○	○
	B Link Relay	■	■	■	■	■	■	■	■	■	■	■	■
	TS/TC/TN Timer	◆	◆	◆	◆	◆	■	◆	◆	◆	◆	◆	◆
	CS/CC/CN Counter	◆	◆	◆	◆	◆	■	◆	◆	◆	◆	◆	◆
	D Data/Special Register	○	○	○	○	○	■	◆	◆	○	○	○	○
	W Link Register	○	○	○	○	○	■	◆	◆	○	○	○	○
	R File Register	○	○	○	○	○	■	◆	◆	○	○	○	○
	LS System Area	○	○	○	○	○	■	◆	◆	○	○	○	○

■ Mitsubishi Electric MELSEC-N

		After Conversion											
		X	Y	M	L	F	B	TS/TC/TN	CS/CC/CN	D	W	R	LS
Before Conversion	X Input Relay	○	○	○	■	○	■	◆	◆	○	○	○	○
	Y Output Relay	○	○	○	■	○	■	◆	◆	○	○	○	○
	M Internal Relay, Special Relay	○	○	○	■	○	■	◆	◆	○	○	○	○
	L Latch Relay	■	■	■	■	■	■	■	■	■	■	■	■
	F Annunciator	○	○	○	■	○	■	◆	◆	○	○	○	○
	B Link Relay	■	■	■	■	■	■	■	■	■	■	■	■
	TS/TC/TN Timer	◆	◆	◆	◆	◆	■	◆	◆	◆	◆	◆	◆
	CS/CC/CN Counter	◆	◆	◆	◆	◆	■	◆	◆	◆	◆	◆	◆
	D Data/Special Register	○	○	○	■	○	■	◆	◆	○	○	○	○
	W Link Register	○	○	○	■	○	■	◆	◆	○	○	○	○
	R File Register	○	○	○	■	○	■	◆	◆	○	○	○	○
	LS System Area	○	○	○	■	○	■	◆	◆	○	○	○	○

■ Mitsubishi Electric MELSEC-F<sub>2</sub>

		After Conversion							
		X	Y	N	S	T/TC/TS	C/CC/CS	D	LS
Before Conversion	X Input Relay	■	■	■	■	■	■	■	■
	Y Output Relay	■	■	■	■	■	■	■	■
	M Auxiliary Relay, Keep Relay	■	■	■	■	■	■	■	■
	S State	■	■	■	■	■	■	■	■
	T/TC/TS Timer	■	■	■	■	○	○	■	■
	C/CC/CS Counter	■	■	■	■	○	○	■	■
	D Data Register	■	■	■	■	◆	◆	○	○
	LS System Area	■	■	■	■	◆	◆	○	○

■ Mitsubishi Electric MELSEC-FX

		After Conversion												
		X	Y	M	M8	S	TS	CS	TN	CN	D	D8	R	LS
Before Conversion	X Input Relay	○	○	○	○	○	■	■	★	★	○	○	○	○
	Y Output Relay	○	○	○	○	○	■	■	★	★	○	○	○	○
	M Auxiliary Relay	○	○	○	○	○	■	■	★	★	○	○	○	○
	M8 Special Auxiliary Relay	○	○	○	○	○	■	■	★	★	○	○	○	○
	S State	○	○	○	○	○	■	■	★	★	○	○	○	○
	TS Timer Contact	○	○	○	○	○	■	■			○	○	○	○
	CS Counter (contact)	○	○	○	○	○	■	■			○	○	○	○
	TN Timer (current value)	★	★	★	★	★			★	★	★	★	★	★
	CN Counter (current value)	★	★	★	★	★			★	★	★	★	★	★
	D Data Resister	○	○	○	○	○	■	■	★	★	○	○	○	○
	D8 Special Data Resister	○	○	○	○	○	■	■	★	★	○	○	○	○
	R Extend Resister	○	○	○	○	○	■	■	★	★	○	○	○	○
LS System Area	○	○	○	○	○	■	■	★	★	○	○	○	○	

■ Mitsubishi Electric MELSEC-FX2

		After Conversion									
		X	Y	M	S	TS/CS	TN/CN	D	D8	R	LS
Before Conversion	X Input Relay	○	○	○	○	■	★	○	○	○	○
	Y Output Relay	○	○	○	○	■	★	○	○	○	○
	M Internal Relay	○	○	○	○	■	★	○	○	○	○
	S Step Relay	○	○	○	○	■	★	○	○	○	○
	TS/CS Timer	■	■	■	■	■		■	■	■	■
	TN/CN Counter	★	★	★	★		★	★	★	★	★
	D Data Register	○	○	○	○	◆	★	○	○	○	○
	D8 Special Data Register	○	○	○	○	◆	★	○	○	○	○
	R Extended Register	○	○	○	○	◆	★	○	○	○	○
	LS System Area	○	○	○	○	◆	★	○	○	○	○

■ Mitsubishi Electric FREQROL Series

		After Conversion			
		-	P	All devices except for parameter	LS
Before Conversion	Parameter except for FR-S500, E500's Pr-37	○	○	○	○
	P	○	○	○	○
	Parameter for FR- S500, E500's Pr-37	○	○	○	○
	All devices except for parameter	○	○	○	○
	LS System Area	○	○	○	○



■ Mitsubishi Electric MELSEC-QnA

		After Conversion																									
		X	Y	M	SM	L	F	V	S	B	SB	TS	TC	SS	SC	CS	CC	TN	SN	CN	D	SD	W	SW	R	0R 31R	LS
Before Conversion	X Input Relay	○	○	○	○	○	○	○	○	○	■	■	■	■	■	■	★	★	★	○	○	○	○	○	○	○	○
	Y Output Relay	○	○	○	○	○	○	○	○	○	■	■	■	■	■	■	★	★	★	○	○	○	○	○	○	○	○
	M Internal Relay	○	○	○	○	○	○	○	○	○	■	■	■	■	■	■	★	★	★	○	○	○	○	○	○	○	○
	SM Special Relay	○	○	○	○	○	○	○	○	○	■	■	■	■	■	■	★	★	★	○	○	○	○	○	○	○	○
	L Latch Relay	○	○	○	○	○	○	○	○	○	■	■	■	■	■	■	★	★	★	○	○	○	○	○	○	○	○
	F Annunciator	○	○	○	○	○	○	○	○	○	■	■	■	■	■	■	★	★	★	○	○	○	○	○	○	○	○
	V Edge Relay	○	○	○	○	○	○	○	○	○	■	■	■	■	■	■	★	★	★	○	○	○	○	○	○	○	○
	S Step Relay	○	○	○	○	○	○	○	○	○	■	■	■	■	■	■	★	★	★	○	○	○	○	○	○	○	○
	B Link Relay	○	○	○	○	○	○	○	○	○	■	■	■	■	■	■	★	★	★	○	○	○	○	○	○	○	○
	SB Special Link Relay	○	○	○	○	○	○	○	○	○	■	■	■	■	■	■	★	★	★	○	○	○	○	○	○	○	○
	TS Timer (contact)	■	■	■	■	■	■	■	■	■	■	■	■	■	■	■						■	■	■	■	■	■
	TC Timer (coil)	■	■	■	■	■	■	■	■	■	■	■	■	■	■	■						■	■	■	■	■	■
	SS Aggregate Timer (contact)	■	■	■	■	■	■	■	■	■	■	■	■	■	■	■						■	■	■	■	■	■
	SC Aggregate Timer (coil)	■	■	■	■	■	■	■	■	■	■	■	■	■	■	■						■	■	■	■	■	■
	CS Counter (contact)	■	■	■	■	■	■	■	■	■	■	■	■	■	■	■						■	■	■	■	■	■
	CC Counter (coil)	■	■	■	■	■	■	■	■	■	■	■	■	■	■	■						■	■	■	■	■	■
	TN Timer (current value)	★	★	★	★	★	★	★	★	★	★							★	★	★	★	★	★	★	★	★	★
	SN Aggregate Timer (current value)	★	★	★	★	★	★	★	★	★	★							★	★	★	★	★	★	★	★	★	★
	CN Counter (current value)	★	★	★	★	★	★	★	★	★	★							★	★	★	★	★	★	★	★	★	★
	D Data Register	○	○	○	○	○	○	○	○	○	○	■	■	■	■	■	■	★	★	★	○	○	○	○	○	○	○
	SD Special Data Register	○	○	○	○	○	○	○	○	○	○	■	■	■	■	■	■	★	★	★	○	○	○	○	○	○	○
	W Link Data Register	○	○	○	○	○	○	○	○	○	○	■	■	■	■	■	■	★	★	★	○	○	○	○	○	○	○
	SW Special Link Register	○	○	○	○	○	○	○	○	○	○	■	■	■	■	■	■	★	★	★	○	○	○	○	○	○	○
	R File Register (normal)	○	○	○	○	○	○	○	○	○	○	■	■	■	■	■	■	★	★	★	○	○	○	○	○	○	○
0R - 31R File Register (serial)	○	○	○	○	○	○	○	○	○	○	■	■	■	■	■	■	★	★	★	○	○	○	○	○	○	○	
LS System Area	○	○	○	○	○	○	○	○	○	○	■	■	■	■	■	■	★	★	★	○	○	○	○	○	○	○	

■ MELSEC- Q Series (Q Mode CPU)

		After Conversion																										
		X	Y	M	SM	L	F	V	S	B	SB	TS	TC	SS	SC	CS	CC	TN	SN	CN	D	SD	W	SW	R	OR 31R	LS	
Before Conversion	X Input Relay	○	○	○	○	○	○	○	○	○	■	■	■	■	■	■	★	★	★	○	○	○	○	○	○	○	○	○
	Y Output Relay	○	○	○	○	○	○	○	○	○	■	■	■	■	■	■	★	★	★	○	○	○	○	○	○	○	○	○
	M Internal Relay	○	○	○	○	○	○	○	○	○	■	■	■	■	■	■	★	★	★	○	○	○	○	○	○	○	○	○
	SM Special Relay	○	○	○	○	○	○	○	○	○	■	■	■	■	■	■	★	★	★	○	○	○	○	○	○	○	○	○
	L Latch Relay	○	○	○	○	○	○	○	○	○	■	■	■	■	■	■	★	★	★	○	○	○	○	○	○	○	○	○
	F Annunciator	○	○	○	○	○	○	○	○	○	■	■	■	■	■	■	★	★	★	○	○	○	○	○	○	○	○	○
	V Edge Relay	○	○	○	○	○	○	○	○	○	■	■	■	■	■	■	★	★	★	○	○	○	○	○	○	○	○	○
	S Step Relay	○	○	○	○	○	○	○	○	○	■	■	■	■	■	■	★	★	★	○	○	○	○	○	○	○	○	○
	B Link Relay	○	○	○	○	○	○	○	○	○	■	■	■	■	■	■	★	★	★	○	○	○	○	○	○	○	○	○
	SB Special Link Relay	○	○	○	○	○	○	○	○	○	■	■	■	■	■	■	★	★	★	○	○	○	○	○	○	○	○	○
	TS Timer (contact)	■	■	■	■	■	■	■	■	■	■	■	■	■	■	■						■	■	■	■	■	■	■
	TC Timer (coil)	■	■	■	■	■	■	■	■	■	■	■	■	■	■	■						■	■	■	■	■	■	■
	SS Aggregate Timer (contact)	■	■	■	■	■	■	■	■	■	■	■	■	■	■	■						■	■	■	■	■	■	■
	SC Aggregate Timer (coil)	■	■	■	■	■	■	■	■	■	■	■	■	■	■	■						■	■	■	■	■	■	■
	CS Counter (contact)	■	■	■	■	■	■	■	■	■	■	■	■	■	■	■						■	■	■	■	■	■	■
	CC Counter (coil)	■	■	■	■	■	■	■	■	■	■	■	■	■	■	■						■	■	■	■	■	■	■
	TN Timer (current value)	★	★	★	★	★	★	★	★	★	★							★	★	★	★	★	★	★	★	★	★	★
	SN Aggregate Timer (current value)	★	★	★	★	★	★	★	★	★	★							★	★	★	★	★	★	★	★	★	★	★
	CN Counter (current value)	★	★	★	★	★	★	★	★	★	★							★	★	★	★	★	★	★	★	★	★	★
	D Data Register	○	○	○	○	○	○	○	○	○	○	■	■	■	■	■	■	★	★	★	○	○	○	○	○	○	○	○
	SD Special Data Register	○	○	○	○	○	○	○	○	○	○	■	■	■	■	■	■	★	★	★	○	○	○	○	○	○	○	○
	W Link Data Register	○	○	○	○	○	○	○	○	○	○	■	■	■	■	■	■	★	★	★	○	○	○	○	○	○	○	○
	SW Special Link Register	○	○	○	○	○	○	○	○	○	○	■	■	■	■	■	■	★	★	★	○	○	○	○	○	○	○	○
	R File Register (normal)	○	○	○	○	○	○	○	○	○	○	■	■	■	■	■	■	★	★	★	○	○	○	○	○	○	○	○
	0R - 31R File Register (serial)	○	○	○	○	○	○	○	○	○	○	■	■	■	■	■	■	★	★	★	○	○	○	○	○	○	○	○
	LS System Area	○	○	○	○	○	○	○	○	○	○	■	■	■	■	■	■	★	★	★	○	○	○	○	○	○	○	○

■ Mitsubishi Electric MELSEC-A/QnA/Q Series (MELSECNET/10)

		After Conversion																											
		X	Y	M	SM	L	F	B	SB	V	S	TS	TC	CS	CC	SS	SC	TN	CN	SN	D	SD	W	SW	R	LB	LW	LS	
Before Conversion	X Input Relay	○	○	○	○	○	○	○	○	○	○	○	○	○	○	○	○	○	○	○	○	○	○	○	○	○	○	○	○
	Y Output Relay	○	○	○	○	○	○	○	○	○	○	○	○	○	○	○	○	○	○	○	○	○	○	○	○	○	○	○	○
	M Internal Relay	○	○	○	○	○	○	○	○	○	○	○	○	○	○	○	○	○	○	○	○	○	○	○	○	○	○	○	○
	SM Special Relay	○	○	○	○	○	○	○	○	○	○	○	○	○	○	○	○	○	○	○	○	○	○	○	○	○	○	○	○
	L Latch Relay	○	○	○	○	○	○	○	○	○	○	○	○	○	○	○	○	○	○	○	○	○	○	○	○	○	○	○	○
	F Annunciator	○	○	○	○	○	○	○	○	○	○	○	○	○	○	○	○	○	○	○	○	○	○	○	○	○	○	○	○
	B Link Relay	○	○	○	○	○	○	○	○	○	○	○	○	○	○	○	○	○	○	○	○	○	○	○	○	○	○	○	○
	SB Special Link Relay	○	○	○	○	○	○	○	○	○	○	○	○	○	○	○	○	○	○	○	○	○	○	○	○	○	○	○	○
	V Edge Relay	○	○	○	○	○	○	○	○	○	○	○	○	○	○	○	○	○	○	○	○	○	○	○	○	○	○	○	○
	S Step Relay	○	○	○	○	○	○	○	○	○	○	○	○	○	○	○	○	○	○	○	○	○	○	○	○	○	○	○	○
	TS Timer (contact)	○	○	○	○	○	○	○	○	○	○	○	○	○	○	○	○	○	○	○	○	○	○	○	○	○	○	○	○
	TC Timer (coil)	○	○	○	○	○	○	○	○	○	○	○	○	○	○	○	○	○	○	○	○	○	○	○	○	○	○	○	○
	CS Counter (contact)	○	○	○	○	○	○	○	○	○	○	○	○	○	○	○	○	○	○	○	○	○	○	○	○	○	○	○	○
	CC Counter (coil)	○	○	○	○	○	○	○	○	○	○	○	○	○	○	○	○	○	○	○	○	○	○	○	○	○	○	○	○
	SS Aggregate Timer (contact)	○	○	○	○	○	○	○	○	○	○	○	○	○	○	○	○	○	○	○	○	○	○	○	○	○	○	○	○
	SC Aggregate Timer (coil)	○	○	○	○	○	○	○	○	○	○	○	○	○	○	○	○	○	○	○	○	○	○	○	○	○	○	○	○
	TN Timer (current value)	○	○	○	○	○	○	○	○	○	○	○	○	○	○	○	○	○	○	○	○	○	○	○	○	○	○	○	○
	CN Counter (current value)	○	○	○	○	○	○	○	○	○	○	○	○	○	○	○	○	○	○	○	○	○	○	○	○	○	○	○	○
	SN Aggregate Timer (current value)	○	○	○	○	○	○	○	○	○	○	○	○	○	○	○	○	○	○	○	○	○	○	○	○	○	○	○	○
	D Data Register	○	○	○	○	○	○	○	○	○	○	○	○	○	○	○	○	○	○	○	○	○	○	○	○	○	○	○	○
	SD Special Data Register	○	○	○	○	○	○	○	○	○	○	○	○	○	○	○	○	○	○	○	○	○	○	○	○	○	○	○	○
	W Link Data Register	○	○	○	○	○	○	○	○	○	○	○	○	○	○	○	○	○	○	○	○	○	○	○	○	○	○	○	○
	SW Special Link Register	○	○	○	○	○	○	○	○	○	○	○	○	○	○	○	○	○	○	○	○	○	○	○	○	○	○	○	○
	R File Register	○	○	○	○	○	○	○	○	○	○	○	○	○	○	○	○	○	○	○	○	○	○	○	○	○	○	○	○
	LB Internal Link Relay	○	○	○	○	○	○	○	○	○	○	○	○	○	○	○	○	○	○	○	○	○	○	○	○	○	○	○	○
	LW Internal Link Register	○	○	○	○	○	○	○	○	○	○	○	○	○	○	○	○	○	○	○	○	○	○	○	○	○	○	○	○
	LS System area	○	○	○	○	○	○	○	○	○	○	○	○	○	○	○	○	○	○	○	○	○	○	○	○	○	○	○	○

■ MELSEC-A/QnA/Q Series (CC-Link Intelligent Device Unit)

		After Conversion																										
		X	Y	M	SM	L	B	SB	TS	TC	SS	SC	CS	CC	TN	SN	CN	D	SD	W	SW	R	RX	RY	RWw	Rwr	LS	
Before Conversion	X Input Relay	○	○	○	○	○	○	○	○	○	○	○	○	○	○	○	○	○	○	○	○	○	○	○	○	○	○	○
	Y Output Relay	○	○	○	○	○	○	○	○	○	○	○	○	○	○	○	○	○	○	○	○	○	○	○	○	○	○	○
	M Internal Relay	○	○	○	○	○	○	○	○	○	○	○	○	○	○	○	○	○	○	○	○	○	○	○	○	○	○	○
	SM Special Relay	○	○	○	○	○	○	○	○	○	○	○	○	○	○	○	○	○	○	○	○	○	○	○	○	○	○	○
	L Latch Relay	○	○	○	○	○	○	○	○	○	○	○	○	○	○	○	○	○	○	○	○	○	○	○	○	○	○	○
	B Link Relay	○	○	○	○	○	○	○	○	○	○	○	○	○	○	○	○	○	○	○	○	○	○	○	○	○	○	○
	SB Special Link Relay	○	○	○	○	○	○	○	○	○	○	○	○	○	○	○	○	○	○	○	○	○	○	○	○	○	○	○
	TS Timer (contact)	○	○	○	○	○	○	○	○	○	○	○	○	○	○	○	○	○	○	○	○	○	○	○	○	○	○	○
	TC Timer (coil)	○	○	○	○	○	○	○	○	○	○	○	○	○	○	○	○	○	○	○	○	○	○	○	○	○	○	○
	SS Aggregate Timer (contact)	○	○	○	○	○	○	○	○	○	○	○	○	○	○	○	○	○	○	○	○	○	○	○	○	○	○	○
	SC Aggregate Timer (coil)	○	○	○	○	○	○	○	○	○	○	○	○	○	○	○	○	○	○	○	○	○	○	○	○	○	○	○
	CS Counter (contact)	○	○	○	○	○	○	○	○	○	○	○	○	○	○	○	○	○	○	○	○	○	○	○	○	○	○	○
	CC Counter (coil)	○	○	○	○	○	○	○	○	○	○	○	○	○	○	○	○	○	○	○	○	○	○	○	○	○	○	○
	TN Timer (current value)	○	○	○	○	○	○	○	○	○	○	○	○	○	○	○	○	○	○	○	○	○	○	○	○	○	○	○
	SN Aggregate Timer (current value)	○	○	○	○	○	○	○	○	○	○	○	○	○	○	○	○	○	○	○	○	○	○	○	○	○	○	○
	CN Counter (current value)	○	○	○	○	○	○	○	○	○	○	○	○	○	○	○	○	○	○	○	○	○	○	○	○	○	○	○
	D Data Register	○	○	○	○	○	○	○	○	○	○	○	○	○	○	○	○	○	○	○	○	○	○	○	○	○	○	○
	SD Special Data Register	○	○	○	○	○	○	○	○	○	○	○	○	○	○	○	○	○	○	○	○	○	○	○	○	○	○	○
	W Link Data Register	○	○	○	○	○	○	○	○	○	○	○	○	○	○	○	○	○	○	○	○	○	○	○	○	○	○	○
	SW Special Link Register	○	○	○	○	○	○	○	○	○	○	○	○	○	○	○	○	○	○	○	○	○	○	○	○	○	○	○
	R File Register	○	○	○	○	○	○	○	○	○	○	○	○	○	○	○	○	○	○	○	○	○	○	○	○	○	○	○
	RX Remote Input	○	○	○	○	○	○	○	○	○	○	○	○	○	○	○	○	○	○	○	○	○	○	○	○	○	○	○
	RY Remote Output	○	○	○	○	○	○	○	○	○	○	○	○	○	○	○	○	○	○	○	○	○	○	○	○	○	○	○
	RWw Remote Register	○	○	○	○	○	○	○	○	○	○	○	○	○	○	○	○	○	○	○	○	○	○	○	○	○	○	○
RWr Remote Register	○	○	○	○	○	○	○	○	○	○	○	○	○	○	○	○	○	○	○	○	○	○	○	○	○	○	○	
LS System area	○	○	○	○	○	○	○	○	○	○	○	○	○	○	○	○	○	○	○	○	○	○	○	○	○	○	○	

■ Omron SYSMAC C/α/CV

		After Conversion								
		CH	LR	AR	HR	A	TIM /T	CNT /C	D	LS
Before Conversion	CH Relay	○	○	○	○	○	◆	◆	○	○
	LR Data Link Relay	○	○	○	○	○	◆	◆	○	○
	AR Auxiliary Memory Relay	○	○	○	○	○	◆	◆	○	○
	HR Hold Relay	○	○	○	○	○	◆	◆	○	○
	A Special Auxiliary Relay	○	○	○	○	○	◆	◆	○	○
	TIM/T Timer	◆	◆	◆	◆	◆	○	○	◆	◆
	CNT/C Counter	◆	◆	◆	◆	◆	○	○	◆	◆
	D Data Memory	○	○	○	○	○	◆	◆	○	○
	LS System Area	○	○	○	○	○	◆	◆	○	○

LR (Data Link Relay), AR (Auxiliary Memory Relay) and HR (Hold Relay) are only for SYSMAC C/SYSMAC-α. A (Special Auxiliary Relay) is only for SYSMAC CV.

■ Omron SYSMAC CS1

		After Conversion														
		-	W	H	A	T (contact)	C (contact)	T (current)	C! (current)	D	E	EM	TK	IR	DR	LS
Before Conversion	Channel I/O		○	○	○	■	■	★	★	◆	○	○	○	○	○	○
	W Internal Auxiliary Relay	○	○	○	○	■	■	★	★	◆	○	○	○	○	○	○
	H Hold Relay	○	○	○	○	■	■	★	★	◆	○	○	○	○	○	○
	A Special Auxiliary Relay	○	○	○	○	■	■	★	★	◆	○	○	○	○	○	○
	T Timer (contact)	■	■	■	■	■	■				■	■	■	■	■	■
	C Counter (contact)	■	■	■	■	■	■				■	■	■	■	■	■
	T Timer (current value)	★	★	★	★			★	★	★	★	★	★	★	★	★
	C Counter (current value)	★	★	★	★			★	★	★	★	★	★	★	★	★
	D Data Memory	◆	◆	◆	◆	■	■	★	★	◆	◆	◆	◆	◆	◆	◆
	E0 ~ EC Extended Data Memory	○	○	○	○	■	■	★	★	◆	○	○	○	○	○	○
	EM Extended Data Memory	○	○	○	○	■	■	★	★	◆	○	○	○	○	○	○
	TK Task Flag	○	○	○	○	■	■	★	★	◆	○	○	○	○	○	○
	IR Index Register	○	○	○	○	■	■	★	★	◆	○	○	○	○	○	○
	DR Data Register	○	○	○	○	■	■	★	★	◆	○	○	○	○	○	○
LS System Area	○	○	○	○	■	■	★	★	◆	○	○	○	○	○	○	

■ Omron THERMAC NEO Controller

		After Conversion				
		C0	C1	C3	A	LS
Before Conversion	C0	○	○	○	○	○
	C1	○	○	○	○	○
	C3	○	○	○	○	○
	A	○	○	○	○	○
	LS	○	○	○	○	○

■ Fuji Electric MICREX-F/MICREX-F FLT-ASFk

		After Conversion										
		B/M/K/D/L	W24	F	A	TR	TS	CR	CS	BD/DI/SI	W30-W34	LS
Before Conversion	B/M/K/D/L Relay	○	○	○	○	◆	◆	◆	◆	○	○	○
	W24 Direct I/O	○	○	○	○	◆	◆	◆	◆	○	○	○
	F Special Relay	○	○	○	○	◆	◆	◆	◆	○	○	○
	A Announce Relay	○	○	○	○	◆	◆	◆	◆	○	○	○
	TR Timer (current)	◆	◆	◆	◆	○	★	○	★	◆	◆	◆
	TS Timer (setup)	◆	◆	◆	◆	★	○	★		◆	◆	◆
	CR Counter (current)	◆	◆	◆	◆	○	★	○	★	◆	◆	◆
	CS Counter (setup)	◆	◆	◆	◆	★	○	★	○	◆	◆	◆
	BD/DI/SI Data Memory	○	○	○	○	◆	◆	◆	◆	○	○	○
	W30 - W34 File Memory	○	○	○	○	◆	◆	◆	◆	○	○	○
	LS System Area	○	○	○	○	◆	◆	◆	◆	○	○	○

■ Fuji Electric MICREX-SX Series

		After Conversion					
		%IW	%QW	%MW1	%MW3	%MW10	LS
Before Conversion	Input Memory %IW	○	○	○	○	○	○
	Output Memory %QW	○	○	○	○	○	○
	Standard Memory %MW1	○	○	○	○	○	○
	Retain Memory %MW3	○	○	○	○	○	○
	System Memory %MW10	○	○	○	○	○	○
	LS	○	○	○	○	○	○

■ Fuji Electric FLEX-PC

		After Conversion									
		X	Y	M	L	T/TS	C/CS	D	W	R	LS
Before Conversion	X Input Relay	○	○	○	○	◆	◆	○	○	○	○
	Y Output Relay	○	○	○	○	◆	◆	○	○	○	○
	M Internal Relay	○	○	○	○	◆	◆	○	○	○	○
	L Latch Relay	○	○	○	○	◆	◆	○	○	○	○
	T/TS Timer	◆	◆	◆	◆	◆	◆	◆	◆	◆	◆
	C/CS Counter	◆	◆	◆	◆	◆	◆	◆	◆	◆	◆
	D Data Register	○	○	○	○	◆	◆	○	○	○	○
	W Link Register	○	○	○	○	◆	◆	○	○	○	○
	R File Register	○	○	○	○	◆	◆	○	○	○	○
	LS System Area	○	○	○	○	◆	◆	○	○	○	○

■ Fuji Electric FRENICS, FVR Series

		After Conversion									
		F	E	C	P	H	A	o	S	M	LS
Before Conversion	Fundamental Function F	○	○	○	○	○	○	○	○	○	○
	Terminal Function E	○	○	○	○	○	○	○	○	○	○
	Control Function C	○	○	○	○	○	○	○	○	○	○
	Motor 1 P	○	○	○	○	○	○	○	○	○	○
	High-level Function H	○	○	○	○	○	○	○	○	○	○
	Motor 2 A	○	○	○	○	○	○	○	○	○	○
	Option O	○	○	○	○	○	○	○	○	○	○
	Command Data S	○	○	○	○	○	○	○	○	○	○
	Monitor Data M	○	○	○	○	○	○	○	○	○	○
	System Area LS	○	○	○	○	○	○	○	○	○	○



■ Yasukawa Electric Memocon-SC

		After Conversion								
		Coil	Input Relay	Link Coil	Input Register	Output/Keep Register	Link Register	Constant Register	Ext. Register	LS System Area
Before Conversion	Coil	○	○	○	○	○	○	○	○	○
	Input Relay	○	○	○	○	○	○	○	○	○
	Link Coil	○	○	○	○	○	○	○	○	○
	Input Register	○	○	○	○	○	○	○	○	○
	Output/Keep Register	○	○	○	○	○	○	○	○	○
	Link Register	○	○	○	○	○	○	○	○	○
	Constant Register	○	○	○	○	○	○	○	○	○
	Ext. Register	○	○	○	○	○	○	○	○	○
	LS System Area	○	○	○	○	○	○	○	○	○

■ Yasukawa Electric PROGIC-8

		After Conversion											
		O	I	N	D	W	SW	DW	Z	R	SR	DR	LS
Before Conversion	O Output	○	○	○	○	○	○	○	○	○	○	○	○
	I Input	○	○	○	○	○	○	○	○	○	○	○	○
	N Current Value Register	○	○	○	○	○	○	○	○	○	○	○	○
	D Data Memory	○	○	○	○	○	○	○	○	○	○	○	○
	W Link Register	○	○	○	○	○	○	○	○	○	○	○	○
	SW System Register	○	○	○	○	○	○	○	○	○	○	○	○
	DW Register	○	○	○	○	○	○	○	○	○	○	○	○
	Z Link Relay	○	○	○	○	○	○	○	○	○	○	○	○
	R Internal Relay	○	○	○	○	○	○	○	○	○	○	○	○
	SR Stage Relay	○	○	○	○	○	○	○	○	○	○	○	○
	DR Data Register	○	○	○	○	○	○	○	○	○	○	○	○
	LS System Area	○	○	○	○	○	○	○	○	○	○	○	○

■ Yasukawa Electric GL 120/130

		After Conversion												
		O	I	D	X	Y	M	P	Q	3	4	R	7	LS
Before Conversion	O Output Relay	○	○	○	○	○	○	○	○	○	○	○	○	○
	I Input Relay	○	○	○	○	○	○	○	○	○	○	○	○	○
	D Data Memory	○	○	○	○	○	○	○	○	○	○	○	○	○
	X Input Relay	○	○	○	○	○	○	○	○	○	○	○	○	○
	Y Output Relay	○	○	○	○	○	○	○	○	○	○	○	○	○
	M Internal Relay	○	○	○	○	○	○	○	○	○	○	○	○	○
	P Relay	○	○	○	○	○	○	○	○	○	○	○	○	○
	Q Relay	○	○	○	○	○	○	○	○	○	○	○	○	○
	3	○	○	○	○	○	○	○	○	○	○	○	○	○
	4	○	○	○	○	○	○	○	○	○	○	○	○	○
	R Link Register	○	○	○	○	○	○	○	○	○	○	○	○	○
	7	○	○	○	○	○	○	○	○	○	○	○	○	○
	LS System Area	○	○	○	○	○	○	○	○	○	○	○	○	○

■ Yasukawa Electric CP-9200SH

		After Conversion				
		X	Y	M	T/C	LS
Before Conversion	GMB Output Coil	○	○	○	○	○
	GIB Input Coil	○	○	○	○	○
	GMW Hold Register	○	○	○	○	○
	GIW Input Register	○	○	○	○	○
	LS System Area	○	○	○	○	○

■ Yasukawa Electric G7/F7 Series and VS mini V7/J7 Series Variable-Speed Inverter (Varispeed)

		After Conversion		
		BR	-	LS
Before Conversion	Bit Register BR	■	■	■
	Register -	■	○	○
	LS Area LS	■	○	○

■ Yasukawa Electric MP2300/MP920 Series

		After Conversion				
		GMB	GIB	GMW	GIW	LS
Before Conversion	Coil	○	○	○	○	○
	Input Relay	○	○	○	○	○
	Keep Register	○	○	○	○	○
	Input Register	○	○	○	○	○
	LS Area	○	○	○	○	○

■ Hitachi Ltd. HIDIC S10 α

		After Conversion																							
		X	Y	R	G	E	K	T	U	C	J	Q	M	TC	TS	UC	US	CC	CS	DW	SW	EW	FW	MS	LS
Before Conversion	X Input Relay	○	○	○	○	○	○	○	○	○	○	○	○	○	○	○	○	○	○	○	○	○	○	○	○
	Y Output Relay	○	○	○	○	○	○	○	○	○	○	○	○	○	○	○	○	○	○	○	○	○	○	○	○
	R Internal Relay	○	○	○	○	○	○	○	○	○	○	○	○	○	○	○	○	○	○	○	○	○	○	○	○
	G Global Link	○	○	○	○	○	○	○	○	○	○	○	○	○	○	○	○	○	○	○	○	○	○	○	○
	E Event	○	○	○	○	○	○	○	○	○	○	○	○	○	○	○	○	○	○	○	○	○	○	○	○
	K Keep Relay	○	○	○	○	○	○	○	○	○	○	○	○	○	○	○	○	○	○	○	○	○	○	○	○
	T On-Delay Timer	○	○	○	○	○	○	○	○	○	○	○	○	○	○	○	○	○	○	○	○	○	○	○	○
	U One-shot Timer	○	○	○	○	○	○	○	○	○	○	○	○	○	○	○	○	○	○	○	○	○	○	○	○
	C Up/down Counter	○	○	○	○	○	○	○	○	○	○	○	○	○	○	○	○	○	○	○	○	○	○	○	○
	J Transfer Register	○	○	○	○	○	○	○	○	○	○	○	○	○	○	○	○	○	○	○	○	○	○	○	○
	Q Receive Register	○	○	○	○	○	○	○	○	○	○	○	○	○	○	○	○	○	○	○	○	○	○	○	○
	M Internal Hold	○	○	○	○	○	○	○	○	○	○	○	○	○	○	○	○	○	○	○	○	○	○	○	○
	TC On-delay Timer (calculated)	★	★	★	★	★	★	★	★	★	★	★	★	★	★	★	★	★	★	★	★	★	★	★	★
	TS On-delay Timer (setup)	★	★	★	★	★	★	★	★	★	★	★	★	★	★	★	★	★	★	★	★	★	★	★	★
	UC One-shot Timer (calculated)	★	★	★	★	★	★	★	★	★	★	★	★	★	★	★	★	★	★	★	★	★	★	★	★
	US One-shot Timer (setup)	★	★	★	★	★	★	★	★	★	★	★	★	★	★	★	★	★	★	★	★	★	★	★	★
	CC Up/down Counter (calculated)	★	★	★	★	★	★	★	★	★	★	★	★	★	★	★	★	★	★	★	★	★	★	★	★
	CS Up/down Counter (setup)	★	★	★	★	★	★	★	★	★	★	★	★	★	★	★	★	★	★	★	★	★	★	★	★
	DW Data Register	○	○	○	○	○	○	○	○	○	○	○	○	○	○	○	○	○	○	○	○	○	○	○	○
	SW System Register	○	○	○	○	○	○	○	○	○	○	○	○	○	○	○	○	○	○	○	○	○	○	○	○
	EW E word	○	○	○	○	○	○	○	○	○	○	○	○	○	○	○	○	○	○	○	○	○	○	○	○
	FW Work Register	○	○	○	○	○	○	○	○	○	○	○	○	○	○	○	○	○	○	○	○	○	○	○	○
	MS Extended Register	○	○	○	○	○	○	○	○	○	○	○	○	○	○	○	○	○	○	○	○	○	○	○	○
	LS System Area	○	○	○	○	○	○	○	○	○	○	○	○	○	○	○	○	○	○	○	○	○	○	○	○

■ Hitachi Ltd. S10V (Ethernet)

		After Conversion																															
		XW	YW	RW	GW	E	KW	SW	TW	UW	CW	JW	QW	MW	AW	TC	TS	UC	US	CC	CS	FW	DW	LBW	LR	LV	LW	LL	LF	LXW	LM	LG	LS
Before Conversion	External Input	○	○	○	○	○	○	○	○	○	○	○	○	○	○	★	★	★	★	★	★	○	○	○	○	○	○	○	★	○	○	★	○
	External Output	○	○	○	○	○	○	○	○	○	○	○	○	○	○	★	★	★	★	★	★	○	○	○	○	○	○	○	★	○	○	★	○
	Internal Register	○	○	○	○	○	○	○	○	○	○	○	○	○	○	★	★	★	★	★	★	○	○	○	○	○	○	○	★	○	○	★	○
	Global Link Register	○	○	○	○	○	○	○	○	○	○	○	○	○	○	★	★	★	★	★	★	○	○	○	○	○	○	○	★	○	○	★	○
	Event Register	○	○	○	○	○	○	○	○	○	○	○	○	○	○	★	★	★	★	★	★	○	○	○	○	○	○	○	★	○	○	★	○
	Keep Relay	○	○	○	○	○	○	○	○	○	○	○	○	○	○	★	★	★	★	★	★	○	○	○	○	○	○	○	★	○	○	★	○
	System Register	○	○	○	○	○	○	○	○	○	○	○	○	○	○	★	★	★	★	★	★	○	○	○	○	○	○	○	★	○	○	★	○
	On-delay Register	○	○	○	○	○	○	○	○	○	○	○	○	○	○	★	★	★	★	★	★	○	○	○	○	○	○	○	★	○	○	★	○
	One-shot Timer	○	○	○	○	○	○	○	○	○	○	○	○	○	○	★	★	★	★	★	★	○	○	○	○	○	○	○	★	○	○	★	○
	Up/Down Counter	○	○	○	○	○	○	○	○	○	○	○	○	○	○	★	★	★	★	★	★	○	○	○	○	○	○	○	★	○	○	★	○
	Transfer Resistor	○	○	○	○	○	○	○	○	○	○	○	○	○	○	★	★	★	★	★	★	○	○	○	○	○	○	○	★	○	○	★	○
	Receive Register	○	○	○	○	○	○	○	○	○	○	○	○	○	○	★	★	★	★	★	★	○	○	○	○	○	○	○	★	○	○	★	○
	Extended Internal Register	○	○	○	○	○	○	○	○	○	○	○	○	○	○	★	★	★	★	★	★	○	○	○	○	○	○	○	★	○	○	★	○
	Extended Internal Register	○	○	○	○	○	○	○	○	○	○	○	○	○	○	★	★	★	★	★	★	○	○	○	○	○	○	○	★	○	○	★	○
	Timer Calculation Value	★	★	★	★	★	★	★	★	★	★	★	★	★	★	★	★	★	★	★	★	★	★	★	★	★	★	★	★	★	★	★	★
	Timer Setting Value	★	★	★	★	★	★	★	★	★	★	★	★	★	★	★	★	★	★	★	★	★	★	★	★	★	★	★	★	★	★	★	★
	One-shot Timer Calculation Value	★	★	★	★	★	★	★	★	★	★	★	★	★	★	★	★	★	★	★	★	★	★	★	★	★	★	★	★	★	★	★	★
	One-shot Timer Setting Value	★	★	★	★	★	★	★	★	★	★	★	★	★	★	★	★	★	★	★	★	★	★	★	★	★	★	★	★	★	★	★	★
	Counter Calculation Value	★	★	★	★	★	★	★	★	★	★	★	★	★	★	★	★	★	★	★	★	★	★	★	★	★	★	★	★	★	★	★	★
	Counter Setting Value	★	★	★	★	★	★	★	★	★	★	★	★	★	★	★	★	★	★	★	★	★	★	★	★	★	★	★	★	★	★	★	★
	Work Register	○	○	○	○	○	○	○	○	○	○	○	○	○	○	★	★	★	★	★	★	○	○	○	○	○	○	○	★	○	○	★	○
	Data Register	○	○	○	○	○	○	○	○	○	○	○	○	○	○	★	★	★	★	★	★	○	○	○	○	○	○	○	★	○	○	★	○
	Work Register	○	○	○	○	○	○	○	○	○	○	○	○	○	○	★	★	★	★	★	★	○	○	○	○	○	○	○	★	○	○	★	○
	Data Converter Special Work Register	○	○	○	○	○	○	○	○	○	○	○	○	○	○	★	★	★	★	★	★	○	○	○	○	○	○	○	★	○	○	★	○
	Data Converter Special Work Register (Edge)	○	○	○	○	○	○	○	○	○	○	○	○	○	○	★	★	★	★	★	★	○	○	○	○	○	○	○	★	○	○	★	○
	Word Special Work Register	○	○	○	○	○	○	○	○	○	○	○	○	○	○	★	★	★	★	★	★	○	○	○	○	○	○	○	★	○	○	★	○
	Long Word Special Work Register	○	○	○	○	○	○	○	○	○	○	○	○	○	○	★	★	★	★	★	★	○	○	○	○	○	○	○	★	○	○	★	○
	Single Precision Floating Decimal Point Work Register	★	★	★	★	★	★	★	★	★	★	★	★	★	★	★	★	★	★	★	★	★	★	★	★	★	★	★	★	★	★	★	★
Word Work Register (Power-cut Retain)	○	○	○	○	○	○	○	○	○	○	○	○	○	○	★	★	★	★	★	★	○	○	○	○	○	○	○	★	○	○	★	○	
Long Word Work Register (Power-cut Retain)	○	○	○	○	○	○	○	○	○	○	○	○	○	○	★	★	★	★	★	★	○	○	○	○	○	○	○	★	○	○	★	○	
Single Precision Floating Decimal Point Work Register (Power-cut Retain)	★	★	★	★	★	★	★	★	★	★	★	★	★	★	★	★	★	★	★	★	★	★	★	★	★	★	★	★	★	★	★	★	
LS Area	○	○	○	○	○	○	○	○	○	○	○	○	○	○	★	★	★	★	★	★	○	○	○	○	○	○	○	★	○	○	★	○	

■ Hitachi Ltd. HIDIC H (HIZAC H)/HIDIC H2

		After Conversion								
		X	Y	R	L	M	T/C	WR	WN	LS
Before Conversion	X Input	○	○	■	○	○	◆	○	○	○
	Y Output	○	○	■	○	○	◆	○	○	○
	R Internal Output	■	■	■	■	■	■	■	■	■
	L CPU Link	○	○	■	○	○	◆	○	○	○
	M Data Area	○	○	■	○	○	◆	○	○	○
	T/C *1 Timer/Counter	◆	◆	■	◆	◆	○	★	★	◆
	WR Word Internal Output	○	○	■	○	○	★	◆	○	○
	WN Network Area	○	○	■	○	○	★	○	○	○
	LS System Area	○	○	■	○	○	◆	○	○	○

■ Hitachi Ltd. HIZAC EC

		After Conversion				
		X	Y	M	T/C	LS
Before Conversion	X External Input	○	○	○	◆	○
	Y External Output	○	○	○	◆	○
	M Internal Output	○	○	○	◆	○
	T/C Timer/Counter	◆	◆	◆	◆	◆
	LS System Area	○	○	○	◆	○

\*1: TD/SS/WDT/MS/TMR for Timers. CU/RCU/CT for counters.

**Hitachi Industrial Equipment Systems Co., Ltd.**  
**HIDIC H Series/Web Controller**

		After Conversion															
		X	Y	R	L	M	TD	SS	WDT	MS	TMR	CU	RCU	CT	TC	WR	WN
<b>Before Conversion</b>	Input	○	○	○	○	○	★	★	★	★	★	★	★	○	○	○	○
	Output	○	○	○	○	○	★	★	★	★	★	★	★	○	○	○	○
	Internal Output	○	○	○	○	○	★	★	★	★	★	★	★	○	○	○	○
	CPU Link	○	○	○	○	○	★	★	★	★	★	★	★	○	○	○	○
	Data Area	○	○	○	○	○	★	★	★	★	★	★	★	○	○	○	○
	On Delay Timer	★	★	★	★	★	★	★	★	★	★	★	★	★	★	★	★
	Signal Shot Timer	★	★	★	★	★	★	★	★	★	★	★	★	★	★	★	★
	Watchdog Timer	★	★	★	★	★	★	★	★	★	★	★	★	★	★	★	★
	Monostable Timer	★	★	★	★	★	★	★	★	★	★	★	★	★	★	★	★
	Accumulation Timer	★	★	★	★	★	★	★	★	★	★	★	★	★	★	★	★
	Up Counter	★	★	★	★	★	★	★	★	★	★	★	★	★	★	★	★
	Link Counter	★	★	★	★	★	★	★	★	★	★	★	★	★	★	★	★
	Up/Down Counter CT	★	★	★	★	★	★	★	★	★	★	★	★	★	★	★	★
	Timer/Counter (elapsed value)	○	○	○	○	○	★	★	★	★	★	★	★	○	○	○	○
	Word Internal Output	○	○	○	○	○	★	★	★	★	★	★	★	○	○	○	○
	Network Link Area	○	○	○	○	○	★	★	★	★	★	★	★	○	○	○	○
LS Area	○	○	○	○	○	★	★	★	★	★	★	★	○	○	○	○	



- **In the case of Hitachi Industrial Equipment Systems Co., Ltd. HIDIC H Series, address descriptions of bit devices (X and Y) include External Input Unit No. and Slot No..**  
**When [Address Conversion] is performed, the Unit No. and the Slot No. may also be recognized as Bit Address No. and converted. Be careful when designating addresses to be converted.**

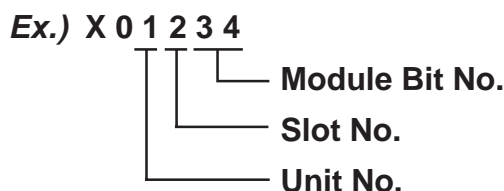

**Reference** *Device/PLC Connection Manual - Hitachi Industrial Equipment Systems Co., Ltd. - 3. Supported Devices*

**■ Hitachi Industrial Equipment Systems Co., Ltd.**  
**SJ300/L300P Series Inverters**

		After Conversion																		
		0	1	2	3	4	5	A	B	C	F	H	P	8	9	0A	0B	0E	LS	
<b>Before Conversion</b>	Normal / Reverse / Stop Command 00_	○	★	○	○	○	○	○	○	○	○	○	○	★	○	★	★	○	○	
	Frequency Value Setup 01	★	★	★	★	★	★	★	★	★	★	★	★	★	★	★	★	★	★	
	Intelligent Terminal Status Setup 02	○	★	○	○	○	○	○	○	○	○	○	○	○	★	○	★	★	○	○
	Monitor Data Batch Read 03	○	★	○	○	○	○	○	○	○	○	○	○	○	★	○	★	★	○	○
	Read Inverter Status 04	○	★	○	○	○	○	○	○	○	○	○	○	○	★	○	★	★	○	○
	Read Trip History 05	○	★	○	○	○	○	○	○	○	○	○	○	○	★	○	★	★	○	○
	Read/Setup Setting Fields A	○	★	○	○	○	○	○	○	○	○	○	○	○	★	○	★	★	○	○
	Read/Setup Setting Fields b	○	★	○	○	○	○	○	○	○	○	○	○	○	★	○	★	★	○	○
	Read/Setup Setting Fields C	○	★	○	○	○	○	○	○	○	○	○	○	○	★	○	★	★	○	○
	Read/Setup Setting Fields F	○	★	○	○	○	○	○	○	○	○	○	○	○	★	○	★	★	○	○
	Read/Setup Setting Fields H	○	★	○	○	○	○	○	○	○	○	○	○	○	★	○	★	★	○	○
	Read/Setup Setting Fields P	○	★	○	○	○	○	○	○	○	○	○	○	○	★	○	★	★	○	○
	Re-initialize Setting Values 08	★	★	★	★	★	★	★	★	★	★	★	★	★	★	★	★	★	★	★
	Check if Setting Values can be saved to EEPROM or not 09	○	★	○	○	○	○	○	○	○	○	○	○	○	★	○	★	★	○	○
	Save Setting Values to EEPROM 0A	★	★	★	★	★	★	★	★	★	★	★	★	★	★	★	★	★	★	★
	Re-calculate Internal Constant 0B	★	★	★	★	★	★	★	★	★	★	★	★	★	★	★	★	★	★	★
	Read Output Frequency Setting Value	○	★	○	○	○	○	○	○	○	○	○	○	○	★	○	★	★	○	○
LS	○	★	○	○	○	○	○	○	○	○	○	○	○	★	○	★	★	○	○	



**■ Hitachi Industrial Equipment Systems  
EH-150 Unit 1:1/1:n Device Additions**

		Before Conversion																			
		X	Y	R	L	M	TD	SS	WDT	MS	TMR	CU	RCU	CT	TC	WR	WN	TV	TM	LS	
<b>After Conversion</b>	Input X	○	○	□	○	○	□	□	□	□	□	□	□	○	○	○	□	○	○		
	Output Y	○	○	□	○	○	□	□	□	□	□	□	□	○	○	○	□	○	○		
	Internal Output R	□	□	□	□	□	□	□	□	□	□	□	□		□	□	□		□		
	CPU Link L	○	○	□	○	○	□	□	□	□	□	□	□	○	○	○	□	○	○		
	Data Area M	○	○	□	○	○	□	□	□	□	□	□	□	○	○	○	□	○	○		
	On Delay Timer TD	□	□	□	□	□	□	□	□	□	□	□	□		□	□	□		□		
	Signal Shot Timer SS	□	□	□	□	□	□	□	□	□	□	□	□		□	□	□		□		
	Watchdog Timer WDT	□	□	□	□	□	□	□	□	□	□	□	□		□	□	□		□		
	Monostable Timer MS	□	□	□	□	□	□	□	□	□	□	□	□		□	□	□		□		
	Calculation Timer TMR	□	□	□	□	□	□	□	□	□	□	□	□		□	□	□		□		
	Up Counter CU	□	□	□	□	□	□	□	□	□	□	□	□		□	□	□		□		
	Ring Counter RCU	□	□	□	□	□	□	□	□	□	□	□	□		□	□	□		□		
	Up-Down Counter CT	□	□	□	□	□	□	□	□	□	□	□	□		□	□	□		□		
	Timer Counter (Elapsed Value) TC	★	★		★	★									★	★	★		★	★	
	Word Internal Output WR	○	○	□	○	○	□	□	□	□	□	□	□	○	○	○	□	○	○		
	Network Link Area WN	○	○	□	○	○	□	□	□	□	□	□	□	○	○	○	□	○	○		
	Extended Timer TV	□	□	□	□	□	□	□	□	□	□	□	□		□	□	□		□		
	Extended Timer (Elapsed Value) TM	★	★		★	★									★	★	★		★	★	
LS	○	○	□	○	○	□	□	□	□	□	□	□	○	○	○	□	○	○			

■ Sharp New Satellite JW

		After Conversion							
		A	T (contact)	C	T (current)	B	Register	File Register	LS
Before Conversion	A Relay	○	■	■	◆	○	○	○	○
	T Timer (contact)	■	■	■		■	■	■	■
	C Counter (contact)	■	■	■		■	■	■	■
	T Timer/Counter (current)	◆			◆	◆	◆	◆	◆
	B Timer/Counter (current)	○	■	■	■	○	○	○	○
	Register	○	■	■	■	○	○	○	○
	File Register	○	■	■	■	○	○	○	○
	LS System Area	○	■	■	■	○	○	○	○

■ Matsushita Electric Works MEWNET

		After Conversion										
		X	Y	R	L	EV	SV	DT	Ld	FL	LS	R9
Before Conversion	X Input Relay	○	○	○	○	◆	◆	○	○	○	○	○
	Y Output Relay	○	○	○	○	◆	◆	○	○	○	○	○
	R Internal/Special Relay	○	○	○	○	◆	◆	○	○	○	○	○
	L Link Relay	○	○	○	○	◆	◆	○	○	○	○	○
	EV Timer/Counter (elapsed value)	◆	◆	◆	◆	○	○	◆	◆	◆	◆	◆
	SV Timer/Counter (setup)	◆	◆	◆	◆	○	○	◆	◆	◆	◆	◆
	DT Data Register	○	○	○	○	◆	◆	○	○	○	○	○
	Ld Link Register	○	○	○	○	◆	◆	○	○	○	○	○
	FL File Register	○	○	○	○	◆	◆	○	○	○	○	○
	LS System Area	○	○	○	○	◆	◆	○	○	○	○	○
	Rq Special Relay	○	○	○	○	◆	◆	○	○	○	○	○

■ Yokogawa Electric FACTORY ACE

		After Conversion																	
		X	Y	I	E	M	L	T	C	TP	CP	TS	CS	D	B	R	Z	W	LS
Before Conversion	X Input Relay	○	○	○	○	○	○	■	■	★	★	★	★	○	○	○	○	○	○
	Y Output Relay	○	○	○	○	○	○	■	■	★	★	★	★	○	○	○	○	○	○
	I Internal Relay	○	○	○	○	○	○	■	■	★	★	★	★	○	○	○	○	○	○
	E Common Relay	○	○	○	○	○	○	■	■	★	★	★	★	○	○	○	○	○	○
	M Special Relay	○	○	○	○	○	○	■	■					■	■	■	■	■	■
	L Link Relay	○	○	○	○	○	○	■	■					■	■	■	■	■	■
	T Timer (contact)	■	■	■	■	■	■	■	■	★	★	★	★	○	○	○	○	○	○
	C Counter (contact)	■	■	■	■	■	■	■	■	★	★	★	★	○	○	○	○	○	○
	TP Timer (current)	★	★	★	★	★	★			★	★	★	★	○	○	○	○	○	○
	CP Counter (current)	★	★	★	★	★	★			★	★	★	★	○	○	○	○	○	○
	TS Timer (setup)	★	★	★	★	★	★			★	★	★	★	○	○	○	○	○	○
	CS Counter (setup)	★	★	★	★	★	★			★	★	★	★	○	○	○	○	○	○
	D Data Register	○	○	○	○	○	○	■	■	★	★	★	★	○	○	○	○	○	○
	B File Register	○	○	○	○	○	○	■	■	★	★	★	★	○	○	○	○	○	○
	R Joint Register	○	○	○	○	○	○	■	■	★	★	★	★	○	○	○	○	○	○
	Z Special Register	○	○	○	○	○	○	■	■	★	★	★	★	○	○	○	○	○	○
W Link Register	○	○	○	○	○	○	■	■	★	★	★	★	○	○	○	○	○	○	
LS System Area	○	○	○	○	○	○	■	■	★	★	★	★	○	○	○	○	○	○	

R Joint Register is only for FA-M3.

■ Yokogawa Electric UT2000/Yokogawa M&C Green Series

		After Conversion		
		D	I	LS
Before Conversion	D D Register	○	○	○
	I I Relay	○	○	○
	LS System Area	○	○	○

■ Yokogawa Electric FCN/FCJ Series

		After Conversion				
		0	1	3	4	LS
Before Conversion	0	○	○	○	○	○
	1	○	○	○	○	○
	3	○	○	○	○	○
	4	○	○	○	○	○
	LS	○	○	○	○	○

■ Toyota Machine Works TOYOPUC-PC2

		After Conversion											
		X	Y	M	K	L	C	N	D	R	B	S	LS
Before Conversion	X Input Relay	○	○	○	○	○	○	★	○	○	○	○	○
	Y Output Relay	○	○	○	○	○	○	★	○	○	○	○	○
	M Internal Relay	○	○	○	○	○	○	★	○	○	○	○	○
	K Keep Relay	○	○	○	○	○	○	★	○	○	○	○	○
	L Link Relay	○	○	○	○	○	○	★	○	○	○	○	○
	V Special Relay	○	○	○	○	○	○	★	○	○	○	○	○
	N Current Value Register	★	★	★	★	★	★	○	★	★	★	★	★
	D Data Register	○	○	○	○	○	○	★	○	○	○	○	○
	R Link Register	○	○	○	○	○	○	★	○	○	○	○	○
	B File Register	○	○	○	○	○	○	★	○	○	○	○	○
	S Special Register	○	○	○	○	○	○	★	○	○	○	○	○
	LS System Area	○	○	○	○	○	○	★	○	○	○	○	○

■ Toyota Machine Works TOYOPUC-PC3 (PC3-J Series)

		After Conversion																															
		X	Y	M	K	L	V	P	T	C	D	R	S	N	B	EX	EY	EM	EK	EL	EV	EP	ET	EC	ES	EN	H	U	GX	GY	GM	LS	
Before Conversion	X Input	○	○	○	○	○	○	■	○	○	○	○	○	○	○	○	○	○	○	○	○	○	○	○	○	○	○	○	○	○	○	○	○
	Y Output	○	○	○	○	○	○	■	○	○	○	○	○	○	○	○	○	○	○	○	○	○	○	○	○	○	○	○	○	○	○	○	○
	M Internal Relay	○	○	○	○	○	○	■	○	○	○	○	○	○	○	○	○	○	○	○	○	○	○	○	○	○	○	○	○	○	○	○	○
	K Keep Relay	○	○	○	○	○	○	■	○	○	○	○	○	○	○	○	○	○	○	○	○	○	○	○	○	○	○	○	○	○	○	○	○
	L Link Relay	○	○	○	○	○	○	■	○	○	○	○	○	○	○	○	○	○	○	○	○	○	○	○	○	○	○	○	○	○	○	○	○
	V Special Relay	○	○	○	○	○	○	■	○	○	○	○	○	○	○	○	○	○	○	○	○	○	○	○	○	○	○	○	○	○	○	○	○
	P Edge Detection	■	■	■	■	■	■	■	■	■	■	■	■	■	■	■	■	■	■	■	■	■	■	■	■	■	■	■	■	■	■	■	■
	T Timer	○	○	○	○	○	○	■	○	○	○	○	○	○	○	○	○	○	○	○	○	○	○	○	○	○	○	○	○	○	○	○	○
	C Counter	○	○	○	○	○	○	■	○	○	○	○	○	○	○	○	○	○	○	○	○	○	○	○	○	○	○	○	○	○	○	○	○
	D Data Register	○	○	○	○	○	○	■	○	○	○	○	○	○	○	○	○	○	○	○	○	○	○	○	○	○	○	○	○	○	○	○	○
	R Link Register	○	○	○	○	○	○	■	○	○	○	○	○	○	○	○	○	○	○	○	○	○	○	○	○	○	○	○	○	○	○	○	○
	S Special Register	○	○	○	○	○	○	■	○	○	○	○	○	○	○	○	○	○	○	○	○	○	○	○	○	○	○	○	○	○	○	○	○
	N Current Value Register	○	○	○	○	○	○	■	○	○	○	○	○	○	○	○	○	○	○	○	○	○	○	○	○	○	○	○	○	○	○	○	○
	B File Register	○	○	○	○	○	○	■	○	○	○	○	○	○	○	○	○	○	○	○	○	○	○	○	○	○	○	○	○	○	○	○	○
	EX Extended Input	○	○	○	○	○	○	■	○	○	○	○	○	○	○	○	○	○	○	○	○	○	○	○	○	○	○	○	○	○	○	○	○
	EY Extended Output	○	○	○	○	○	○	■	○	○	○	○	○	○	○	○	○	○	○	○	○	○	○	○	○	○	○	○	○	○	○	○	○
	EM Extended Embedded Relay	○	○	○	○	○	○	■	○	○	○	○	○	○	○	○	○	○	○	○	○	○	○	○	○	○	○	○	○	○	○	○	○
	EK Extended Keep Relay	○	○	○	○	○	○	■	○	○	○	○	○	○	○	○	○	○	○	○	○	○	○	○	○	○	○	○	○	○	○	○	○
	EL Extended Link Relay	○	○	○	○	○	○	■	○	○	○	○	○	○	○	○	○	○	○	○	○	○	○	○	○	○	○	○	○	○	○	○	○
	EV Extended Special Relay	○	○	○	○	○	○	■	○	○	○	○	○	○	○	○	○	○	○	○	○	○	○	○	○	○	○	○	○	○	○	○	○
	EP Extended Edge Relay	■	■	■	■	■	■	■	■	■	■	■	■	■	■	■	■	■	■	■	■	■	■	■	■	■	■	■	■	■	■	■	■
	ET Extended Timer	○	○	○	○	○	○	■	○	○	○	○	○	○	○	○	○	○	○	○	○	○	○	○	○	○	○	○	○	○	○	○	○
	EC Extended Counter	○	○	○	○	○	○	■	○	○	○	○	○	○	○	○	○	○	○	○	○	○	○	○	○	○	○	○	○	○	○	○	○
	ES Extended Special Register	○	○	○	○	○	○	■	○	○	○	○	○	○	○	○	○	○	○	○	○	○	○	○	○	○	○	○	○	○	○	○	○
	EN Extended Current Value Register	○	○	○	○	○	○	■	○	○	○	○	○	○	○	○	○	○	○	○	○	○	○	○	○	○	○	○	○	○	○	○	○
	H(Extended Setting Value Register)	○	○	○	○	○	○	■	○	○	○	○	○	○	○	○	○	○	○	○	○	○	○	○	○	○	○	○	○	○	○	○	○
	U(Extended Data Register)	○	○	○	○	○	○	■	○	○	○	○	○	○	○	○	○	○	○	○	○	○	○	○	○	○	○	○	○	○	○	○	○
	GX Exp.2 Input	○	○	○	○	○	○	■	○	○	○	○	○	○	○	○	○	○	○	○	○	○	○	○	○	○	○	○	○	○	○	○	○
	GY Exp.2 Output	○	○	○	○	○	○	■	○	○	○	○	○	○	○	○	○	○	○	○	○	○	○	○	○	○	○	○	○	○	○	○	○
	GM Exp.2 Internal Relay	○	○	○	○	○	○	■	○	○	○	○	○	○	○	○	○	○	○	○	○	○	○	○	○	○	○	○	○	○	○	○	○
LS System Area	○	○	○	○	○	○	■	○	○	○	○	○	○	○	○	○	○	○	○	○	○	○	○	○	○	○	○	○	○	○	○	○	

■ Toshiba PROSEC EX(2000)

		After Conversion							
		X	Y	R	Z	T	C	D	LS
Before Conversion	X External Input	○	○	○	○	◆	◆	○	○
	Y External Output	○	○	○	○	◆	◆	○	○
	R Auxiliary Relay	○	○	○	○	◆	◆	○	○
	Z Link Relay	○	○	○	○	◆	◆	○	○
	T Timer	◆	◆	◆	◆	○	○	◆	◆
	C Counter	◆	◆	◆	◆	○	○	◆	◆
	D Data Register	○	○	○	○	◆	◆	○	○
	LS System Area	○	○	○	○	◆	◆	○	○

■ Toshiba PROSEC T

		After Conversion											
		X	Y	R	S	Z	L	T	C	D	W	F	LS
Before Conversion	X External Input	○	○	○	○	■	■	◆	◆	○	○	○	○
	Y External Output	○	○	○	○	■	■	◆	◆	○	○	○	○
	R Internal Relay	○	○	○	○	■	■	◆	◆	○	○	○	○
	S Special Relay	○	○	○	○	■	■	◆	◆	○	○	○	○
	Z Link Register Relay	■	■	■	■	■	■	■	■	■	■	■	■
	L Link Relay	■	■	■	■	■	■	■	■	■	■	■	■
	T Timer	◆	◆	◆	◆	■	■	○	○	◆	◆	◆	◆
	C Counter	◆	◆	◆	◆	■	■	○	○	◆	◆	◆	◆
	D Data Register	○	○	○	○	■	■	◆	◆	○	○	○	○
	W Link Register	○	○	○	○	■	■	◆	◆	○	○	○	○
	F File Register	○	○	○	○	■	■	◆	◆	○	○	○	○
	LS System Area	○	○	○	○	■	■	◆	◆	○	○	○	○

■ Toshiba PROSEC T (Ethernet)

		After Conversion												
		X	Y	R	S	Z	L	LW	T	C	D	W	F	LS
Before Conversion	X External Input	○	○	○	○	■	■	○	◆	◆	○	○	○	○
	Y External Output	○	○	○	○	■	■	○	◆	◆	○	○	○	○
	R Internal Relay	○	○	○	○	■	■	○	◆	◆	○	○	○	○
	S Special Relay	○	○	○	○	■	■	○	◆	◆	○	○	○	○
	Z Link Register Relay	■	■	■	■	■	■	■	■	■	■	■	■	■
	L Link Relay	■	■	■	■	■	■	■	■	■	■	■	■	■
	LW Link Relay	○	○	○	○	■	■	○	◆	◆	○	○	○	○
	T Timer	◆	◆	◆	◆	■	■	◆	○	○	◆	◆	◆	◆
	C Counter	◆	◆	◆	◆	■	■	◆	○	○	◆	◆	◆	◆
	D Data Register	○	○	○	○	■	■	○	◆	◆	○	○	○	○
	W Link Register	○	○	○	○	■	■	○	◆	◆	○	○	○	○
	F File Register	○	○	○	○	■	■	○	◆	◆	○	○	○	○
	LS System Area	○	○	○	○	■	■	○	◆	◆	○	○	○	○

■ **Toshiba PROVISOR B** (same as Toshiba Machine PROVISOR TC200)

		After Conversion											
		X	Y	R/G/H	A	L	S	E	T	C	P/V	D/B	LS
<b>Before Conversion</b>	X Input Relay	○	○	○	○	○	○	○	○	○	○	○	○
	Y Output Relay	○	○	○	○	○	○	○	○	○	○	○	○
	R/G/H Internal Relay	○	○	○	○	○	○	○	○	○	○	○	○
	A Special auxiliary Relay	○	○	○	○	○	○	○	○	○	○	○	○
	L Latch Relay	○	○	○	○	○	○	○	○	○	○	○	○
	S Shift Register	○	○	○	○	○	○	○	○	○	○	○	○
	E Edge Relay	○	○	○	○	○	○	○	○	○	○	○	○
	T Timer (contact)	○	○	○	○	○	○	○	○	○	○	○	○
	C Counter (contact)	○	○	○	○	○	○	○	○	○	○	○	○
	P/V Timer/counter (current/setup)	○	○	○	○	○	○	○	○	○	○	○	○
	D/B Generic Register	○	○	○	○	○	○	○	○	○	○	○	○
LS System Area	○	○	○	○	○	○	○	○	○	○	○	○	

Timers and Counters use words and bits for contacts, current values, and setup values. Conversion is performed only on the word or bit of the corresponding value. For example, when converting the current value, conversion takes place only on the current value bit and does not affect the contact or setup.



■ Toshiba TC200 Series

		After Conversion																						
		X	I	Y	O	R	G	H	J	K	A	L	S	E	T	C	P	V	D	B	U	M	Q	LS
Before Conversion	X Input Relay 1	○	○	○	○	○	○	○	○	○	○	○	○	○	○	○	○	○	○	○	○	○	○	○
	I Input Relay 2	○	○	○	○	○	○	○	○	○	○	○	○	○	○	○	○	○	○	○	○	○	○	○
	Y Output Relay 1	○	○	○	○	○	○	○	○	○	○	○	○	○	○	○	○	○	○	○	○	○	○	○
	O Output Relay 2	○	○	○	○	○	○	○	○	○	○	○	○	○	○	○	○	○	○	○	○	○	○	○
	R Internal Relay	○	○	○	○	○	○	○	○	○	○	○	○	○	○	○	○	○	○	○	○	○	○	○
	G Extended Internal Relay 1	○	○	○	○	○	○	○	○	○	○	○	○	○	○	○	○	○	○	○	○	○	○	○
	H Extended Internal Relay 2	○	○	○	○	○	○	○	○	○	○	○	○	○	○	○	○	○	○	○	○	○	○	○
	J Extended Internal Relay 3	○	○	○	○	○	○	○	○	○	○	○	○	○	○	○	○	○	○	○	○	○	○	○
	K Extended Internal Relay 4	○	○	○	○	○	○	○	○	○	○	○	○	○	○	○	○	○	○	○	○	○	○	○
	A Special Auxiliary Relay 4	○	○	○	○	○	○	○	○	○	○	○	○	○	○	○	○	○	○	○	○	○	○	○
	L Latch Relay	○	○	○	○	○	○	○	○	○	○	○	○	○	○	○	○	○	○	○	○	○	○	○
	S Shift Register	○	○	○	○	○	○	○	○	○	○	○	○	○	○	○	○	○	○	○	○	○	○	○
	E Edge Relay	○	○	○	○	○	○	○	○	○	○	○	○	○	○	○	○	○	○	○	○	○	○	○
	T Timer (contact)	○	○	○	○	○	○	○	○	○	○	○	○	○	○	○	○	○	○	○	○	○	○	○
	C Counter (contact)	○	○	○	○	○	○	○	○	○	○	○	○	○	○	○	○	○	○	○	○	○	○	○
	P Timer/Counter (current value)	○	○	○	○	○	○	○	○	○	○	○	○	○	○	○	○	○	○	○	○	○	○	○
	V Timer/Counter (setup value)	○	○	○	○	○	○	○	○	○	○	○	○	○	○	○	○	○	○	○	○	○	○	○
	D Generic Register 1	○	○	○	○	○	○	○	○	○	○	○	○	○	○	○	○	○	○	○	○	○	○	○
	B Generic Register 2	○	○	○	○	○	○	○	○	○	○	○	○	○	○	○	○	○	○	○	○	○	○	○
	U Generic Register 3	○	○	○	○	○	○	○	○	○	○	○	○	○	○	○	○	○	○	○	○	○	○	○
M Generic Register 4	○	○	○	○	○	○	○	○	○	○	○	○	○	○	○	○	○	○	○	○	○	○	○	
Q Generic Register 5	○	○	○	○	○	○	○	○	○	○	○	○	○	○	○	○	○	○	○	○	○	○	○	
LS System Area	○	○	○	○	○	○	○	○	○	○	○	○	○	○	○	○	○	○	○	○	○	○	○	

■ Koyo Electronic KOSTAC SG/SU/SZ/PZ3 Series

		After Conversion									
		I	Q	M	S	GI	SP	T	C	R	LS
Before Conversion	I Input Relay	○	○	○	○	○	○	◆	◆	○	○
	Q Output Relay	○	○	○	○	○	○	◆	◆	○	○
	M Control Relay	○	○	○	○	○	○	◆	◆	○	○
	S Stage	○	○	○	○	○	○	◆	◆	○	○
	GI Link Relay	○	○	○	○	○	○	◆	◆	○	○
	SP Specified Relay	○	○	○	○	○	○	◆	◆	○	○
	T Timer	◆	◆	◆	◆	◆	◆	○	○	◆	◆
	C Counter	◆	◆	◆	◆	◆	◆	○	○	◆	◆
	R Variable Memory Data Register	○	○	○	○	○	○	◆	◆	○	○
	LS System Area	○	○	○	○	○	○	◆	◆	○	○

■ Koyo Electronic KOSTAC SR

		After Conversion						
		(1)	(2)	(3)	(4)	(5)	(6)	(7)
Before Conversion	(1) Input/Ouput	○	○	○	○	★	○	○
	(2) Control Relay	○	○	○	○	★	○	○
	(3) Shift Register	○	○	○	○	★	○	○
	(4) Timer/Counter (contact)	○	○	○	○	★	○	○
	(5) Timer/Counter (elapsed value)	★	★	★	★	★	★	★
	(6) Data Register	○	○	○	○	★	○	○
	(7) System Area	○	○	○	○	★	○	○

■ GE Fanuc Automation Series 90-30/90-70 SNP-X

		After Conversion												
		I	Q	M	G	T	SA	SB	SC	S	R	AI	AQ	LS
Before Conversion	I Input Relay	○	○	○	○	○	○	○	○	○	○	○	○	○
	Q Output Relay	○	○	○	○	○	○	○	○	○	○	○	○	○
	M Control Relay	○	○	○	○	○	○	○	○	○	○	○	○	○
	G Global Relay	○	○	○	○	○	○	○	○	○	○	○	○	○
	T Timer Relay	○	○	○	○	○	○	○	○	○	○	○	○	○
	SA System Relay	○	○	○	○	○	○	○	○	○	○	○	○	○
	SB System Relay	○	○	○	○	○	○	○	○	○	○	○	○	○
	SC System Relay	○	○	○	○	○	○	○	○	○	○	○	○	○
	S System Relay	○	○	○	○	○	○	○	○	○	○	○	○	○
	R Register	○	○	○	○	○	○	○	○	○	○	○	○	○
	AI Analog Input	○	○	○	○	○	○	○	○	○	○	○	○	○
	AQ Analog Output	○	○	○	○	○	○	○	○	○	○	○	○	○
	LS System Area	○	○	○	○	○	○	○	○	○	○	○	○	○

■ GE Fanuc Automation Series 90-30/90-70 SNP

		After Conversion												
		I	Q	M	G	T	SA	SB	SC	S	R	AI	AQ	LS
Before Conversion	Input Relay (I)	○	○	○	○	○	○	○	○	○	○	○	○	○
	Output Relay (Q)	○	○	○	○	○	○	○	○	○	○	○	○	○
	Internal Relay (M)	○	○	○	○	○	○	○	○	○	○	○	○	○
	Global Relay (G)	○	○	○	○	○	○	○	○	○	○	○	○	○
	Temporary Relay (T)	○	○	○	○	○	○	○	○	○	○	○	○	○
	System Status Relay (SA)	○	○	○	○	○	○	○	○	○	○	○	○	○
	System Status Relay (SB)	○	○	○	○	○	○	○	○	○	○	○	○	○
	System Status Relay (SC)	○	○	○	○	○	○	○	○	○	○	○	○	○
	System Status Relay (S)	○	○	○	○	○	○	○	○	○	○	○	○	○
	Register (R)	○	○	○	○	○	○	○	○	○	○	○	○	○
	Analog Input (AI)	○	○	○	○	○	○	○	○	○	○	○	○	○
	Analog Output (AQ)	○	○	○	○	○	○	○	○	○	○	○	○	○
	LS Area (LS)	○	○	○	○	○	○	○	○	○	○	○	○	○

■ GE Fanuc Automation Series 90-30/90-70/RX7i Ethernet

		After Conversion												
		I	Q	M	G	T	SA	SB	SC	S	R	AI	AQ	W
Before Conversion	Input Relay (I)	○	○	○	○	○	○	○	○	○	○	○	○	○
	Output Relay (Q)	○	○	○	○	○	○	○	○	○	○	○	○	○
	Internal Relay (M)	○	○	○	○	○	○	○	○	○	○	○	○	○
	Global Relay (G)	○	○	○	○	○	○	○	○	○	○	○	○	○
	Momentary Relay (T)	○	○	○	○	○	○	○	○	○	○	○	○	○
	System Function Relay (SA)	○	○	○	○	○	○	○	○	○	○	○	○	○
	System Function Relay (SB)	○	○	○	○	○	○	○	○	○	○	○	○	○
	System Function Relay (SC)	○	○	○	○	○	○	○	○	○	○	○	○	○
	System Function Relay (S)	○	○	○	○	○	○	○	○	○	○	○	○	○
	Register (R)	○	○	○	○	○	○	○	○	○	○	○	○	○
	Analog Input (AI)	○	○	○	○	○	○	○	○	○	○	○	○	○
	Analog Output (AQ)	○	○	○	○	○	○	○	○	○	○	○	○	○
	Word	○	○	○	○	○	○	○	○	○	○	○	○	○

■ Fanuc FANUC Power Mate

		After Conversion							
		X	Y	R	K	T	C	D	LS
Before Conversion	<b>X</b> Input Relay	○	○	○	○	★	★	○	○
	<b>Y</b> Output Relay	○	○	○	○	★	★	○	○
	<b>R</b> Control Relay	○	○	○	○	★	★	○	○
	<b>K</b> Keep Relay	○	○	○	○	★	★	○	○
	<b>T</b> Timer	★	★	★	★	★	★	★	★
	<b>C</b> Counter	○	○	○	○	★	★	○	○
	<b>D</b> Data Table	○	○	○	○	★	★	○	○
	<b>LS</b> System Area	○	○	○	○	★	★	○	○

■ IDEC Izumi FA-2/2J/3S

		After Conversion								
		X	Y	M	R	T/TS	H	C/CS	D	LS
Before Conversion	X Input Relay	○	○	○	○	◆	◆	◆	○	○
	Y Output Relay	○	○	○	○	◆	◆	◆	○	○
	M Internal Relay	○	○	○	○	◆	◆	◆	○	○
	R Shift Register	○	○	○	○	◆	◆	◆	○	○
	T/TS Timer	◆	◆	◆	◆	◆	◆	◆	◆	◆
	H Timer (10ms)	◆	◆	◆	◆	◆	◆	◆	◆	◆
	C/CS Counter	◆	◆	◆	◆	◆	◆	◆	◆	◆
	D Data Register	○	○	○	○	◆	◆	◆	○	○
	LS System Area	○	○	○	○	◆	◆	◆	○	○

■ IDEC Izumi MICRO<sup>3</sup>

		After Conversion							
		X	Y	M	R	T/t	C/c	D	LS
Before Conversion	X Input Relay	○	○	○	○	◆	◆	○	○
	Y Output Relay	○	○	○	○	◆	◆	○	○
	M Internal Relay	○	○	○	○	◆	◆	○	○
	R Shift Register	○	○	○	○	◆	◆	○	○
	T/t Timer	◆	◆	◆	◆	◆	◆	◆	◆
	C/c Counter	◆	◆	◆	◆	◆	◆	◆	◆
	D Data Register	○	○	○	○	◆	◆	○	○
	LS System Area	○	○	○	○	◆	◆	○	○

■ FC4A Series/FC3 Series MicroSmart Open Net Controller, IDEC Izumi

Device		After Conversion															
		X	Y	M	M8	R	T (Contact)	C (Contact)	D	D8	T	t	C	c	L	Q	LS
Before Conversion	Input X	○	○	○	○	○	■	■	○	○	★	★	★	★	○	★	○
	Output Y	○	○	○	○	○	■	■	○	○	★	★	★	★	○	★	○
	Internal Relay M	○	○	○	○	○	■	■	○	○	★	★	★	★	○	★	○
	Special Internal Relay M8	○	○	○	○	○	■	■	○	○	★	★	★	★	○	★	○
	Shift Register R	○	○	○	○	○	■	■	○	○	★	★	★	★	○	★	○
	Timer (Contact) T	■	■	■	■	■	■	■	■	■					■		■
	Counter (Contact) C	■	■	■	■	■	■	■	■	■					■		■
	Data Register D	○	○	○	○	○	■	■	○	○	★	★	★	★	○	★	○
	Special Data Register D8	○	○	○	○	○	■	■	○	○	★	★	★	★	○	★	○
	Timer (setup value) T	★	★	★	★	★			★	★	★	★	★	★	★	★	★
	Timer (measured value) t	★	★	★	★	★			★	★	★	★	★	★	★	★	★
	Counter (setup value) C	★	★	★	★	★			★	★	★	★	★	★	★	★	★
	Counter (measured value) c	★	★	★	★	★			★	★	★	★	★	★	★	★	★
	Link Register L	○	○	○	○	○	■	■	○	○	★	★	★	★	○	★	○
	Timer/Counter setup value confirmation Q	★	★	★	★	★			★	★	★	★	★	★	★	★	★
LS Area LS	○	○	○	○	○	■	■	○	○	★	★	★	★	○	★	○	

■ Siemens SIMATIC

		After Conversion							
		I	O	F	T	C	D	X	LS
Before Conversion	I Input Relay	○	○	○	★	★	○	○	○
	O Output Relay	○	○	○	★	★	○	○	○
	F Control Relay	○	○	○	★	★	○	○	○
	T Timer	★	★	★	★	★	★	★	★
	C Counter	★	★	★	★	★	★	★	★
	D Data Register	○	○	○	★	★	○	○	○
	X Expanded Register	○	○	○	★	★	○	○	○
	LS System Area	○	○	○	★	★	○	○	○

There is no X (Extended Data Register) for S5 90U, 95U, 100U, 115U CPU Direct Connections.

■ Siemens SIMATIC S7 Ethernet

		After Conversion							
		E	A	M	T	Z	DB	LS	
Before Conversion	Input (E)	○	○	○	★	★	○	○	
	Output (A)	○	○	○	★	★	○	○	
	Internal Bit (M)	○	○	○	★	★	○	○	
	Timer Word (T)	★	★	★	★	★	★	★	
	Counter Word (Z)	★	★	★	★	★	★	★	
	Data Block (DB)	○	○	○	★	★	○	○	
	System Area (LS)	○	○	○	★	★	○	○	

■ Siemens S7-200 (Direct connection with PPI port)

		After Conversion							
		I	Q	M	SM	T (TW)	C (CW)	VW	LS
Before Conversion	I Input	○	○	○	○	◆	◆	○	○
	Q Output	○	○	○	○	◆	◆	○	○
	M Internal Memory	○	○	○	○	◆	◆	○	○
	SM Special Memory	○	○	○	○	◆	◆	○	○
	T (TW) Timer	◆	◆	◆	◆	◆	◆	◆	◆
	C (CW) Counter	◆	◆	◆	◆	◆	◆	◆	◆
	VW Variable Bit	○	○	○	○	◆	◆	○	○
	LS System Area	○	○	○	○	◆	◆	○	○

■ **Siemens S7-200 (Direct connection with MPI port)**

		After Conversion						
		I	Q	M	T	C	VW	LS
Before Conversion	I Input	○	○	○	◆	◆	○	○
	Q Output	○	○	○	◆	◆	○	○
	M Internal Memory	○	○	○	◆	◆	○	○
	T Timer	◆	◆	◆	◆	◆	◆	◆
	C Counter	◆	◆	◆	◆	◆	◆	◆
	VW Variable Bit	○	○	○	◆	◆	○	○
	LS System Area	○	○	○	◆	◆	○	○

■ **Siemens S7-300/400 (Direct connection with MPI port)**

		After Conversion						
		E	A	M	T	C	DB	LS
Before Conversion	E Input	○	○	○	★	★	○	○
	A Output	○	○	○	★	★	○	○
	M Internal Bit	○	○	○	★	★	○	○
	T Timer Word	★	★	★	★	★	★	★
	Z Counter Word	★	★	★	★	★	★	★
	DB Data Block	○	○	○	★	★	○	○
	LS System Area	○	○	○	★	★	○	○

■ **Siemens S7-300/400 (3964/RK512 protocol)**

		After Conversion	
		D	LS
Before Conversion	D Data Memory	○	○
	LS System Area	○	○



■ Siemens SIMATIC 505 Series

		After Conversion					
		V	X	Y	CR	All PLC Devices except for V/X/Y/CR	LS
Before Conversion	V Variable Memory	○	■	■	■	★	○
	X Discrete Input accessed as bit	■	■	■	■		■
	Y Discrete Output accessed as bit	■	■	■	■		■
	CR	■	■	■	■	★	■
	All PLC Devices except for V/X/Y/CR	★				★	★
	LS System Area	○	■	■	■	★	○

■ Schneider Electric Modbus TCP Ethernet

		After Conversion				
		0	1	4	3	LS
Before Conversion	Output Discrete 0	○	○	○	○	○
	Input Discrete 1	○	○	○	○	○
	Output Register 4	○	○	○	○	○
	Input Register 3	○	○	○	○	○
	System Area (LS)	○	○	○	○	○

■ Schneider Electric Modbus RTU 1:n

		Before Conversion				
		0	1	3	4	LS
After Conversion	0	○	○	○	○	○
	1	○	○	○	○	○
	3	○	○	○	○	○
	4	○	○	○	○	○
	LS	○	○	○	○	○

■ Schneider Electric Unitelway Modbus RTU

		Before Conversion												
		%MW	%KW	%SW	%IW	%QW	%ID	%QD	%QX	%IX	%M	%S	LS	
After Conversion	%MW	○	○	○	○	○	○	○	○	□	□	□	□	○
	%KW	○	○	○	○	○	○	○	○	□	□	□	□	○
	%SW	○	○	○	○	○	○	○	○	□	□	□	□	○
	%IW	○	○	○	○	○	○	○	○	□	□	□	□	○
	%QW	○	○	○	○	○	○	○	○	□	□	□	□	○
	%ID	○	○	○	○	○	○	○	○	□	□	□	□	○
	%QD	○	○	○	○	○	○	○	○	□	□	□	□	○
	%QX	□	□	□	□	□	□	□	□	□	□	□	□	□
	%IX	□	□	□	□	□	□	□	□	□	□	□	□	□
	%M	□	□	□	□	□	□	□	□	□	□	□	□	□
	%S	□	□	□	□	□	□	□	□	□	□	□	□	□
	LS	○	○	○	○	○	○	○	○	□	□	□	□	○

■ Rockwell (Allen Bradley) SLC 500

		After Conversion													
		O	I	B	T	T	C	C	C	N	F	ST	L	A	LS
Before Conversion	O Output	○	○	○	○	★	■	★	■	○	○	○	○	○	○
	I Input	○	○	○	○	★	■	★	■	○	○	○	○	○	○
	B Bit	○	○	○	○	★	■	★	■	○	○	○	○	○	○
	TT/DN Timer (contact)	■	■	■	■		■		■	■	■	■	■	■	■
	PRE/ACC Timer (setup/current)	★	★	★		★		★		★	★	★	★	★	★
	CU/CD/DN Counter (contact)	■	■	■	■		■		■	■	■	■	■	■	■
	PRE/ACC Counter (setup/current)	★	★	★		★		★		★	★	★	★	★	★
	Control	■	■	■	■		■		■	■	■	■	■	■	■
	N Integer	○	○	○	○	★	■	★	■	○	○	○	○	○	○
	F Floating-point	○	○	○	○	★	■	★	■	○	○	○	○	○	○
	ST String	○	○	○	○	★	■	★	■	○	○	○	○	○	○
	L Long Word	○	○	○	○	★	■	★	■	○	○	○	○	○	○
	A ASCII	○	○	○	○	★	■	★	■	○	○	○	○	○	○
LS System Area	○	○	○	○	★	■	★	■	○	○	○	○	○	○	

■ Rockwell (Allen-Bradley) SLC500 (Ethernet connection)

		After Conversion									
		B	T (TT/DN/ /EN)	C (CU/CD/ DN/OV/ UN/UA)	R (DN/EN/ ER/UK/ IN/FD/ EU/EM)	T (PRE/ ACC)	C (PRE/ ACC)	R (LEN/ POS)	N	F	LS
Before Conversion	B Bit	○	■	■	■	★	★	★	○	★	○
	TT/DN/EN Timer	■	■	■	■				■		■
	CU/CD/DN/OV/UN/UA Counter	■	■	■	■				■		■
	DN/EN/ER/UK/ IN/FD/EU/EM Control	■	■	■	■				■		■
	PRE/ACC Timer (Setup/current)	★				★	★	★	★	★	★
	PRE/ACC Counter (Setup/current)	★				★	★	★	★	★	★
	LEN/POS Control	★				★	★	★	★	★	★
	N Integer	○	■	■	■	★	★	★	○	★	○
	F Floating-point	★				★	★	★	★	★	★
	LS System Area	○	■	■	■	★	★	★	○	★	○

■ Rockwell (Allen Bradley) PLC-5

		After Conversion								
		I	O	B	TT/TD	CC/CD	TATP	CA/CP	N/D/A	LS
Before Conversion	I Input Relay	○	○	○	■	■	★	★	○	○
	O Output Relay	○	○	○	■	■	★	★	○	○
	B Internal Relay	○	○	○	■	■	★	★	○	○
	TT/TD Timer (contact)	■	■	■	■	■			■	■
	CC/CD Counter (contact)	■	■	■	■	■			■	■
	TATP Timer	★	★	★			★	★	★	★
	CA/CP Counter	★	★	★			★	★	★	★
	N/D/A Data Register	○	○	○	■	■	★	★	○	○
	LS System Area	○	○	○	■	■	★	★	○	○

**■ Rockwell (Allen Bradley) Control Logix 5000 Series**  
**Control Logix 5000 Series**  
**(Ethernet Connection)**  
**Compact Logix Ethernet**  
**(Ethernet Connection)**  
**Compact Logix 5000 Series**

		After Conversion					
		BOOL	SINT	INT	DINT	REAL	LS
<b>Before Conversion</b>	Bit (BOOL)	○	○	○	○		○
	8 bit integer (SINT)	○	○	○	○	★	○
	16 bit integer (INT)	○	○	○	○	★	○
	32 bit integer (DINT)	○	○	○	○	★	○
	32 bit integer (REAL)		★	★	★	★	★
	LS Area LS	○	○	○	○	★	○

**■ Keyence KZ-300, KZ-500 (Direct Connection)**

		After Conversion					
		Relay	T	C	DM	TM	LS
<b>Before Conversion</b>	Relay	○	◆	◆	○	○	○
	T Timer	◆	◆	◆	◆	◆	◆
	C Counter	◆	◆	◆	◆	◆	◆
	DM Data memory	○	◆	◆	○	○	○
	TM Temporary data memory	○	◆	◆	○	○	○
	LS System Area	○	◆	◆	○	○	○

■ Facom FB 20MC

		After Conversion																					
		1	2	3	4	5	6	7	8	9	10	11	12	13	14	15	16	17	18	19	20	21	22
Before Conversion	(1) X	■	■	■	■	■	■	■								■	■	■	■	■	■	■	■
	(2) Y	■	■	■	■	■	■	■								■	■	■	■	■	■	■	■
	(3) M	■	■	■	■	■	■	■								■	■	■	■	■	■	■	■
	(4) SM	■	■	■	■	■	■	■								■	■	■	■	■	■	■	■
	(5) S	■	■	■	■	■	■	■								■	■	■	■	■	■	■	■
	(6) T	■	■	■	■	■	■	■								■	■	■	■	■	■	■	■
	(7) C	■	■	■	■	■	■	■								■	■	■	■	■	■	■	■
	(8) WX								★	★	★	★	★	★	★	★	★	★	★	★	★	★	★
	(9) WY								★	★	★	★	★	★	★	★	★	★	★	★	★	★	★
	(10) WM								★	★	★	★	★	★	★	★	★	★	★	★	★	★	★
	(11) WSM								★	★	★	★	★	★	★	★	★	★	★	★	★	★	★
	(12) WS								★	★	★	★	★	★	★	★	★	★	★	★	★	★	★
	(13) TMR								★	★	★	★	★	★	★	★	★	★	★	★	★	★	★
	(14) CTR								★	★	★	★	★	★	★	★	★	★	★	★	★	★	★
	(15) HR	■	■	■	■	■	■	■	★	★	★	★	★	★	★	★	○	○	○	○	○	○	○
	(16) IR	■	■	■	■	■	■	■	★	★	★	★	★	★	★	★	○	○	○	○	○	○	○
	(17) OR	■	■	■	■	■	■	■	★	★	★	★	★	★	★	★	○	○	○	○	○	○	○
	(18) HSC	■	■	■	■	■	■	■	★	★	★	★	★	★	★	★	○	○	○	○	○	○	○
	(19) RTC	■	■	■	■	■	■	■	★	★	★	★	★	★	★	★	○	○	○	○	○	○	○
	(20) SR	■	■	■	■	■	■	■	★	★	★	★	★	★	★	★	○	○	○	○	○	○	○
	(21) ROR	■	■	■	■	■	■	■	★	★	★	★	★	★	★	★	○	○	○	○	○	○	○
	(22) LS	■	■	■	■	■	■	■	★	★	★	★	★	★	★	★	○	○	○	○	○	○	○

■ FATEK FACON Device Addition

		After Conversion																							
		X	WX	Y	WY	S	WS	M	WM	T	C	TM	CT	HC	HR	R	D	WS	IR	OR	HS	RT	SR	RO	LS
Before Conversion	X Input Relay	■		■		■		■		■	■				■	■	■	■	■	■	■	■	■	■	
	WX Input Relay		★		★		★		★			★	★	★	★	★	★	★	★	★	★	★	★	★	
	Y Output Relay	■		■		■		■		■	■				■	■	■	■	■	■	■	■	■	■	
	WY Output Relay		★		★		★		★			★	★	★	★	★	★	★	★	★	★	★	★	★	
	S S Relay	■		■		■		■		■	■				■	■	■	■	■	■	■	■	■	■	
	WS S Relay		★		★		★		★			★	★	★	★	★	★	★	★	★	★	★	★	★	
	M Auxiliary Relay	■		■		■		■		■	■				■	■	■	■	■	■	■	■	■	■	
	WM Auxiliary Relay		★		★		★		★			★	★	★	★	★	★	★	★	★	★	★	★	★	
	T Timer (contact)	■		■		■		■		■	■				■	■	■	■	■	■	■	■	■	■	
	WM Counter Contact	■		■		■		■		■	■				■	■	■	■	■	■	■	■	■	■	
	TMR Timer (current)		★		★		★		★			★	★	★	★	★	★	★	★	★	★	★	★	★	
	CTR Counter (current)		★		★		★		★			★	★	★	★	★	★	★	★	★	★	★	★	★	
	HC Hi Speed Counter		★		★		★		★			★	★	★	★	★	★	★	★	★	★	★	★	★	
	HR Data Register	■	★	■	★	■	★	■	★	■	■	★	★	★	○	○	○	○	○	○	○	○	○	○	
	R Data Register	■	★	■	★	■	★	■	★	■	■	★	★	★	○	○	○	○	○	○	○	○	○	○	
	D Data Register	■	★	■	★	■	★	■	★	■	■	★	★	★	○	○	○	○	○	○	○	○	○	○	
	WSM Special Relay	■	★	■	★	■	★	■	★	■	■	★	★	★	○	○	○	○	○	○	○	○	○	○	
	IR Input Register	■	★	■	★	■	★	■	★	■	■	★	★	★	○	○	○	○	○	○	○	○	○	○	
	OR Output Register	■	★	■	★	■	★	■	★	■	■	★	★	★	○	○	○	○	○	○	○	○	○	○	
	HSC HSC Register	■	★	■	★	■	★	■	★	■	■	★	★	★	○	○	○	○	○	○	○	○	○	○	
RTC Calendar Register	■	★	■	★	■	★	■	★	■	■	★	★	★	○	○	○	○	○	○	○	○	○	○		
SR Special Register	■	★	■	★	■	★	■	★	■	■	★	★	★	○	○	○	○	○	○	○	○	○	○		
ROR Read Only Register	■	★	■	★	■	★	■	★	■	■	★	★	★	○	○	○	○	○	○	○	○	○	○		
LS	■	★	■	★	■	★	■	★	■	■	★	★	★	○	○	○	○	○	○	○	○	○	○		

■ Modicon Modbus (Master, Slave, Plus)

		After Conversion					
		—	0	1	4	3	LS
Before Conversion	Output Bit	○	○	○	○	○	○
	Input Bit	○	○	○	○	○	○
	Output Register	○	○	○	○	○	○
	Input Register	○	○	○	○	○	○
	LS	○	○	○	○	○	○

■ Fuji Electronic Corporation PXR Series

Device		After Conversion					
		0	1	30	40	31	41
Before Conversion	0	□	□	□	□	□	□
	1	□	○	○	○	○	○
	30	□	○	○	○	○	○
	40	□	○	○	○	○	○
	31	□	○	○	○	○	○
	41	□	○	○	○	○	○
	LS Area LS	□	○	○	○	○	○

■ TOHO Electronics - TTM Series

Device		After Conversion																	
		00_	10_	100_	110_	120_	300_	1020_	SSV	END	STI	SOK	SWZ	SWT	SON	SOF	SRN	SEO	LS
Before Conversion	00_	○	○	○	○	○	○	○	○	○	○	○	○	○	○	○	○	○	○
	10_	○	○	○	○	○	○	○	○	○	○	○	○	○	○	○	○	○	○
	100_	○	○	○	○	○	○	○	○	○	○	○	○	○	○	○	○	○	○
	110_	○	○	○	○	○	○	○	○	○	○	○	○	○	○	○	○	○	○
	120_	○	○	○	○	○	○	○	○	○	○	○	○	○	○	○	○	○	○
	300_	○	○	○	○	○	○	○	○	○	○	○	○	○	○	○	○	○	○
	1020_	○	○	○	○	○	○	○	○	○	○	○	○	○	○	○	○	○	○
	SSV	○	○	○	○	○	○	○	○	○	○	○	○	○	○	○	○	○	○
	END	○	○	○	○	○	○	○	○	○	○	○	○	○	○	○	○	○	○
	STI	○	○	○	○	○	○	○	○	○	○	○	○	○	○	○	○	○	○
	SOK	○	○	○	○	○	○	○	○	○	○	○	○	○	○	○	○	○	○
	SWZ	○	○	○	○	○	○	○	○	○	○	○	○	○	○	○	○	○	○
	SWT	○	○	○	○	○	○	○	○	○	○	○	○	○	○	○	○	○	○
	SON	○	○	○	○	○	○	○	○	○	○	○	○	○	○	○	○	○	○
	SOF	○	○	○	○	○	○	○	○	○	○	○	○	○	○	○	○	○	○
	SRN	○	○	○	○	○	○	○	○	○	○	○	○	○	○	○	○	○	○
	SEO	○	○	○	○	○	○	○	○	○	○	○	○	○	○	○	○	○	○
LS	○	○	○	○	○	○	○	○	○	○	○	○	○	○	○	○	○	○	

■ Keyence KZ - A500 (Link I/F)

		After Conversion																	
		X	Y	M	L	B	F	M9	TS	TC	CS	CC	TN	CN	D	W	R	D9	LS
Before Conversion	X Input Relay	○	○	○	○	■	○	○	■	■	■	■	★	★	○	○	○	○	○
	Y Output Relay	○	○	○	○	■	○	○	■	■	■	■	★	★	○	○	○	○	○
	M Internal Relay	○	○	○	○	■	○	○	■	■	■	■	★	★	○	○	○	○	○
	L Latch Relay	○	○	○	○	■	○	○	■	■	■	■	★	★	○	○	○	○	○
	B Link Relay	■	■	■	■	■	■	■	■	■	■	■			○	■	■	■	■
	F Annunciator	○	○	○	○	■	○	○	■	■	■	■	★	★	○	○	○	○	○
	M9 Special Link Relay	○	○	○	○	■	○	○	■	■	■	■	★	★	○	○	○	○	○
	TS Timer (contact)	■	■	■	■	■	■	■	■	■	■	■			■	■	■	■	■
	TC Timer (coil)	■	■	■	■	■	■	■	■	■	■	■			■	■	■	■	■
	CS Counter (contact)	■	■	■	■	■	■	■	■	■	■	■			■	■	■	■	■
	CC Counter (coil)	■	■	■	■	■	■	■	■	■	■	■			■	■	■	■	■
	TN Timer (current value)	★	★	★	★		★	★					★	★	★	★	★	★	★
	CN Counter (current value)	★	★	★	★		★	★					★	★	★	★	★	★	★
	D Data Register	○	○	○	○	■	○	○	■	■	■	■	★	★	○	○	○	○	○
	W Link Data Register	○	○	○	○	■	○	○	■	■	■	■	★	★	○	○	○	○	○
	R File Register	○	○	○	○	■	○	○	■	■	■	■	★	★	○	○	○	○	○
	SD Special Data Register	○	○	○	○	■	○	○	■	■	■	■	★	★	○	○	○	○	○
LS System Area	○	○	○	○	■	○	○	■	■	■	■	★	★	○	○	○	○	○	



■ Keyence KV Series

		After Conversion													
		-	T	C	CTC	TS	CS	TC	CC	DM	TM	AT	CTH	CTC	LS
Before Conversion	Relay	■	■	■	■					■	■				■
	T Timer (contact)	■	■	■	■					■	■				■
	C Counter (contact)	■	■	■	■					■	■				■
	CTC High-Speed Counter Comparator (contact)	■	■	■	■					■	■				■
	TS Timer (set value)					★	★	★	★	★	★	★	★	★	★
	CS Counter (set value)					★	★	★	★	★	★	★	★	★	★
	TC Timer (current value)					★	★	★	★	★	★	★	★	★	★
	CC Counter (current value)					★	★	★	★	★	★	★	★	★	★
	DM Data Memory	■	■	■	■	★	★	★	★	○	○	★	★	★	○
	TM Temporary Data Memory	■	■	■	■	★	★	★	★	○	○	★	★	★	○
	AT Analog Timer					★	★	★	★	★	★	★	★	★	★
	CTH High-Speed Counter (current value)					★	★	★	★	★	★	★	★	★	★
	CTC High-Speed Counter Comparator (set value)					★	★	★	★	★	★	★	★	★	★
	LS LS area	■	■	■	■	★	★	★	★	○	○	★	★	★	○

■ Keyence Visual KV Series

		After Conversion													
		-	T	C	CTC	TC	CC	TS	CS	DM	TM	AT	CTH	CTC	LS
Before Conversion	Relay	○	■	■	■	★	★	★	★	○	○	★	★	★	○
	T Timer (contact)	■	■	■	■					■	■				■
	C Counter (contact)	■	■	■	■					■	■				■
	CTC High-speed Counter Comparator (contact)	■	■	■	■					■	■				■
	TC Timer (setup value)	★				★	★	★	★	★	★	★	★	★	★
	CC Counter (setup value)	★				★	★	★	★	★	★	★	★	★	★
	TS Timer (current value)	★				★	★	★	★	★	★	★	★	★	★
	CS Counter (current value)	★				★	★	★	★	★	★	★	★	★	★
	DM Data Memory	○	■	■	■	★	★	★	★	○	○	★	★	★	○
	TM Temporary Data Memory	○	■	■	■	★	★	★	★	○	○	★	★	★	○
	AT Digital Trimmer	★				★	★	★	★	★	★	★	★	★	★
	CTH High-speed Counter (current value)	★				★	★	★	★	★	★	★	★	★	★
	CTC High-speed Counter Comparator (setup value)	★				★	★	★	★	★	★	★	★	★	★
	LS LS Area	○	■	■	■	★	★	★	★	○	○	★	★	★	○

■ Keyence (Direct connections) KV-700 Series

		After Conversion															
		-	CR	T	C	CTC	TC	CC	TS	CS	DM	TM	CM	TRM	CTH	CTC	LS
Before Conversion	Relay	○	○	■	■	■	★	★	★	★	○	○	○	★	★	★	○
	Control Relay	○	○	■	■	■	★	★	★	★	○	○	○	★	★	★	○
	T Timer (contact)	■	■	■	■	■					■	■	■				■
	C Counter (contact)	■	■	■	■	■					■	■	■				■
	CTC High-speed Counter Comparator (contact)	■	■	■	■	■					■	■	■				■
	TC Timer (setup value)	★	★				★	★	★	★	★	★	★	★	★	★	★
	CC Counter (setup value)	★	★				★	★	★	★	★	★	★	★	★	★	★
	TS Timer (current value)	★	★				★	★	★	★	★	★	★	★	★	★	★
	CS Counter (current value)	★	★				★	★	★	★	★	★	★	★	★	★	★
	DM Data Memory	○	○	■	■	■	★	★	★	★	○	○	○	★	★	★	○
	TM Temporary Data Memory	○	○	■	■	■	★	★	★	★	○	○	○	★	★	★	○
	CM Memory Control	○	○	■	■	■	★	★	★	★	○	○	○	★	★	★	○
	TRM Digital Trimmer	★	★				★	★	★	★	★	★	★	★	★	★	★
	CTH High-speed Counter (current value)	★	★				★	★	★	★	★	★	★	★	★	★	★
	CTC High-speed Counter Comparator (setup value)	★	★				★	★	★	★	★	★	★	★	★	★	★
LS LS Area	○	○	■	■	■	★	★	★	★	○	○	○	★	★	★	○	

■ Keyence (Direct connections) KV-1000 Series

		After Conversion																					
		-	CR	MR	LR	T	C	CTC	TC	CC	TS	CS	DM	EM	FM	TM	CM	Z	TRM	CTH	CTC	LS	
Before Conversion	Relay	○	○	○	○	■	■	■	★	★	★	★	○	○	○	○	○	○	★	★	★	○	
	Control Relay	○	○	○	○	■	■	■	★	★	★	★	○	○	○	○	○	○	★	★	★	○	
	MR Internal Retain Relay	○	○	○	○	■	■	■	★	★	★	★	○	○	○	○	○	○	★	★	★	○	
	LR Latch Relay	○	○	○	○	■	■	■	★	★	★	★	○	○	○	○	○	○	★	★	★	○	
	T Timer (contact)	■	■	■	■	■	■	■					■	■	■	■	■	■				■	
	C Counter (contact)	■	■	■	■	■	■	■					■	■	■	■	■	■				■	
	CTC High-speed Counter Comparator (contact)	■	■	■	■	■	■	■					■	■	■	■	■	■				■	
	TC Timer (current value)	★	★	★	★				★	★	★	★	★	★	★	★	★	★	★	★	★	★	★
	CC Counter (current value)	★	★	★	★				★	★	★	★	★	★	★	★	★	★	★	★	★	★	★
	TS Timer (setup value)	★	★	★	★				★	★	★	★	★	★	★	★	★	★	★	★	★	★	★
	CS Counter (setup value)	★	★	★	★				★	★	★	★	★	★	★	★	★	★	★	★	★	★	★
	DM Data Memory	○	○	○	○	■	■	■	★	★	★	★	○	○	○	○	○	○	★	★	★	○	
	EM Expansion Data Memory	○	○	○	○	■	■	■	★	★	★	★	○	○	○	○	○	○	★	★	★	○	
	FM Expansion Data Memory	○	○	○	○	■	■	■	★	★	★	★	○	○	○	○	○	○	★	★	★	○	
	TM Temporary Data Memory	○	○	○	○	■	■	■	★	★	★	★	○	○	○	○	○	○	★	★	★	○	
	CM Control Memory	○	○	○	○	■	■	■	★	★	★	★	○	○	○	○	○	○	★	★	★	○	
	Z Index Register	○	○	○	○	■	■	■	★	★	★	★	○	○	○	○	○	○	★	★	★	○	
	TRM Digital Trimmer	★	★	★	★				★	★	★	★	★	★	★	★	★	★	★	★	★	★	★
	CTH High-speed Counter (current value)	★	★	★	★				★	★	★	★	★	★	★	★	★	★	★	★	★	★	★
	CTC High-speed Counter Comparator (setup value)	★	★	★	★				★	★	★	★	★	★	★	★	★	★	★	★	★	★	★
LS LS Area	○	○	○	○	■	■	■	★	★	★	★	○	○	○	○	○	○	★	★	★	○		

■ Shinkoh Technos SELMART

		After Conversion	
		D	LS
Before Conversion	Data Data Register	○	○
	LS System Area	○	○

■ Matsushita Electric Industrial Panadac 7000

		After Conversion																		
		IN	OT	RL	KR	LK	ST	MS	TS	TU	CU	CI	CO	M	LM	TM	CT	TC	PM	LS
Before Conversion	IN I/O Relay	○	○	○	○	○	○	○	○	○	○	○	○	○	○	★	★	★	★	○
	OT I/O Relay	○	○	○	○	○	○	○	○	○	○	○	○	○	○	★	★	★	★	○
	RL Internal Relay	○	○	○	○	○	○	○	○	○	○	○	○	○	○	★	★	★	★	○
	KR Hold Relay	○	○	○	○	○	○	○	○	○	○	○	○	○	○	★	★	★	★	○
	LK Link Relay	○	○	○	○	○	○	○	○	○	○	○	○	○	○	★	★	★	★	○
	ST Status Relay	○	○	○	○	○	○	○	○	○	○	○	○	○	○	★	★	★	★	○
	MS MC Status Relay	○	○	○	○	○	○	○	○	○	○	○	○	○	○	★	★	★	★	○
	TS Timer State Relay	○	○	○	○	○	○	○	○	○	○	○	○	○	○	★	★	★	★	○
	TU Timer Up Relay	○	○	○	○	○	○	○	○	○	○	○	○	○	○	★	★	★	★	○
	CU Count Up Relay	○	○	○	○	○	○	○	○	○	○	○	○	○	○	★	★	★	★	○
	CI CPU Input Relay	○	○	○	○	○	○	○	○	○	○	○	○	○	○	★	★	★	★	○
	CO CPU Output Relay	○	○	○	○	○	○	○	○	○	○	○	○	○	○	★	★	★	★	○
	M Data Memory	○	○	○	○	○	○	○	○	○	○	○	○	○	○	★	★	★	★	○
	LM Link Register	○	○	○	○	○	○	○	○	○	○	○	○	○	○	★	★	★	★	○
	TM Timer (current)	★	★	★	★	★	★	★	★	★	★	★	★	★	★	★	★	★	★	★
	CT Timer (current)	★	★	★	★	★	★	★	★	★	★	★	★	★	★	★	★	★	★	★
	TC Counter Value	★	★	★	★	★	★	★	★	★	★	★	★	★	★	★	★	★	★	★
	PM Position Data	★	★	★	★	★	★	★	★	★	★	★	★	★	★	★	★	★	★	★
LS System Area	○	○	○	○	○	○	○	○	○	○	○	○	○	○	○	○	○	○	○	

■ **Matsushita Electric Industrial MINAS-A/S Series**

		After Conversion	
		All Devices	LS
Before Conversion	All Devices	○	○
	LS System Area	○	○

■ **Orim Vexta E1 Series**

		After Conversion																	
		I	IU	ID	O	AD	DA	M	SL	SH	SR	SD	R	RD	B	MP	MS	SY	LS
Before Conversion	I Input Relay	○	○	○	○	○	○	○	○	○	○	○	○	○	○	○	○	○	○
	IU ON Event Input Register	○	○	○	○	○	○	○	○	○	○	○	○	○	○	○	○	○	○
	ID OFF Event Input Register	○	○	○	○	○	○	○	○	○	○	○	○	○	○	○	○	○	○
	O Output Register	○	○	○	○	○	○	○	○	○	○	○	○	○	○	○	○	○	○
	AD Analog Input Register	○	○	○	○	○	○	○	○	○	○	○	○	○	○	○	○	○	○
	DA Analog Output Register	○	○	○	○	○	○	○	○	○	○	○	○	○	○	○	○	○	○
	M Position Register	○	○	○	○	○	○	○	○	○	○	○	○	○	○	○	○	○	○
	SL Speed Register-Low	○	○	○	○	○	○	○	○	○	○	○	○	○	○	○	○	○	○
	SH Speed Register-High	○	○	○	○	○	○	○	○	○	○	○	○	○	○	○	○	○	○
	SR Speed Register-Increase	○	○	○	○	○	○	○	○	○	○	○	○	○	○	○	○	○	○
	SD Speed Register-Reduce	○	○	○	○	○	○	○	○	○	○	○	○	○	○	○	○	○	○
	R Common Register	○	○	○	○	○	○	○	○	○	○	○	○	○	○	○	○	○	○
	RD Common Expanded Register	○	○	○	○	○	○	○	○	○	○	○	○	○	○	○	○	○	○
	B Base Register	○	○	○	○	○	○	○	○	○	○	○	○	○	○	○	○	○	○
	MP Current Motor Position	○	○	○	○	○	○	○	○	○	○	○	○	○	○	○	○	○	○
	MS Current Motor Status	○	○	○	○	○	○	○	○	○	○	○	○	○	○	○	○	○	○
SY SY Register	○	○	○	○	○	○	○	○	○	○	○	○	○	○	○	○	○	○	
LS System Area	○	○	○	○	○	○	○	○	○	○	○	○	○	○	○	○	○	○	

■ Yamatake Yamatake SDC Series/DMC10

		After Conversion	
		Data	LS
Before Conversion	Data	○	○
	LS System Area	○	○

■ RKC Instrument CB/SR-Mini Series

		After Conversion	
		0000 to 02EE	LS
Before Conversion	0000 to 02EE	○	○
	LS	○	○

■ RKC Instrument CB/REX-F/LE100 series RKC protocol

		After Conversion			
		CB	REX	LE	LS
Before Conversion	CB	○	○	○	○
	REX	○	○	○	○
	LE	○	○	○	○
	LS	○	○	○	○

■ Shinkoh Technos C/FC/FIR/GC/FCL/PC-900 Series

		After Conversion			
		—	S	C	LS
Before Conversion	-----	○	○	○	○
	Setting Value Memory	○	○	○	○
	Channel	○	○	○	○
	LS Area LS	○	○	○	○

■ MEIDENSHA RC-100 Series (Ethernet connections)

		After Conversion	
		Memory	LS
Before Conversion	Memory	○	○
	LS Area LS	○	○

■ AL Series Temperature Controller, Fenwal Controls of Japan

		After Conversion	
		All Devices	LS
Before Conversion	All Devices	○	○
	LS Area LS	○	○

■ JE-70 Series Moisture Meter, JT Engineering

		After Conversion			
		M	D	R	LS
Before Conversion	M	<input type="radio"/>	<input type="radio"/>	<input type="radio"/>	<input type="radio"/>
	D	<input type="radio"/>	<input type="radio"/>	<input type="radio"/>	<input type="radio"/>
	R	<input type="radio"/>	<input type="radio"/>	<input type="radio"/>	<input type="radio"/>
	LS Area LS	<input type="radio"/>	<input type="radio"/>	<input type="radio"/>	<input type="radio"/>

■ Shimaden SR253/SR90/SR80/MR13/FP93/SD16/EM70 Series

		After Conversion	
		Data Address	LS Area
Before Conversion	Data Address	<input type="radio"/>	<input type="radio"/>
	LS Area	<input type="radio"/>	<input type="radio"/>

■ CHINO Corporation Controllers LT/JU Series

Device Name		After Conversion			
		Digital Setting Value	Digital Input Data	Analog Input Data	Analog Setting Value
Before Conversion	Digital Setting Value	<input type="checkbox"/>	<input type="checkbox"/>	<input type="checkbox"/>	<input type="checkbox"/>
	Digital Input Data	<input type="checkbox"/>	<input type="checkbox"/>	<input type="checkbox"/>	<input type="checkbox"/>
	Analog Input Data	<input type="checkbox"/>	<input type="checkbox"/>	<input type="radio"/>	<input type="radio"/>
	Analog Setting Value	<input type="checkbox"/>	<input type="checkbox"/>	<input type="radio"/>	<input type="radio"/>

■ Toshiba Schneider Inverter VF-S9/VF-nC1/VF-S11/VF-A7 Series

		After Conversion															
		00	01	02	03	04	05	06	07	08	09	FA	FB	FC	FD	FE	LS
Before Conversion	Basic Parameter 00	<input type="radio"/>	<input type="radio"/>	<input type="radio"/>	<input type="radio"/>	<input type="radio"/>	<input type="radio"/>	<input type="radio"/>	<input type="radio"/>	<input type="radio"/>	<input type="radio"/>	<input type="radio"/>	<input type="radio"/>	<input type="radio"/>	<input type="radio"/>	<input type="radio"/>	<input type="radio"/>
	Extended Parameter 01	<input type="radio"/>	<input type="radio"/>	<input type="radio"/>	<input type="radio"/>	<input type="radio"/>	<input type="radio"/>	<input type="radio"/>	<input type="radio"/>	<input type="radio"/>	<input type="radio"/>	<input type="radio"/>	<input type="radio"/>	<input type="radio"/>	<input type="radio"/>	<input type="radio"/>	<input type="radio"/>
	Extended Parameter 02	<input type="radio"/>	<input type="radio"/>	<input type="radio"/>	<input type="radio"/>	<input type="radio"/>	<input type="radio"/>	<input type="radio"/>	<input type="radio"/>	<input type="radio"/>	<input type="radio"/>	<input type="radio"/>	<input type="radio"/>	<input type="radio"/>	<input type="radio"/>	<input type="radio"/>	<input type="radio"/>
	Extended Parameter 03	<input type="radio"/>	<input type="radio"/>	<input type="radio"/>	<input type="radio"/>	<input type="radio"/>	<input type="radio"/>	<input type="radio"/>	<input type="radio"/>	<input type="radio"/>	<input type="radio"/>	<input type="radio"/>	<input type="radio"/>	<input type="radio"/>	<input type="radio"/>	<input type="radio"/>	<input type="radio"/>
	Extended Parameter 04	<input type="radio"/>	<input type="radio"/>	<input type="radio"/>	<input type="radio"/>	<input type="radio"/>	<input type="radio"/>	<input type="radio"/>	<input type="radio"/>	<input type="radio"/>	<input type="radio"/>	<input type="radio"/>	<input type="radio"/>	<input type="radio"/>	<input type="radio"/>	<input type="radio"/>	<input type="radio"/>
	Extended Parameter 05	<input type="radio"/>	<input type="radio"/>	<input type="radio"/>	<input type="radio"/>	<input type="radio"/>	<input type="radio"/>	<input type="radio"/>	<input type="radio"/>	<input type="radio"/>	<input type="radio"/>	<input type="radio"/>	<input type="radio"/>	<input type="radio"/>	<input type="radio"/>	<input type="radio"/>	<input type="radio"/>
	Extended Parameter 06	<input type="radio"/>	<input type="radio"/>	<input type="radio"/>	<input type="radio"/>	<input type="radio"/>	<input type="radio"/>	<input type="radio"/>	<input type="radio"/>	<input type="radio"/>	<input type="radio"/>	<input type="radio"/>	<input type="radio"/>	<input type="radio"/>	<input type="radio"/>	<input type="radio"/>	<input type="radio"/>
	Extended Parameter 07	<input type="radio"/>	<input type="radio"/>	<input type="radio"/>	<input type="radio"/>	<input type="radio"/>	<input type="radio"/>	<input type="radio"/>	<input type="radio"/>	<input type="radio"/>	<input type="radio"/>	<input type="radio"/>	<input type="radio"/>	<input type="radio"/>	<input type="radio"/>	<input type="radio"/>	<input type="radio"/>
	Extended Parameter 08	<input type="radio"/>	<input type="radio"/>	<input type="radio"/>	<input type="radio"/>	<input type="radio"/>	<input type="radio"/>	<input type="radio"/>	<input type="radio"/>	<input type="radio"/>	<input type="radio"/>	<input type="radio"/>	<input type="radio"/>	<input type="radio"/>	<input type="radio"/>	<input type="radio"/>	<input type="radio"/>
	Extended Parameter 09	<input type="radio"/>	<input type="radio"/>	<input type="radio"/>	<input type="radio"/>	<input type="radio"/>	<input type="radio"/>	<input type="radio"/>	<input type="radio"/>	<input type="radio"/>	<input type="radio"/>	<input type="radio"/>	<input type="radio"/>	<input type="radio"/>	<input type="radio"/>	<input type="radio"/>	<input type="radio"/>
	Instruction-related FA	<input type="radio"/>	<input type="radio"/>	<input type="radio"/>	<input type="radio"/>	<input type="radio"/>	<input type="radio"/>	<input type="radio"/>	<input type="radio"/>	<input type="radio"/>	<input type="radio"/>	<input type="radio"/>	<input type="radio"/>	<input type="radio"/>	<input type="radio"/>	<input type="radio"/>	<input type="radio"/>
	Instruction-related FB	<input type="radio"/>	<input type="radio"/>	<input type="radio"/>	<input type="radio"/>	<input type="radio"/>	<input type="radio"/>	<input type="radio"/>	<input type="radio"/>	<input type="radio"/>	<input type="radio"/>	<input type="radio"/>	<input type="radio"/>	<input type="radio"/>	<input type="radio"/>	<input type="radio"/>	<input type="radio"/>
	Monitor-related FC	<input type="radio"/>	<input type="radio"/>	<input type="radio"/>	<input type="radio"/>	<input type="radio"/>	<input type="radio"/>	<input type="radio"/>	<input type="radio"/>	<input type="radio"/>	<input type="radio"/>	<input type="radio"/>	<input type="radio"/>	<input type="radio"/>	<input type="radio"/>	<input type="radio"/>	<input type="radio"/>
	Monitor-related FD	<input type="radio"/>	<input type="radio"/>	<input type="radio"/>	<input type="radio"/>	<input type="radio"/>	<input type="radio"/>	<input type="radio"/>	<input type="radio"/>	<input type="radio"/>	<input type="radio"/>	<input type="radio"/>	<input type="radio"/>	<input type="radio"/>	<input type="radio"/>	<input type="radio"/>	<input type="radio"/>
	Monitor-related FE	<input type="radio"/>	<input type="radio"/>	<input type="radio"/>	<input type="radio"/>	<input type="radio"/>	<input type="radio"/>	<input type="radio"/>	<input type="radio"/>	<input type="radio"/>	<input type="radio"/>	<input type="radio"/>	<input type="radio"/>	<input type="radio"/>	<input type="radio"/>	<input type="radio"/>	<input type="radio"/>
	LS Area LS	<input type="radio"/>	<input type="radio"/>	<input type="radio"/>	<input type="radio"/>	<input type="radio"/>	<input type="radio"/>	<input type="radio"/>	<input type="radio"/>	<input type="radio"/>	<input type="radio"/>	<input type="radio"/>	<input type="radio"/>	<input type="radio"/>	<input type="radio"/>	<input type="radio"/>	<input type="radio"/>



■ UBON UPZ Series

Device Name		After Conversion													
		Input Relay I (R40400 to R40437)	Output Relay Q (R40500 to R40537)	Internal Relay M (R40600 to R40677)	Stage S (R41000 to R41037)	Special Relay SP (R41200 to R41237)	Timer T (R41100 to R41117)	Counter C (R41140 to R41147)	Timer (Elapsed Time) (R000 to R377)	Counter (Elapsed Time) (R1000 to R1177)	Data Register (R1400 to R7377)	Data Register (R10000 to R17777)	Special Register (R7400 to R7777)	Special Register (R37000 to R37777)	LS
Before Conversion	Internal Relay I (R40400 to 40437)	○	○	○	○	○	◆	◆	○	○	○	○	○	○	○
	External Relay Q (R40500 to R40537)	○	○	○	○	○	◆	◆	○	○	○	○	○	○	○
	Internal Relay M (R40600 to R40677)	○	○	○	○	○	◆	◆	○	○	○	○	○	○	○
	Stage S (R41000 to R41037)	○	○	○	○	○	◆	◆	○	○	○	○	○	○	○
	Special Relay SP (R41200 to R41237)	○	○	○	○	○	◆	◆	○	○	○	○	○	○	○
	Timer T (R41100 to R41117)	◆	◆	◆	◆	◆	○	○	◆	◆	◆	◆	◆	◆	◆
	Counter C (R41140 to R41147)	◆	◆	◆	◆	◆	○	○	◆	◆	◆	◆	◆	◆	◆
	Timer (Elapsed Time) (R000 to R377)	○	○	○	○	○	◆	◆	○	○	○	○	○	○	○
	Counter (Elapsed Time) (R1000 to R1177)	○	○	○	○	○	◆	◆	○	○	○	○	○	○	○
	Data Register (R1400 to R7377)	○	○	○	○	○	◆	◆	○	○	○	○	○	○	○
	Data Register (R10000 to R17777)	○	○	○	○	○	◆	◆	○	○	○	○	○	○	○
	Special Register (R7400 to R7777)	○	○	○	○	○	◆	◆	○	○	○	○	○	○	○
	Special Register (R37000 to R37777)	○	○	○	○	○	◆	◆	○	○	○	○	○	○	○
LS	○	○	○	○	○	◆	◆	○	○	○	○	○	○	○	

■ Hioki E.E. Corporation Controller Smart Site

		After Conversion				
		0	1	4	3	LS
Before Conversion	Coils 0	○	○	○	○	○
	Discrete Input 1	○	○	○	○	○
	Holding Register 4	○	○	○	○	○
	Input Register 3	○	○	○	○	○
	System Area (LS)	○	○	○	○	○

## A.4 Software Trouble Report

### ■ When problems continue after following “Troubleshooting” advice

If following the steps outlined in the troubleshooting section does not solve your problem, please make a copy of the next page’s Software Trouble Report, fill in any relevant information, and fax it to your local Pro-face service center.

Please include any relevant details, including project data and/or screens so that the problem can be duplicated. We guarantee all this data will remain confidential.

Also, please take the time to use the “OSCHECK” tool installed with your GP-PRO/PBIII software, and include a printout of its result with your fax.

#### Using the “OSCHECK” Program

This program, after it completes its test, produces a text file (\*.txt). Please be sure to print out this data and include it with your Software Trouble Report.

- 1) Click on the Windows main screen’s [Start] button and then on the [Run] selection.
- 2) Here, use the [Browse] feature to find the OSCHECK.EXE program, located in your PC’s “ProPBWin” folder. Once you find it, click on  to start the program.
- 3) Designate the status report’s Save folder and filename.
- 4) Click again on  and the text file will be created.



- ***When inquiring, be sure to write down your software’s serial No. Without your software’s serial No., your question(s) cannot be answered.***
- ***Understand that it may take some time for us to respond, since your question must be carefully checked and recreated.***

#### Pro-face FAX and Email Information:

- **Pro-face Europe:** FAX No. +31-(0)23-55-44-090 Email: support@proface.com
- **Pro-Face Korea:** FAX No. +82-(0)2-2630-9860 Email: proface@proface.co.kr
- **Pro-Face Taiwan:** FAX No. +886-(0)2-2507-1104 Email: proface@proface.com.tw
- **Pro-face America / Xycom (North and South):** FAX No. +1-734-429-1010  
Email: support@profaceamerica.com

#### Digital (Japan) FAX and Email Information:

- **Digital Electronics Corporation:** FAX No. +81-(0)6-6613-5982 Email: support@digital.co.jp
- Also, if you require instruction about the correct usage of your GP-PRO/PBIII for Windows software, please use the above information to contact your local GP-PRO/PBIII distributor.



# *Memo*

# INDEX

## A

Adding Alarm Data	5-21
Address Conversion when changing the PLC	6, 7, 11, 12, 13
Address Increment	2-220, 2-221
Address Map Display	2-297
Address Range Conversion	2-236
Alarm Color	2-18
Alarm Creation and Editing	5-2
Alarm Editor	5-3
Alarm Export	5-29
Alarm Import	5-30
Alarm Message/Summary Screen	5-3
Alarm Range	2-18, 2-19
Alarm Settings	2-17
Alarm Summary [Description] Attributes	2-112
Alarm Type	2-17
Aligning Object Positions	2-227
Automatically create file name	2-240

## B

Backlight Color Change	2-324
Backup Data Creation	10-9
Bar Graph [General Settings] Attributes	2-49
Bit Alarm Log	5-6
Bit Switch [Shape/Color] Attributes	2-25, 2-26
Blink	2-16
Border Type	2-131
Browsing Help Topics	1-23

## C

Calling up Device Comments	4-99
Canceling an Action	2-243
Cautions When Converting GP-PRO Files	12-11
CD-ROM	1
CD-ROM Usage Precautions	20
CF -> Device/PLC	2-132
CF BOOT	10-23
CF Card Tool	10-4, 10-9
Change Order	2-289
Changing a Project's GP Type	4-20
Changing Alarm Attributes	5-23
Changing Attributes	2-235
Changing Display Addresses	2-299
Changing Screen Numbers and Titles	4-5
Changing the Device/PLC type	4-22

Changing the Extend SIO Type	4-32
Changing the Order of Overlapping Objects	2-234
Chapter Breakdown	15
Character (Reference) Codes	3-13
Character Size	2-136, 2-190
Chinese character fonts	12-12
CLOSE	10-24
Color	2-131, 2-136
Colors	2-12
Communication Port	7-5, 7-6
Compare List	7-24
Comparing Projects	4-46
COMPARISON	10-32
COMPARISON Status	10-33, 10-34
Configuring a Data Transfer Display	2-133
Confirming Addresses	2-236
Convert DXF Size	2-334, 2-340
Converting a GP-PRO II/GP-PRO III File	12-4
Converting a GPM File	12-14
Converting a Parts Box File	12-9
Converting a Screen into a Bitmap File	2-241
Converting and Placing a Bitmap	2-200
Converting Data	44
Converting Data (DXF to PRW)	2-333
Converting DXF File Data	2-337
Converting/Placing a Bit Map	3-57
Converting/Placing an Image: [Destination]	3-59
Converting"Parts Box" Data	46
Copying a Part on the Parts List	2-291
Copying Screens	4-3
Copying Text	3-41
Copying Window Registration Data	3-83
copyrights	1
Cover Page Dialog Box	9-3
Create backup data	10-14
Create system boot data of CF Card	10-14
Creating a Dot	2-173
Creating a Keypad	3-32
Creating a New Library File	2-246
Creating a New Project	1-3
Creating a Trend Graph	3-26
Creating Labels	2-19
Cross Reference	2-295
CSV Data Transfer Function	10-3
CSV Display	2-135
CSV Display [Extend] Attributes	2-138

## Index

CSV Display [General Settings] Attributes	2-136	Editing an Object	2-289
CSV Display [Switch Settings] Attributes	2-138	Editing D-Script Settings	2-265
CSV Display [Switch Type/Color] Attributes	2-138	Editing Items on the Part Reference List	2-290
Cutting a Library Item (from a Library File)	2-257	Editing Library Items	2-245
Cutting a Mark	3-15	Editing the Pop-up Keypad	2-107
Cutting/Pasting Text	3-40	Editing Tools	3-3
<b>D</b>		Editing via the Load Screen List	2-301
D-Script Tool Box	2-263, 2-270	Editing Windows	3-80
D-Scripts/Global D-Script	2-262	Entering Addresses	2-5
Data Conversion from LogiTouch Editor	46	Entering from a keyboard	2-5
Data Logging Display [General Settings] Attributes	2-123	Entering from a pop-up keypad	2-6
Data Transfer Display	2-129	Entering from a pull-down list	2-7
Data Transfer Display [Display] Attributes	2-131	Entering from an address keypad	2-6
Data Transfer Display [General Settings] Attribute	2-129	Entering Text	2-192
Data Transfer Display [Style/Color] Attributes	2-131	Error Pattern by Symptom	App-25
Data Transfer Display [Switch Settings] Attributes	2-132	Ethernet	7-27
Data Transfer Display [Switch Type/Color] Attribute	2-132	ETHERNET SETUP screen	7-28
Date Display [General Settings] Attributes	2-158	Exporting a CSV File	2-292, 2-294
Definition of Functions	2-264, 2-271	Extended Screen Count	4-50
Deleting a Home Page Address	1-26	Extended Settings	6-7
Deleting D-Script Settings	2-265	Extended SIO Script	2-269
Deleting Windows	3-80	<b>F</b>	
Device Address	2-285	Factory Settings	7-28
Device Allocation Table	14	Features of 4-State Lamp	2-46
Device Comment Types	4-93	File Manager Display [General Settings] Attributes	2-142
Device Monitor Information	4-50	File Manager Display [Switch Setting] Attributes	2-143
Device/PLC -> CF	2-132	File Name Display [General Settings] Attributes	2-117
Display Area (50%, 100%, 200%)	1-21	Fill	2-282
Display Column	2-136	Fill Point Color	2-286
Display in Load Screen Object	2-283	Filling a Mark	3-9
Displaying (Calling up) a Special Character	3-12	formal trade names	2
Dot Attributes	2-173	Freehand Drawing	3-5
DOWNLOAD	10-24, 10-28	Function Buttons	1-17
DOWNLOAD Status	10-29	Function Key Settings	2-305, 2-320
Drawing a Circle	3-8	Function Switch [General Settings] Attributes	2-33
Drawing Tools	2-171, 3-2	Functions	2-25
Drawing with Dots	3-4	<b>G</b>	
Duplicate Setting Dialog Box	2-220	General GP Restrictions	21
Duplicating	2-223	General Information Symbols and Terms	18
<b>E</b>		Global Cross Reference	2-296
Edit	2-136	GLOBAL INTERLOCK	2-277
Editing a Channel	3-30	Global Window Display	3-84
		GP data transfer cable	10-13
		GP Dip Switches	10-23
		GP Series Compatibility	44

GP Series Product Names	3, 4, 5	Listing Screens	4-2
GP Version	7-24	Loading a Mark Screen	2-199
GP-PRO/PB III Manuals and Help	1-22	Loading a Screen	2-197
Grayscale(Normal) Option	3-61	Local Function Key Setup	2-306, 2-321
Grid/Snap Settings dialog box	2-279	Local Window Display	3-84
Grouping Objects	2-232		
<b>H</b>		<b>M</b>	
Half Pie Graph [General Settings] Attributes	2-59	Manual Symbols and Terminology	17
Hex/Decimal Corresponding Character Codes	3-14	Mark Drawing Area Structure	3-4
How to Move an Object	2-215	Maximum Number of Automatically Created Part Libra	2-22
How to Select a Single Object	2-210	Maximum Number of Tags	4-52
How to Select Multiple Objects	2-211	Memory Information	7-23, 7-24
How to Use This Manual	14	MEMORY LOADER TOOL	10-24
<b>I</b>		MENU	10-24
I/O Settings	6-6	Menu Screen	10-25
ID Numbers	2-21	Message Display [General Settings] Attributes	2-151
Importing Symbols and Device Comments	4-95	Meter Graph [General Settings] Attributes	2-69
Importing/Exporting the "Action" information on th	2-271	Mirror X, Mirror Y	3-21
Initial Screen Settings	6-7, 6-11	Mode Settings	6-6
Initial Start Mode screen	7-28	Modifying Library File Names	2-247
Interlock	2-26, 2-95, 2-96, 2-139	Monitor Bit Address	2-24
		Moving Symmetrically	2-230
		MultiLanguage Text Screens	3-46
<b>J</b>		<b>N</b>	
Justification	2-192	Nesting	2-196
<b>K</b>		Network Data Search	7-30
Keyboard Compatibility List	19	No. of Display Characters	2-131
Keypad [Description] Attributes	2-86	No. of Display Lines	2-131
Keypad Display [Display Format] Attributes	2-92	Node List/Send screens	7-30
Keypad Display [General Settings] Attributes	2-90	Number of Copies	2-220
Keypad Display [Specify Entering Order] feature	2-92	Numeric Display [General Settings] Attributes	2-146
<b>L</b>		<b>O</b>	
Label] Attributes	2-25	Opening a New Screen	1-10
Lamp [General Setting] Attributes	2-43	Opening a Previously Saved Screen	1-11
Library Browser	2-244	Operation Bit Address	2-24
Library Size	2-245	Options Dialog Box	9-3
Line Type Conversion DXF to PRW)	2-335	Otasuke Pro!	1-29
Line/Polyline Attributes	2-174	overseas products	1
Link Select	2-288	<b>P</b>	
List Display	2-297, 2-298, 2-299	Parts	2-2
List of GLC Series Products	4	Parts Box File	12-8
List of Supported Factory Gateway	5	Parts Palette	6, 11
List Screens	7-22	Passwords	7-11
		PDB File	2-8, 2-9

Picture Display [Description] Attributes.	2-163	RETURN	10-27, 10-29, 10-33
Pie Graph [General Settings] Attributes	2-54	Rotating an Object	2-228
Placing a Bar Graph	2-52	<b>S</b>	
Placing a Bit Switch	2-27	SCREEN DATA	10-30
Placing a CSV Display	2-140	Status 1	10-27, 10-33
Placing a File Manager Display	2-144	Safety Symbols and Terms	17, 18
Placing a Function Switch	2-37	Sample Printer Output	9-9
Placing a Half Pie Graph	2-62	Saving a Project	1-7
Placing a Lamp	2-44	Saving a Project File under a Different Name	1-8
Placing a Part in Position	2-22	SCREEN DATA	10-31
Placing a Pie Graph	2-57	Screen Data After Conversion	12-11
Placing a Tank Graph	2-67	Screen Data List	2-288
Placing a Toggle Switch	2-41	Screen Editor Item Names	1-18
Points to Consider when Creating Tags	2-202	Screen Information	4-51
PRECAUTIONS	20	Screens that can be loaded to other screens	2-195
PREFACE	1	Searching for a Topic and then Display Help	1-23
Print Preview Screen	9-8	Searching for a Topic from the Contents Menu	1-23
Printing - [Print] Tab	9-2	Searching for Text	3-43
Printing - [Project Information] Tab	9-4	Security Feature	4-68
Printing - [Screen] Tab	9-5	Selecting a GP-PRO II/III File	12-3
Printing Example	5-5	Selecting a Part Shape	2-7
Product Usage Precautions	20	Selecting a Parts Box File	12-8
Project Information	4-49	Selecting Colors	2-12
Project Manager Areas and Functions	1-16	Selecting Line Types	2-171
Protect Setting	4-38	Send backup data	10-14
<b>Q</b>		Send system boot data to CF Card	10-14
Q-tag extended features	5-2	Setting Bitmap File Name	2-240
Quitting GP-PRO/PBIII for Windows	1-15	Setting Screen Property	2-282
<b>R</b>		Setting the Extended SIO Script	2-270, 2-272
Reading a GPM File	12-17	Setting Up Data Sampling	2-276
Rebuilding	4-14	Setting up Tags	2-206
Receive backup data	10-15	Setting Up Your GP via an Ethernet Network	7-27
Receiving Data Stored on the CF Card	7-26	Setup - Transferring Data	7-9
Redrawing a Screen	2-242	SIMULATION	8-1
Reflecting Device Comments	5-25	Simulation (Ethernet)	8-13
Reflection of a Device Comment	2-4	Simulation Protocol	8-10
Reflection of Device Comments	2-222	Software and GP Setting Controls	21
Registering a Password	7-11	Spacing	2-220
Registering D-Script Settings	2-263	SRAM Information	4-50
Registering D-Script settings	2-267	Starting GP-PRO/PB III for Windows	1-2
Registering Data Sampling Settings	2-275	States	2-17
Registering Symbols and Device Comments	4-94	Status 1	10-29
Registering Windows	3-79	Status 2	10-27, 10-29, 10-33
Requirements for 32-bit data	12-12	Status Address	2-137, 2-143
Restrictions for using Pop-up Keypad	2-106	Status Bar	10-27, 10-29, 10-33



Swap Serial I/F	4-32
Swap Serial I/F (Serial I/F Switch)	4-32
Switching Library Files	2-246
Symbol Editor Types	4-92
System Configuration	7-27
SYSTEM DATA	10-30, 10-31
SYSTEM DATA DISPLAY	10-30
SYSTEM DATA DISPLAY (CF CARD's DATA)	10-31
SYSTEM DATA DISPLAY (INTERNAL DATA)	10-30

## V

Version Information	4-52
---------------------	------

## W

Window Mark	2-283
Window Parts Attributes	2-169
Word Alarm Log	5-10

## T

Tag Layout Sheet	14
Tag Mark	2-284
Tag Settings	2-205
Tank Graph [General Settings] Attributes	2-64
Text Attributes	2-189
Text Screen Import/Export	3-50
Text Table Converter	4-65
Tiling Patterns	2-172
Time Display [General Settings] Attributes	2-161
Time-Base function	2-109, 2-150
Toggle Switch [General Settings] Attributes	2-39
Tool/Icon Display	1-21
TRADEMARK RIGHTS	2
Trademark Rights	2
Transfer Preparation	7-15
Transfer Settings	7-29
Transfer Status Address	2-130
Transferring a Screen to the Clipboard	2-239
Transparent/Background Color	3-23
Trend Graph [Alarm Settings] Attributes	2-81
Trend Graph [Assist Line] Attributes	2-81
Trend Graph [Channel Setting] Attributes	2-80
Trend Graph [General Settings] Attributes	2-74
Trend Graph [Shape/Color] Attributes	2-81
Turn Counterclockwise	3-21
Types of Editing Functions	2-208
Typical User Configuration	19

## U

UPLOAD Status	10-27
UPLOAD	10-24, 10-25
UPLOAD DATA SIZE	10-30, 10-31
Used Hairline Cursor	2-285
Utilizing Other Text Files	3-44, 3-48, 3-54, 3-55

# *Memo*