

EBDSM-PRM

Ceiling PIR presence/absence detector

Overview



The EBDSM-PRM PIR (passive infrared) presence detector provides automatic control of lighting loads with optional manual control.

The output channel comprises a mains voltage relay capable of simple on/off switching.

Functioning as a presence detector, the unit can turn lights on when a room is occupied and off when the room is empty. Optional settings allow lights to be turned off in response to ambient daylight.

All functionality is fully programmable using an IR handset.

Features

Front features

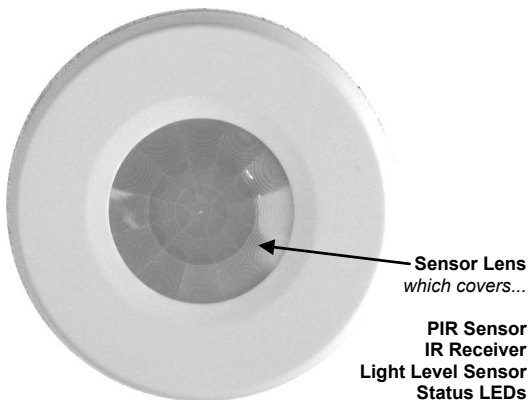

PIR Sensor

Detects movement within the unit's detection range, allowing load control in response to changes in occupancy.

IR Receiver

Receives control and programming commands from an IR (infrared) handset.

Light Level Sensor

Measures the overall light level in the detection area

Status LEDs

The LED flashes Red to indicate the following:

Walk Test LED active	when movement is detected
Valid setting received	

Back features

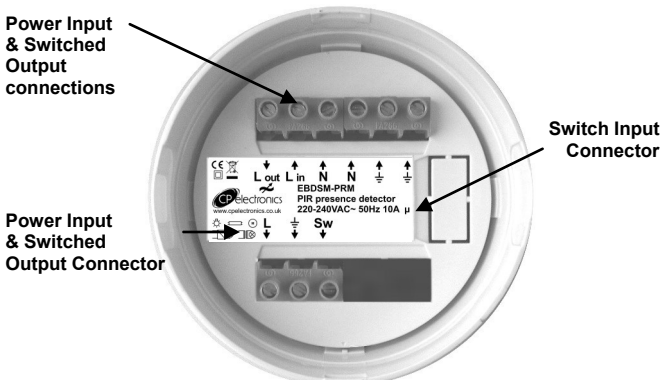

Power Input & Switched Output Connector

Used to connect mains power to the unit and to connect a switched load.

Switch Input Connector

Two input terminals can be used to manually override the lights on or off.

Detection diagram

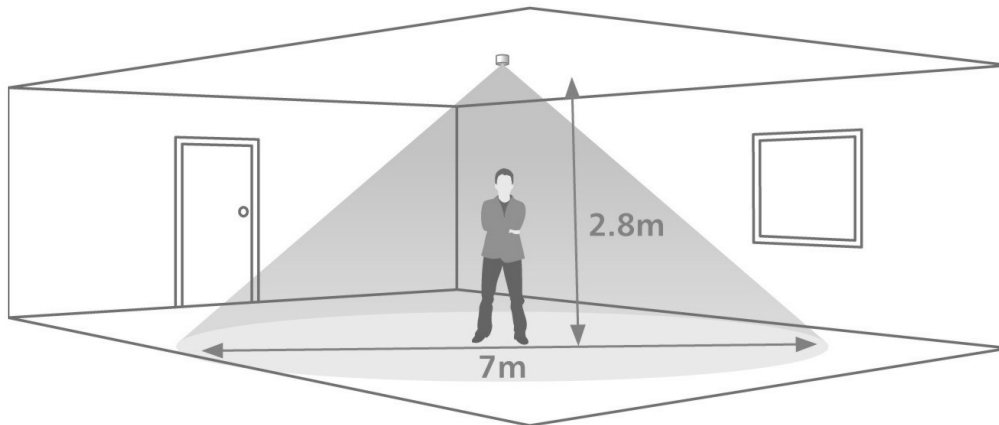

Area of high sensitivity  Area of lower sensitivity 

Sensor functionality

Detection Mode

The Detection Mode can be set to behave in Presence or Absence mode:

- **Presence** When movement is detected the load will automatically turn on. When the area is no longer occupied the load will automatically switch off after an adjustable time period.
- **Absence** The load is manually switched on. When the area is no longer occupied the load will automatically switch off after the adjustable time period has elapsed.

In either case, sensitivity to movement of the PIR sensor can be adjusted using the Sensitivity parameter.

HINT: To assist in setting the Sensitivity, turn on the Walk Test LED which will flash red when movement is detected.

Switch Level On/Off

Occupancy detection can be made dependant on the ambient light level using the Lux On Level and Lux Off Level parameters.

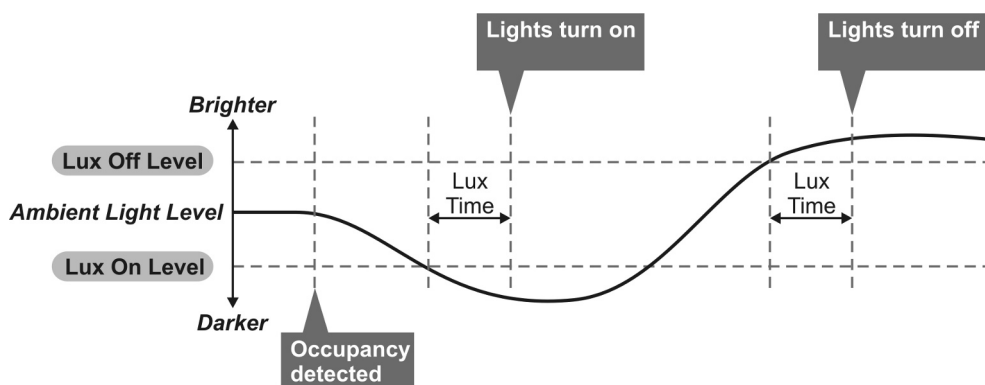

Choosing a Suitable Location

The EBDSM-PRM is designed to be ceiling mounted and must satisfy the following criteria:

- Avoid positioning the unit where direct sunlight may enter the sensor element.
- Do not site the sensor within 1m of any lighting, forced air heating or ventilation.
- Do not fix the sensor to an unstable or vibrating surface.

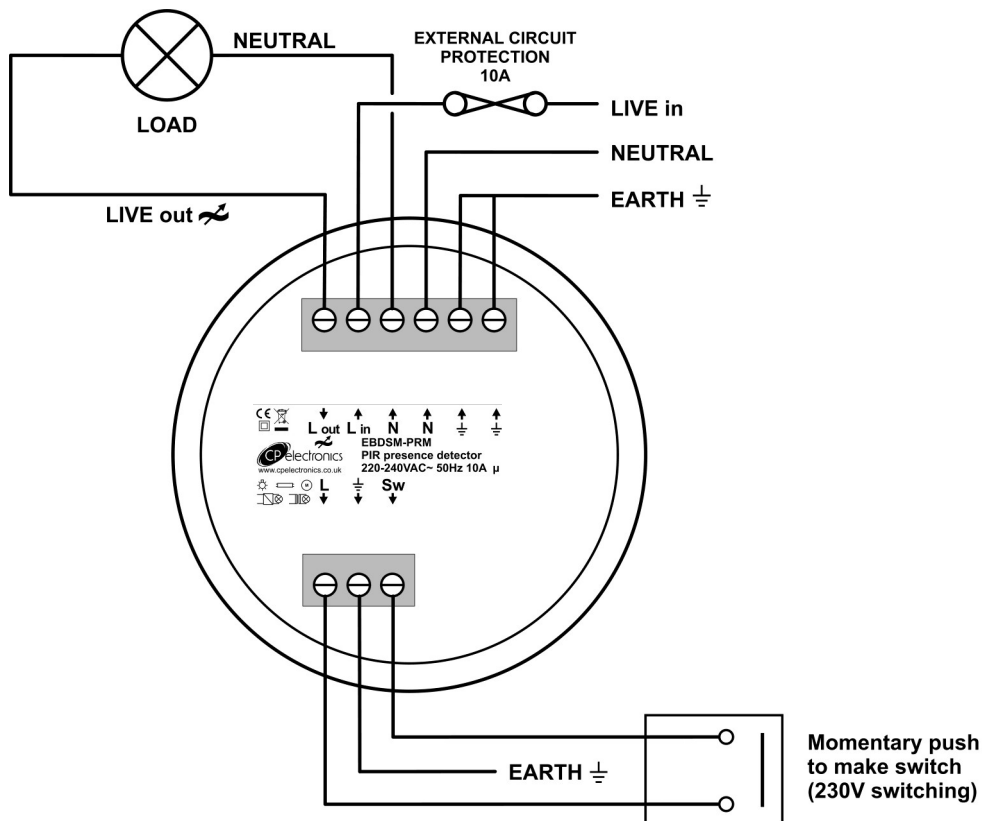

Absence detection

- To use absence detection a retractive (momentary) switch must be connected between the 2 terminals on the diagram. Note that this will be switching mains voltage.
- The unit ships with presence detection as default. To change to absence detection, press and release the external switch 5 times within the first minute of power up. The LED will turn on solid for 30 seconds to indicate absence mode has been selected.
- To change back to presence detection, repeat the above procedure—the LED will flash for 30 seconds to indicate presence mode has been selected.

Note: the above adjustments can also be made using the UHS5 or UNLCDHS handsets. See Programming sections.

Power-up test procedure

When power is applied to the unit, the load will turn on immediately.

Set the timeout to 10 seconds, vacate the room or remain very still and wait for the load to switch off .

Check that the load switches on when movement is detected.

The unit is now ready for programming.

Installation

Choosing a suitable location

The EBDSM-PRM is designed to be ceiling mounted and must satisfy the following criteria:

- The sensor should be sited so that the occupants of the room fall inside the detection pattern overleaf, at a recommended height of 2.8m on the ceiling. Note that the lower the sensor is installed the smaller the detection range will be, subject to the parameters shown on the diagram.
- Avoid positioning the sensor where direct sunlight may enter the sensor element.
- Do not site the sensor within 1m of any lighting, forced air heating or ventilation.
- Do not fix the sensor to an unstable or vibrating surface.

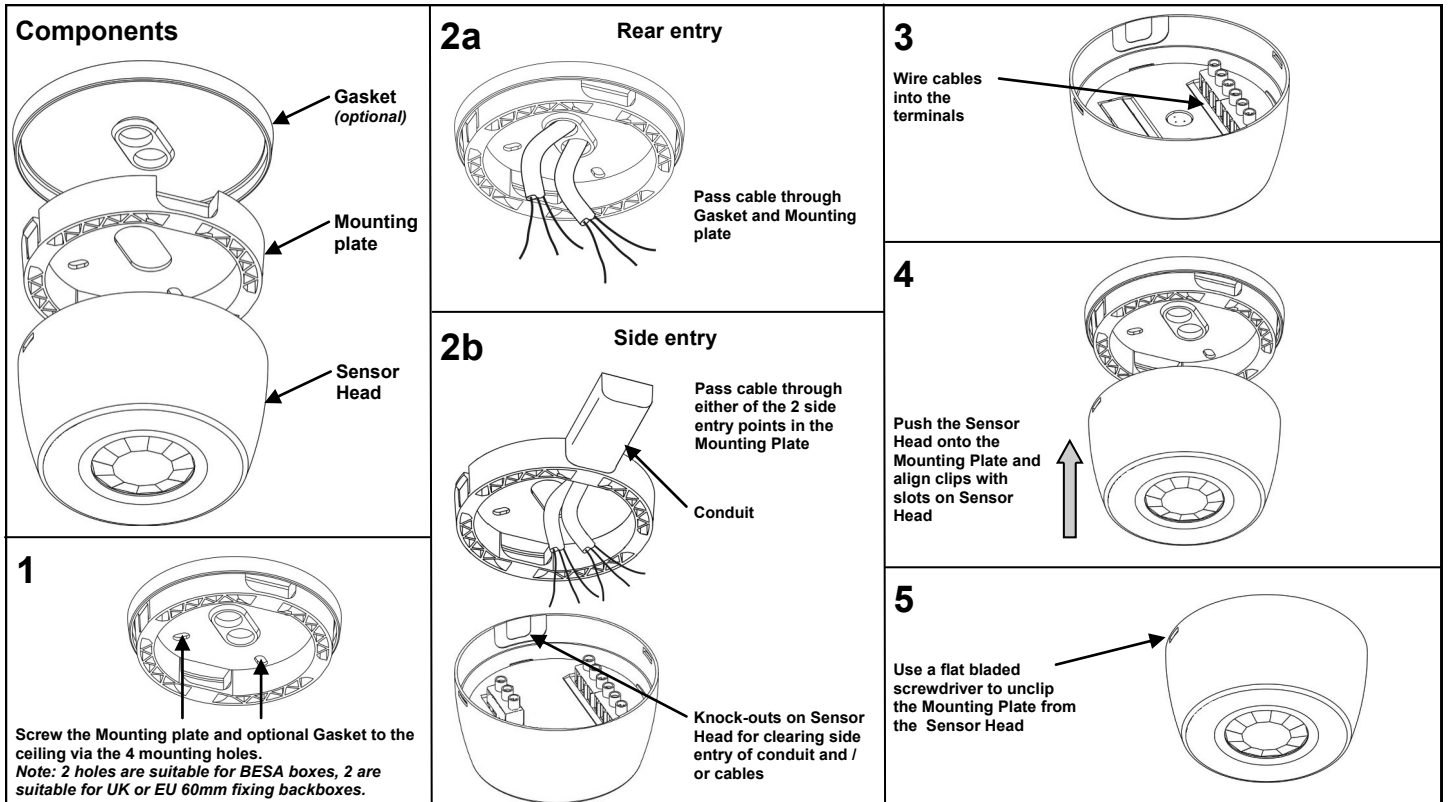

Readback function (UNLCDHS handset only)

The UNLCDHS has the ability to read back the settings stored in a device.

To read back individual parameters

- Navigate to the parameter and press the 'R' (Read) button whilst pointing at the device. The handset will click when the parameter has been read back, the device will flash its LED, and the value will be shown against the parameter in the menu.

To read back all of the parameters in a menu

- Press and hold the 'R' (Read) button for more than 1 second.
- The handset will click every time a parameter is received
- The device will show multiple flashes of its LED
- All of the values will be shown against the parameters in the menu.
- The individual parameters may be edited and then saved as a 'Macro'.

Notes

- If a parameter(s) has been missed because of a communication error, the missing value(s) is replaced by dashes.
- When reading back, the Channel 1 relay (where fitted) will temporarily be switched off, and will return to its normal state 2 seconds after the read back has been completed.



The functionality of the EBDSM-PRM is controlled by a number of parameters which can be changed or programmed by any of the following devices:

- **UHS5** Infrared Handset. See below for programmable functions.
- **UNLCDHS** Infrared Handset (with LCD). See user guide for full programming details.

For most basic programming operations the UHS5 handset can be used and the following procedures are based on using this device.

Point the handset at the Sensor and send the required programming commands to the unit as shown below.

Valid commands will be indicated by a red LED flash. See page 1 for details of other LED responses.

Note: other functions on the UHS5 which are not shown below are not applicable to this product.

Parameter Name	Default Value	Number of Shift key presses				UHS5 Handset Graphics	Description
		0 SHIFT 1 SHIFT 2	1 SHIFT 1 SHIFT 2	2 SHIFT 1 SHIFT 2	3 SHIFT 1 SHIFT 2		
Button Activation							
On		On					Turn lights on.
Off		Off					Turn lights off.
Walk test	Off	On	Off				When set to On this causes a red LED to flash on the sensor when it detects movement. Use this feature to check for adequate sensitivity levels.
Time Out (Time adjustment)	20 mins	1, 10 & 20 minutes	5, 15 & 30 minutes	10 seconds			Once the detector is turned on, this value sets how long the lights will stay on once movement has ceased.
Lux on level (Switch level on)	9	2, 5 & 7	4, 6 & 9				Lux level setting to prevent the luminaires being switched on if the ambient light level is sufficient (adjustable between 1 and 9). The luminaires will always be switched on at level 9.
Lux off level (Switch level off)	9	2, 5 & 7	4, 6 & 9				Lux level setting to switch the luminaires off during occupancy if the ambient light level goes above the setting (adjustable between 1 and 9). Level 9 will always keep the lights on. This setting can be used for "window row switching". <i>Note: the Lux Off Level value must always be greater than the Lux On Level value.</i>
Sensitivity	9	1, 5 & 9	3, 6 & 8				Sensitivity level for detecting movement. 1 = low sensitivity 9 = high sensitivity
Defaults				D			Returns the unit to the default settings.
Presence / Absence	Presence	Presence	Absence				Presence mode allows the output to turn on when movement is detected and off when movement ceases. Absence mode allows the output to turn off when movement ceases, but must be manually turned on first.
Shift							Use this button to select the settings in red and blue signified by the 'Shift 1' and 'Shift 2' LEDs

Fault finding

What if the load does not turn ON?

- Check that the live supply to the circuit is good.
- Check that the load is functioning by bypassing the sensor (e.g. link terminals **L** and **L/ Out** on Channel1).
- If the detection range is smaller than expected, check the diagram on page 2. Rotating the sensor slightly may improve the detection range.

HINT: The Walk Test LED function can be used to check that the unit is detecting movement in the required area.

What if the load does not turn OFF?

- Ensure that the area is left unoccupied for longer than the Time Out Period.
- Ensure that the sensor is not adjacent to circulating air, heaters or lamps.

Advanced programming

Parameter Name	Default Value	Range / Options	Description	UHS5	UNLCDHS
Detector Parameters					
Walk Test LED	Off	On or Off	When set to On this causes a red LED to flash on the sensor when it detects movement. Use this feature to check for adequate sensitivity levels.	✓	✓
Time Out (Time adjustment)	20 minutes	0-99 minutes	Once the detector is turned on, this value sets how long the lights will stay on once movement has ceased. Select 0 for 10 second delay – use for commissioning only.	✓	✓
Manual Time Out	10 minutes	0-99 minutes	When a manual operation occurs, either via the switch input or the infrared, it invokes the timeout period. Example 1: a detector in presence mode has a detector timeout of 15 minutes and a manual timeout of 3 minutes. When the user leaves the room they press the off button. The sensor will revert to automatic after 3 minutes, and then walking back in the room will turn the lights on. Example 2: using the settings above, the user turns the lights off (say for a presentation) but stays in the room. Every time a movement is detected, the manual timeout period is re-triggered, but when it doesn't pick up for the short timeout period, the sensor will timeout and revert to automatic. This means the lights may turn on inadvertently during the presentation, if the occupants are still for the manual timeout period, so adjust the timing carefully.	✗	✓
Sensitivity On	9	1 (min) to 9 (max)	Sensitivity level for detecting movement when the detector is already on. *UHS5 sets Sensitivity On and Off to the same value.	✓*	✓
Sensitivity Off	9	1 (min) to 9 (max)	Sensitivity level for detecting movement when the detector is off. *UHS5 sets Sensitivity On and Off to the same value.	✓*	✓
Lux time	0	0 (disabled) 1-99 minutes	If the detector measures the lux level and decides that the output needs switching on or off as a consequence, the lux time must elapse first. If at any time during the timed delay the lux change reverses then the process is cancelled. Lux Time enables absence detection to be implemented with a lux off level set. When the button is pressed, the lights will go on, regardless of ambient light level. However, if there is sufficient ambient light, they will turn off again after the Lux Time. <i>Note that whenever the an external switch is pressed, whether in absence or presence mode, if the lights were out because of the lux level, they will be immediately turned on again for at least the Lux Time.</i>	✗	✓
Power Up State	On	On or Off	Select No for a 30 second delay on start up. If Yes is selected, there will be no delay on start up and the detector will always power up detecting.	✗	✓
Inhibit	4 seconds	1 to 999 seconds	When the detector turns off, a delay is instigated to prevent retriggering. In certain circumstances this delay may not be enough. This parameter allows the delay to be changed.	✗	✓
Factory default	-	-	Restores factory default settings	✓	✓

Switching functions					
Detection Mode	Presence	Presence or Absence	Presence mode allows the output to turn on when movement is detected and off when movement ceases. Absence mode allows the output to turn off when movement ceases, but must be manually turned on first.	✓	✓
Lux on level (Switch level on)	9	1 to 9 For a higher resolution a scale of 101-199 is available	Sets a minimum light level below which the PIR sensor is enabled, allowing lights to be turned on by movement. <i>Note: the Lux Level Off value must always be greater than the Lux Level On value.</i>	✓	✓
Lux off level (Switch level off)	9	1 to 9 For a higher resolution a scale of 101-199 is available	Sets a maximum light level above which the PIR sensor is disabled, preventing lights from being turned on by movement.	✓	✓

User Modes					
Override On	-	-	If the lights are off, sending the IR command will turn them on immediately and revert to automatic operation using the manual timeout period .	✓	✓
Override Off	-	-	If the lights are on, sending the IR command will turn them off immediately. After the manual timeout period (described above), the sensor will revert to automatic.	✓	✓
Cancel	-	-	Cancels the on or off override, returning the detector to normal operation.	✗	✓

Switch Input Modes					
1 position switch together	Default	-	Short press on, long press off.	✗	✓
2 position switch together	-	-	Short press on, short press off.	✗	✓

This page intentionally left blank

Technical data

Dimensions	See diagrams opposite
Weight	0.15kg
Supply Voltage	230VAC +/- 10%
Frequency	50Hz
Maximum Load	10A of lighting and/or ventilation including incandescent, fluorescent, compact fluorescent, low voltage (by switching the primary of transformer).
Power consumption	On 875mW, Off 895mW
Terminal Capacity	2.5mm ²
Temperature	-10°C to 35°C
Humidity	5 to 95% non-condensing
Material (casing)	Flame retardant ABS and PC/ABS
Type	Class 2
IP rating	40 without gasket. 54 with gasket.
Compliance	EMC-2004/108/EC LVD-2006/95/EC



EBDSM-PRM

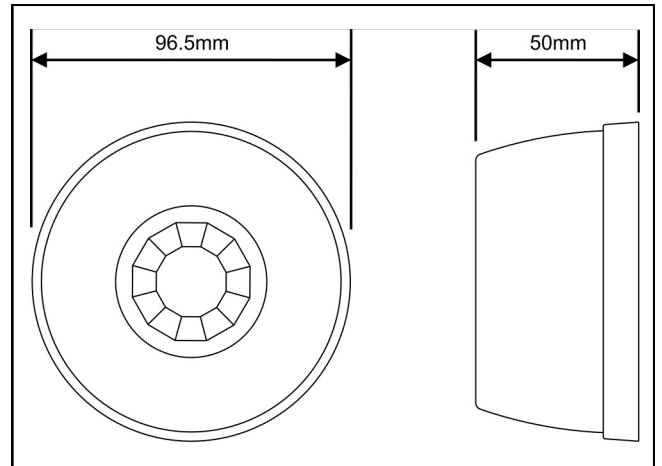

Part numbers

	Part number	Description
Detector	EBDSM-PRM	Ceiling PIR presence detector
Accessories	UHS5	Programming IR handset
	UNLCDHS	Universal LCD IR handset

IMPORTANT NOTICE!

This device should be installed by a qualified electrician in accordance with the latest edition of the IEE Wiring Regulations and any applicable Building Regulations.



C.P. Electronics Ltd

Brent Crescent
London
NW10 7XR
United Kingdom
Tel: + 44 (0) 333 900 0671
Fax: + 44 (0) 333 900 0674
www.cpelectronics.co.uk
enquiry@cpelectronics.co.uk

Due to our policy of continual product improvement CP Electronics reserves the right to alter the specification of this product without prior notice.

Ref: #WD603 Issue 1